

TT
185
.G86

WOODWORK FOR SECONDARY SCHOOLS

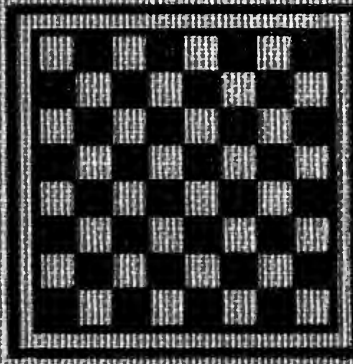

GRIFFITH



Class TT 185

Book 1 G 86

Copyright N^o _____

COPYRIGHT DEPOSIT.



WOODWORK
FOR
SECONDARY SCHOOLS

A TEXT-BOOK FOR
HIGH SCHOOLS AND COLLEGES, PREVOCAIONAL AND
ELEMENTARY INDUSTRIAL SCHOOLS

BY

IRA SAMUEL GRIFFITH
CHAIRMAN OF THE MANUAL ARTS DEPARTMENT
THE UNIVERSITY OF MISSOURI



THE MANUAL ARTS PRESS
PEORIA, ILLINOIS

TT 185
G86

COPYRIGHT, 1916

—
IRA SAMUEL GRIFFITH

415
AUG 30 1916

16-17162

©CIA 437458

201

PREFACE.

The aim of this book is to provide in text form the essentials of woodwork as usually taught in secondary schools. Manifestly, in a book of this size no one subject can be treated exhaustively. Nor is such treatment necessary to fulfill the purpose of the book, which is to provide the elements of subject-matter for general experience in various lines of woodwork rather than extended experience in some one line. It is confidently expected that the content will be found sufficiently complete for the purpose intended.

Much of the subject-matter, should limitations of time or equipment prevent its use in connection with specific shop experience, may be assigned for reading and study from the purely "informational" point of view. Such assignments, if made so that they shall have some connection with the shopwork, will serve to broaden the pupil's "outlook," giving to the specific shop experiences a "setting" calculated to greatly increase the understanding of their meaning.

This text presupposes a knowledge of elementary tool processes, such as are to be found in well organized grade school work, as described in "Essentials of Woodworking," by the same author. However, owing to the lack of any general agreement as to the dividing line between grade school and high school, there will be found included in this text those parts of "Essentials of Woodworking" which observation has shown are frequently not covered in grade schools of good standing. Such duplication

makes possible the meeting of diverse conditions now to be found in the division of subject-matter between grade school and high school.

The use of woodworking machines, with the exception of the lathe, by large classes of freshmen is not recommended. The chapter on Woodworking Machines is included in the text for the use of such classes as can be organized with sufficiently small numbers to allow the instructor to give close and continuous attention to the machines. There is no reason, however, why much of such matter may not be read and studied by freshmen as they secure shop experience with the hand tools. A freshman who does not expect to take advanced shopwork in wood will be profited by knowing how much of his hand tool work is duplicated by machines in a way which makes possible cheaper and, if well done, equally good production.

It has been found impracticable to treat the subject of carpentry as a chapter of this text. Then, too, because of physical limitations, carpentry can hardly find a place so nearly universal in the general school curriculum as the more strictly bench subjects. For these reasons carpentry has been treated by the author in a separate text.

Credit is due to John R. Frazier, of Bradley Polytechnic Institute, for the great majority of pen drawings, which assist so greatly in making clear the text; to C. E. Abbott, of the University of Missouri, for writing the first draft of the chapter on Pattern-making; to Harry L. King, of the Yeatman High School, St. Louis, for the first draft of the chapter on Inlaying and Wood-Carving; to Prof. Chas. A. Bennett, of Bradley Polytechnic Institute, Peoria, for valuable additional contributions of both illustrations and text, sections 201, 202, to the same chapter; to Harry L. Hurff, of Bradley Polytechnic Institute, for the first draft

of the chapter on Woodworking Machinery; to Marshall H. Brigham and N. C. Murray, of the University of Missouri, for generous assistance in arranging materials for photographic illustrations, which, in the main, were the work of James Barham, Agricultural Experiment Station photographer.

IRA S. GRIFFITH.

Columbia, Missouri
July, 1915

CONTENTS

CHAPTER I.—Common Woods	11
1, Classification. <i>Coniferous woods</i> ; 2, Cedar; 3, Cypress; 4, Pine; 5, Spruce. <i>Broad-leaved woods</i> ; 6, Ash; 7, Basswood; 8, Birch; 9, Butternut; 10, Cherry; 11, Chestnut; 12, Elm; 13, Gum; 14, Hickory; 15, Maple; 16, Oak; 17, Sycamore; 18, Tulip wood; 19, Walnut.	
CHAPTER II.—Tools and Processes	24
20, Flexible folding rule; 21 Pattern-makers' shrinkage rule; 22, Framing square; 23, Octagon scale; 24, Brace measure table; 25, Essex board measure table; 26, Hundredths scale; 27, Rafter table; 28, Determining rafter length by scaling; 29, Plumb and level; 30, Mortise gages; 31, Butt gage; 32, Pattern-maker's gage; Gage attachment; 33, Twist drill gage; 34, Miter square; Combination square; 35, Spring dividers; 36, Calipers; 37, Trammel points or beam compass; 38, Lumberman's board stick; 39, Pattern-maker's knife; 40, Butt chisel; 41, Mortise chisel; 42, Corner chisel; 43, Wood-turning tools; 44, Turner's gouge; 45, Skew or turner's chisel; 46, Scraping tools; 47, Carving tools; 48, Carver's punch; 49, Circular plane; 50, Rabbet or rebate plane; 51, Rabbet or filletster plane; 52, Dado plane; 53, Plow and matching plane; 54, Universal plane; 55, Router plane; 56, Scraper plane; 57, Handled scraper; 58, Veneer scraper; 59, Core-box plane; 60, Drawing knife; 61, Expansion or extension bit; 62, Nut augers; 63, Angular boring attachment; 64, Extension bit holder; 65, Breast drill; 66, Hand drill; 67, Automatic hand drill; 68, Spiral screwdriver; 69, Awls; 70, Wrecking bar; 71, Nail puller; 72, Glass cutter; 73, Files and rasps; 74, File cleaner; 75, Belt punch; 76, Plug cutter; 77, Screw and plug bit; 78, Washer cutter; 79, Emery wheel dresser; 80, Sharpening auger bits; 81, Forstner auger bit; 82, Sharpening saws; 83, Sharpening scrapers; 84, Sharpening lathe tools; 85, Sharpening carving tools; 86, Modeling; 87, Glue pots; 88, Surface table.	

CHAPTER III.—Woodworking Machines76

89, Introductory; 90, Order of procedure in the use of machines; 91, Swing cut-off saw; 92, Operating a swing cut-off saw; 93, Hand planer or jointer; 94, Setting up a hand planer or jointer; adjustments; 95, Cutter heads; set-up and fitment of knives; 96, Operation of a hand planer or jointer; 97, Jointer guard; 98, Planer or surfacer; 99, Operation of a surfacer; 100, Adjustments on a surfacer; 101, Circular saws; 102, Operation of a universal saw; 103, Cutting tenons with a universal saw; 104, Cutting wedges on a universal saw; 105, Kerfing a cove for molding or core-box; 106, Table for set-up of universal saw for compound miters; 107, Grooving and dado or gaining heads for universal saw; 108, Circular miter saws; 109, Fitting and filing circular saws; 110, The band saw; 111, Operation of a band saw; 112, Re-sawing attachment for band saw; 113, Filing and fitting a band saw; 114, Brazing small band saws; 115, The scroll saw; 116, Boring machine; 117, Operation of a boring machine; 118, Mortiser; 119, Operation of a hollow chisel mortiser; 120, Tenoner; 121, The shaper; 122, The lathe; 123, Sanders; 124, The belt sander; 125, Disc and spindle sander; 126, The trimmer; 127, Miter plane and chute board; 128, Miter-box; 129, Picture frame miter-box and nailing clamp; 130, Automatic grinder; 131, The grindstone; 132, Power transmission; 133, Splicing belts; 134, Selection of belting; 135, Babbitting bearings; 136, Dust exhaust system; 137, Shaft drive vs. individual motor drive; 138, Calculating speeds and diameters of pulleys, saws, grindstones, etc.

CHAPTER IV.—Joinery152

139, Joinery; 140, General directions for joinery; 141, Dado; 142, Directions for dado; 143, Cross-lap joint; 144, Directions for cross-lap joint; 145, Directions for cross-lap joint—*second method*; 146, Glue joint; 147, Directions for glue joint; 148, Doweling; 149, Directions for doweling; 150, Keyed tenon-and-mortise; 151, Directions for key; 152, Directions for tenon; 153, Directions for mortise; 154, Directions for mortise in the tenon; 155, Blind mor-

tise-and-tenon; 156, Directions for tenon; 157, Directions for laying out mortise; 158, Directions for cutting mortise; 159, Directions for cutting mortise—*second method*; 160, Miter joint; 161, Directions for miter joint; 162, Dovetail joint; 163, Directions for dovetail joint; 164, Additional joints; 165, Hopper joint; 166, Doweled joint; 167, Pinned mortise-and-tenon; 168, Coped joint.

CHAPTER V.—Wood Turning185

169, Turning between centers; 170, Centering the stock; 171, Adjusting the tool rest; 172, Position of the operator; 173, Use of the large gouge; 174, Use of the outside calipers; 175, Use of the large skew; 176, Cutting off; Use of parting tool; 177, Use of the toe of the skew to dress off an end; 178, Heel of the skew used to cut a shoulder; 179, Long taper cuts; 180, Laying off consecutive measurements; 181, Making full v-grooves; 182, Short convex cuts; beads; 183, Concave cuts; 184, Long convex cuts; 185, Face-plate and chuck work; 186, Face-plates; Preparation of the stock; 187, Rough scraping; 188, Convex and concave scraping; 189, Chucks; their use; 190, Sandpapering and finishing.

CHAPTER VI.—Inlaying and Wood-Carving215

191, Inlaying; general considerations; 192, Directions for forming and fitting inlays of irregular outline; 193, strings and bandings; 194, Directions for building up a typical banding; 195, Directions for laying strings and bandings; 196, Directions for marquetry; 197, Finishing; 198, Wood-carving; 199, General directions; 200, Line carving; 201, Ribbon carving; 202, Grounding out and molding; 203, Modeling; 204, Light and shade; 205, Finishing carvings; 206, Pierced ornamentation.

CHAPTER VII.—Wood Finishing239

207, Wood finishes; 208, Brushes; 209, General directions for using brush; 210, Fillers; 211, Filling with paste filler; 212, Stains; 213, Waxing; 214, Varnishes; 215, Shellac; 216, Shellac finishes; 217, Oil or copal varnishes; 218, Flowing copal varnish; 219, Typical finishes for coarse-

grained woods; 220, Patching; 221, Painting; 222, Wood finishing recipes.

CHAPTER VIII.—Furniture Construction254

223, General discussion; 224, Designing; 225, Structural details; 226, Posts or legs; 227, Corner fastenings; 228, Slats, splats or splads; balusters; 229, Chairs; 230, Patching; 231, Curved work; 232, Veneering; 233, Clamping table tops; 234, surfacing table tops; 235, Clamping framed structures; 236, Adjusting the clamps; clamping a section; 237, Assembling the sections; 238, Scribing the posts; 239, Clamping miters; 240, Fastening tops; 241, Drawer runners and guides; 242, Drawer construction; 243, Directions for rabbeted corner; 244, Directions for dovetail corner; 245, Directions for drawer; 246, Paneling; 247, Cutting grooves; 248, Haunched mortise-and-tenon; 249, Rabbeting; 250, Fitting a door; 251, Hinging a door; 252, Locks; 253, Carcase construction; 254, Shelving; 255, Rods; 256, Templets; 257, Period furniture; 258, Moldings; 259, Simple upholstering; 260, Spring or box seat; 261, Woven reed seat; 262, Rush fiber seat; 263, Cane seating.

CHAPTER IX.—Pattern Making320

264, Pattern-making; 265, Materials; 266, Flasks; 267, Molding operations; 268, Determining factors in the construction of a pattern; 269, Molding sand; 270, Pattern draft; 271, Shrinkage; 272, Shrinkage vs. rappage; 273, Double shrinkage; 274, Finish; 275, Making a "lay-out"; 276, Order of procedure; 277, Fillets; 278, Cores; core-prints; core-boxes; 279, Vertical cores and core-prints; 280, Horizontal cores; 281, Balanced cores; 282, Stop-off cores; 283, Stop-off core-box; 284, Wood face-plates; 285, Segments; 286, Lap joint for six-arm pattern; 287, Laying out arms; 288, Forming arms; 289, Spur gear teeth; 290, Bevel gears; 291, Split patterns; dowels; 292, Turning split patterns; 293, Tee-pipe fittings; 294, Elbow; offset; return bend; 295, Loose pieces; 296, Burning iron; 297, Affixing letters or numerals; 298, Varnishing patterns.

CHAPTER I.

COMMON WOODS.

1. **Classification.**—According to botanical classification, woods belong to the Flowering Plants (Phanerogamia). Classified further we have:

- (1) Naked seeds (gymnosperms)
 1. Palm ferns, etc. (cycadaceae)
 2. Joint firs (gnetaceae)
 3. Pines, firs, etc. (conifers)
- (2) Fruits (angiosperms)
 1. One-seed-leaf (monocotyledons)
(bamboos, palms, grasses, etc.)
 2. Two-seed-leaf (dicotyledons)
 - a. Herbs
 - b. Broad-leaved trees
(oak, ash, elm, etc.)

Conifers and broad-leaved trees are alike in that they add a new layer of wood each year which covers the old wood of root, trunk, and branch. They are known as exogens—outward growers.

In woods such as the palms, bamboos, and yuccas, growth is made from within.

The new wood strands mingle with the old and cause the cross sections to appear dotted, Fig. 1. Trees of this class—endogens—after some years of growth form harder wood near the surface with younger and softer growth toward the center—quite the reverse of the

exogens. There are no annual rings. Growth takes place mainly at the top.

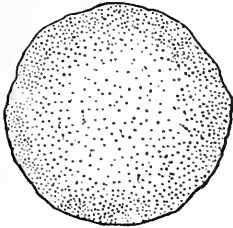

FIG. 1.
SECTION OF ENDOGEN.

Other classifications, such as "deciduous," "hard woods," "evergreens," "soft woods," are in common use but are not very accurate.

Deciduous trees are the broad-leaved trees and are so called because they lose their leaves in the fall. Broad-leaved trees are also called hard woods.

Conifers are called evergreens because their needle-shaped leaves remain green on the tree the year around. They are also known as soft woods.

Most of our timber is furnished by (1) the needle-leaved conifers and (2) the broad-leaved trees.

CONIFEROUS WOODS.¹

2. **Cedar.**—Fig. 2. Light, soft, stiff, not strong, of fine texture; sap and heartwood distinct, the former lighter, the latter a dull grayish brown, or red. The wood seasons rapidly, shrinks and checks but little, and is very durable. Used like soft pine, but owing to its great durability preferred for shingles, etc. Small sizes used for posts, ties, etc. (Since almost all kinds of wood are used for fuel and charcoal, and in the construction of fences, barns, etc., the enumeration of these uses has been



FIG. 2. CEDAR.

¹The descriptive matter on woods is quoted, by permission, from a report of the Division of Forestry, U. S. Department of Agriculture, Washington, D. C.—Bulletin No. 10, Timber—to which the student is referred for further information about trees.

omitted in this list.) Cedars usually occur scattered, but they form, in certain localities, forests of considerable extent.

3. Cypress.—Fig 3. Cypress wood in appearance, quality, and uses is similar to white cedar. “Black cypress” and “white cypress” are heavy and light forms of



FIG. 3. CYPRESS.



FIG. 4. PINE.

the same species. The cypress is a large deciduous tree occupying much of the swamp and overflow land along the coast and rivers of the Southern States.

4. Pine.—Fig. 4. Very variable, very light and soft in “soft” pine, such as white pine; of medium weight to heavy and quite hard in “hard” pine, of which longleaf or Georgia pine is the extreme form. Usually it is stiff, quite strong, of even texture, and more or less resinous. The sapwood is yellowish white; the heartwood, orange brown. Pine shrinks moderately, seasons rapidly and without much injury; it works easily; is never too hard to nail (unlike oak or hickory); it is mostly quite durable, and if well seasoned is not subject to the attacks of boring insects. The heavier the wood, the darker, stronger and harder it is, and the more it shrinks and checks. Pine is

used more extensively than any other kind of wood. It is the principal wood in common carpentry, as well as in all heavy construction, bridges, trestles, etc. It is used also in almost every other wood industry, for spars, masts, planks, and timbers in ship building, in car and wagon construction, in cooperage, for crates and boxes, in furniture work, for toys and patterns, railway ties, water pipes, excelsior, etc. Pines are usually large trees with few branches, the straight, cylindrical, useful stem forming by far the greatest part of the tree.

5. **Spruce.**—Fig. 5. Resembles soft pine, is light, very



FIG. 5. SPRUCE.

soft, stiff, moderately strong, less resinous than pine; has no distinct heartwood, and is of whitish color. Used like soft pine, but also employed as resonance wood and preferred for paper pulp. Spruces, like pines, form extensive forests; they are more frugal, thrive on thinner soils, and bear more shade, but usually require a more humid climate. "Black" and "white" spruce, as ap-

plied by lumbermen, usually refer to narrow and wide ringed forms of black spruce.

BROAD-LEAVED WOODS.

6. **Ash.**—Fig 6. Wood heavy, hard, strong, stiff, quite tough, not durable in contact with soil, straight grained, rough on the split surface and coarse in texture. The wood shrinks moderately, seasons with little injury,

stands well and takes a good polish. In carpentry ash is used for finishing lumber, stairways, panels, etc.; it is used in shipbuilding, in the construction of cars, wagons, carriages, etc., in the manufacture of farm implements, machinery, and especially furniture of all kinds, and also for harness work; for barrels, baskets,* oars, tool



FIG. 6. ASH.

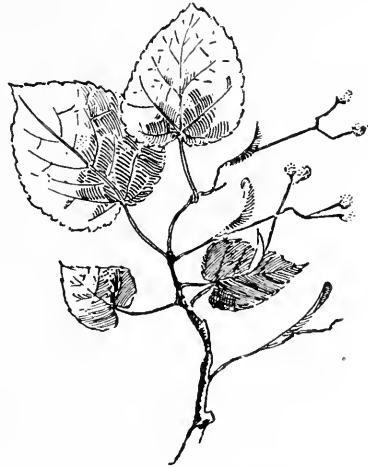

FIG. 7. BASSWOOD.

handles, hoops, clothespins, and toys. The trees of the several species of ash are rapid growers, of small to medium height with stout trunks; they form no forests, but occur scattered in almost all broad-leaved forests.

7. **Basswood.**—Fig. 7. (Lime tree, American linden, lin, bee tree): Wood light, soft, stiff but not strong, of fine texture, and white to light brown color. The wood shrinks considerably in drying, works and stands well; it is used in carpentry, in the manufacture of furniture and woodenware, both turned and carved, in cooperage, for toys, also for paneling of car and carriage bodies. Medium to large sized trees, common in all northern broad-leaved forests; found throughout the eastern United States.

8. **Birch.**—Fig. 8. Wood heavy, hard, strong, of fine texture; sapwood whitish, heartwood in shades of brown with red and yellow; very handsome, with satiny luster, equaling cherry. The wood shrinks considerably in drying, works and stands well and takes a good polish, but is not durable if exposed. Birch is used for finishing lumber in building, in the manufacture of furniture, in woodturnery, for spools, boxes, wooden shoes, etc., for shoe lasts and pegs, for wagon hubs, ox yokes, etc., also in wood-carving. The birches are medium sized trees, form extensive forests northward and occur scattered in all broad-leaved forests of the eastern United States.

9. **Butternut.**—Fig. 9. (White Walnut.) Wood very similar to black walnut, but light, quite soft, not strong and of light brown color. Used chiefly for finishing



FIG. 8. BIRCH.



FIG. 9. BUTTERNUT.

lumber, cabinet-work and cooperage. Medium sized tree, largest and most common in the Ohio basin; Maine to Minnesota and southward to Georgia and Alabama.

10. **Cherry.**—Fig. 10. Wood heavy, hard, strong, of fine texture; sapwood yellowish white, heartwood reddish to brown. The wood shrinks considerably in drying, works and stands well, takes a good polish, and is much

esteemed for its beauty. Cherry is used chiefly as a decorative finishing lumber for buildings, cars and boats, also for furniture and for turnery. It is becoming too costly for many purposes for which it is naturally suited.



FIG. 10. CHERRY.



FIG. 11. CHESTNUT.

The lumber-furnishing cherry of this country, the wild black cherry, is a small to medium sized tree, scattered thru many of the broad-leaved woods of the western slope of the Alleghanias, but found from Michigan to Florida and west to Texas.

11. Chestnut.—Fig. 11. Wood light, moderately soft, stiff, not strong, of coarse texture; the sapwood light, the heartwood darker brown. It shrinks and checks considerably in drying, works easily, stands well, and is very durable. Used in cabinet-work, cooperage, for railway ties, telegraph poles, and locally in heavy construction. Medium sized tree very common in the Alleghanias, occurs from Maine to Michigan and southward to Alabama.

12. Elm.—Fig. 12. Wood heavy, hard, strong, very tough; moderately durable in contact with the soil; commonly cross-grained, difficult to split and shape, warps and checks considerably in drying, but stands well if

properly handled. The broad sapwood whitish, heart brown, both shades of gray and red; on split surface rough, texture coarse to fine, capable of high polish. Elm



FIG. 12. ELM.

is used in the construction of cars, wagons, etc., in boat and ship building, for agricultural implements and machinery; in rough cooperage, saddlery, and harness work, but particularly in the manufacture of all kinds of furniture,

where the beautiful figures, especially of the tangential or bastard section, are just beginning to be duly appreciated. The elms are medium to large sized trees, of fairly rapid growth, with stout trunk, form no forests of pure growth, but are found scattered in all the broad-leaved woods of our country.

13. Gum.—This general term refers to two kinds of wood, usually distinguished as sweet or red gum, and sour, black, or tupelo gum, the former being a relative of the witch-hazel, the latter belonging to the dogwood family.

Sweet Gum. Fig. 13. (Red gum, liquidambar); wood rather heavy, rather soft, quite stiff and strong, tough, commonly cross-grained, of fine texture; the broad sapwood whitish, the heartwood reddish brown; the wood warps and shrinks considerably, but does not check badly, stands well when fully seasoned, and takes good polish. Sweet gum is used in carpentry, in the manufacture of furniture, for cut veneer, for wooden plates,

plaques, baskets, etc., also for wagon hubs, hat blocks, etc. A large sized tree, very abundant, often the principal tree in the swampy parts of the bottoms of the Lower Mississippi Valley; occurs from New York to Texas and from Indiana to Florida.

14. Hickory.—Fig. 14. Wood very heavy, hard and strong, proverbially tough, of rather coarse texture, smooth and of straight grain. The broad sapwood white,



FIG. 13. GUM.



FIG. 14. HICKORY.

the heart reddish nut brown. It dries slowly, shrinks and checks considerably, is not durable in the ground or if exposed, and, especially the sapwood, is always subject to the inroads of boring insects. Hickory excels as carriage and wagon stock, but is also extensively used in the manufacture of implements and machinery, for tool handles, timber pins, for harness work and cooperage. The hickories are tall trees with slender stems, never form forests, occasionally small groves, but usually occur scattered among other broad-leaved trees in suitable localities.

15. Maple.—Fig. 15. Wood heavy, hard, strong, stiff, and tough, of fine texture, frequently wavy grained, thus giving rise to “curly” and “blister” figures; not durable



FIG. 15. MAPLE.

in the ground or otherwise exposed. Maple is creamy white, with shades of light brown in the heart; shrinks moderately, seasons, works and stands well, wears smoothly and takes fine polish. The wood is used for ceiling, flooring, paneling, stairway and other finishing lumber in house, ship and car

construction; it is used for the keels of boats and ships, in the manufacture of implements and machinery, but especially for furniture, where entire chamber sets of maple rival those of oak. Maple is also used for shoe lasts and other form blocks, for shoe pegs, for piano actions, school apparatus, for wood type in show bill printing, tool handles, wood-carving, turnery and scroll work.

The maples are medium sized trees, of fairly rapid growth; sometimes form forests and frequently constitute a large proportion of the arborescent growth.

16. Oak.—Fig. 16. Wood very variable, usually very heavy and hard, very strong and tough, porous, and of coarse texture; the sapwood whitish, the heart “oak” brown to reddish brown. It shrinks and checks badly.

giving trouble in seasoning, but stands well, is durable and little subject to attacks of insects. Oak is used for many purposes: in shipbuilding, for heavy construction, in common carpentry, in furniture, car and wagon work, cooperage, turnery, and even in wood-carving; also in the manufacture of all kinds of farm implements, wooden mill machinery, for piles and wharves, railway ties, etc. The oaks are medium to large sized trees, forming the predominant part of a large portion of our

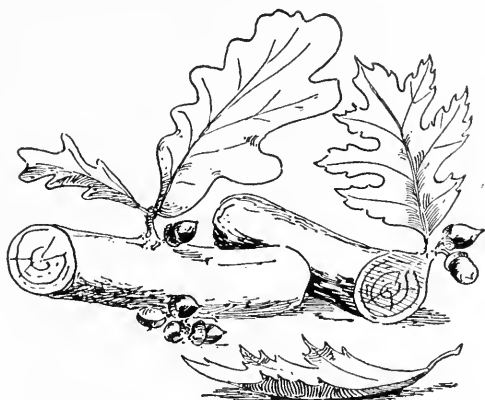

FIG. 16. OAK.

broad-leaved forests, so that these are generally "oak forests" though they always contain a considerable proportion of other kinds of trees. Three well marked kinds, white, red, and live oak are distinguished and kept separate in the market. Of the two principal kinds, white oak is the stronger, tougher, less porous, and more durable. Red oak is usually of coarser texture, more porous, often brittle, less durable, and even more troublesome in seasoning than white oak. In carpentry and furniture work, red oak brings about the same price at present as white oak. The red oaks everywhere accompany the white oaks, and like the latter, are usually represented by several species in any given locality. Live oak, once largely employed in shipbuilding, possesses all the good qualities (except that of size) of the white oak, even to a greater degree. It is one of the heaviest, hardest and most durable building timbers of this country; in structure it resembles the red oak but is much less porous.

17. **Sycamore.**—Fig. 17. (Button wood, button-ball tree, water beech): Wood moderately heavy, quite hard, stiff, strong, tough, usually cross-grained, of coarse texture, and white to light brown color; the wood is hard to split and work, shrinks moderately, warps and checks considerably but stands well. It is used extensively for



FIG. 17. SYCAMORE.



FIG. 18. TULIP WOOD.

drawers, backs, bottoms, etc., in cabinet-work, for tobacco boxes, in cooperage, and also for finishing lumber, where it has too long been underrated. A large tree, of rapid growth, common and largest in the Ohio and Mississippi valleys, at home in nearly all parts of the eastern United States.

18. **Tulip Wood.**—Fig. 18. Tulip tree. (Yellow poplar, white wood): Wood quite variable in weight, usually light, soft, stiff but not strong, of fine texture, and yellowish color; the wood shrinks considerably, but seasons without much injury; works and stands remarkably well. Used for siding, for paneling, and finishing lumber in house, car and shipbuilding, for sideboards and panels of wagons and carriages; also in the manufacture of furniture, implements and machinery, for pump logs, and almost every kind of common woodenware, boxes,

shelving, drawers, etc. An ideal wood for the carver and toy man. A large tree, does not form forests, but is quite common, especially in the Ohio basin; occurs from New England to Missouri and southward to Florida.

19. Walnut.—Fig. 19. Black walnut. Wood heavy, hard, strong, of coarse texture; the narrow sapwood whitish, the heartwood chocolate brown. The wood shrinks moderately in drying, works and stands well, takes a good polish, is quite handsome, and has been for a long time the favorite cabinet wood in this country. Walnut formerly used even for fencing, has become too



FIG. 19. WALNUT.

costly for ordinary uses, and is today employed largely as a veneer, for inside finish and cabinet-work, also for turnery, for gunstocks, etc. Black walnut is a large tree, with stout trunk, of rapid growth, and was formerly quite abundant throughout the Alleghany region, occurring from New England to Texas, and from Michigan to Florida.

CHAPTER II.

TOOLS AND PROCESSES.¹

20. Flexible Folding Rule.—The flexible folding rule is used by carpenters and others where distances to be

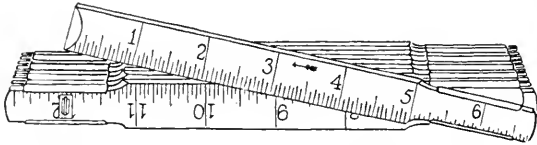

FIG. 20. FLEXIBLE FOLDING RULE.

measured usually exceed two feet. It is made of flexible hard wood with steel riveted joints. Each joint contains a stiff spring which holds the parts in position when open. It can be obtained in four, six and eight foot lengths. Fig. 20.

The rule shown in Fig. 21 differs from the ordinary flexible rule in that it has a sliding extension which makes possible inside calipering. This will be found very convenient in all work requiring inside measurements. Such rules will measure four or six feet plus the length of the extension.

21. Pattern-Maker's Shrinkage Rule.—All metals, when cast, shrink in cooling. The amount of shrinkage depends upon the kind of metal, the thickness of the piece cast, and the conditions under which it is cast.

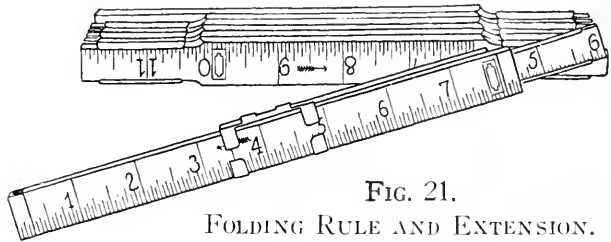

FIG. 21.

FOLDING RULE AND EXTENSION.

¹No attempt is made to list in this chapter such tools as are ordinarily made use of in grammar grade woodworking.

Under ordinary conditions, where the thickness of the casting is about 1", the average shrinkage is as follows for the following metals: Cast iron, $\frac{1}{8}$ "; steel, $\frac{1}{4}$ "; brass, $\frac{3}{16}$ "; tin, $1/12$ ". If the castings are thicker the shrinkage will average less; if thinner, more under the same conditions of casting.

In order to allow for this shrinkage patterns must be made correspondingly larger than the finished casting is to be. Shrinkage rules are graduated to make such allowances for the various metals used in common foundry practice. The figures on a shrink rule refer to the dimensions of the casting, but the spacings are such as will give the proper size for the pattern. Fig. 22. Thus, a rule for use in making patterns to be cast in iron will have a shrinkage allowance of $\frac{1}{8}$ " per foot, making the rule $24\frac{1}{4}$ " long with graduations into 8ths, 16ths, 32nds and 64ths. A shrinkage rule for steel will have a length of $24\frac{1}{2}$ ", and brass $24\frac{3}{8}$ ".



FIG. 22. PATTERN-MAKER'S SHRINKAGE RULE.

22. Framing Square.—The framing square consists of two parts, the blade which is 24" long and the tongue which is either 16" or 18" long. The blade is 2" wide and the tongue is $1\frac{1}{2}$ ". Such squares are variously marked. In addition to the linear graduations, there will usually be found tables of various sorts, different makes having different tables and arrangements. That side of a square having the maker's name stamped thereon is considered the face.

23. Octagon Scale.—Along the middle of the face of the tongue of certain squares will be found a scale like

that shown in Fig. 23. This is known as an octagon or eight-square scale, and is used as its name implies for laying out octagons.

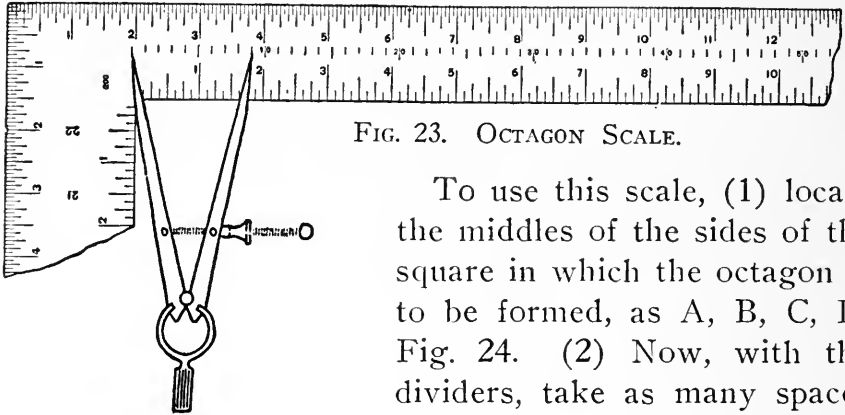

FIG. 23. OCTAGON SCALE.

To use this scale, (1) locate the middles of the sides of the square in which the octagon is to be formed, as A, B, C, D, Fig. 24. (2) Now, with the dividers, take as many spaces from the scale as there are inches in the width of the square and lay off this space on either side of the middle points just located, as at 1, 2, 3, 4, 5, 6, 7, 8. Connect these points as indicated by the dotted lines. This gives an eight-sided figure which is sufficiently accurate for all practical purposes.

24. Brace Measure Table.—This table enables the carpenter to determine quickly the length of a brace when

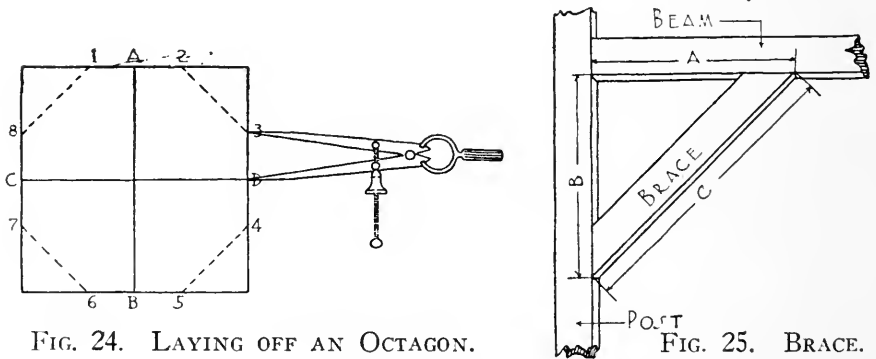

FIG. 24. LAYING OFF AN OCTAGON.

FIG. 25. BRACE.

its extremities are certain equal distances from the intersection of post and beam, A and B, Fig. 25.

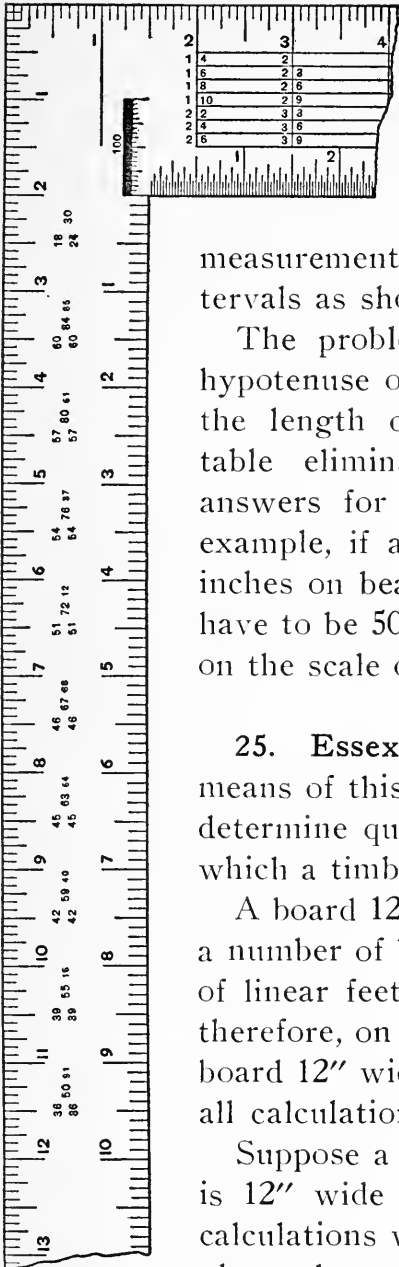

FIG. 26. BRACE MEASURE TABLE.

As a rule, braces do not have to be of any very definitely prescribed lengths. For this reason the table gives runs (runs are the horizontal and vertical measurements, A and B, Fig. 25) with intervals as shown in Fig. 26.

The problem is one of solving for the hypotenuse of a right triangle having given the length of the two equal sides. The table eliminates figuring by giving the answers for sides of certain values. For example, if a brace is to have a run of 36 inches on beam and on post, its length will have to be 50.91 inches, which will be found on the scale or table thus: $\begin{matrix} 36 & 50 & 91 \\ & 36 & \end{matrix}$

25. Essex Board Measure Table.—By means of this table, Fig. 27, it is possible to determine quickly the number of board feet which a timber or board contains.

A board 12" wide will contain, if 1" thick, a number of board feet equal to the number of linear feet in its length. The figure 12, therefore, on the outer edge, represents a 1" board 12" wide, and is the starting point for all calculations.

Suppose a board is being surveyed which is 12" wide and 8 ft. long. Without any calculations we know its board measure. A glance down the column of figures under the 12, on the square, until we reach the figure

representing the length of the board in feet verifies our answer. Suppose, now, the board is 8" wide and 14 ft. long. We again look under the 12 and cast the eye down the column until we reach the figure 14, the number of feet in length, then following along this line to the left until we reach a point directly under the figure 8 of the edge graduations representing the width in inches, we find 9 to the left of the cross-line and 4 to the right of the same line, which means 9 and 4/12 ft. for a 1" board. If the board were 2" in thickness, the total would be obtained by multiplying the result just obtained by 2.

If a board is wider than 12", then the result will be found to the right of the 12" mark.

Suppose a board is 18 ft. long. Since this number is not to be found under the figure 12, it will be necessary to find the number of feet in two boards whose combined lengths equal 18 ft., and then combine the results.

26. Hundredths Scale.—At the intersection of the blade and tongue of the framing square of Figs. 26 and 27 is shown a 1/100 scale. This scale is used in connection with the scale along the inner edge of the tongue. A sharp pointed pair of dividers will be used to

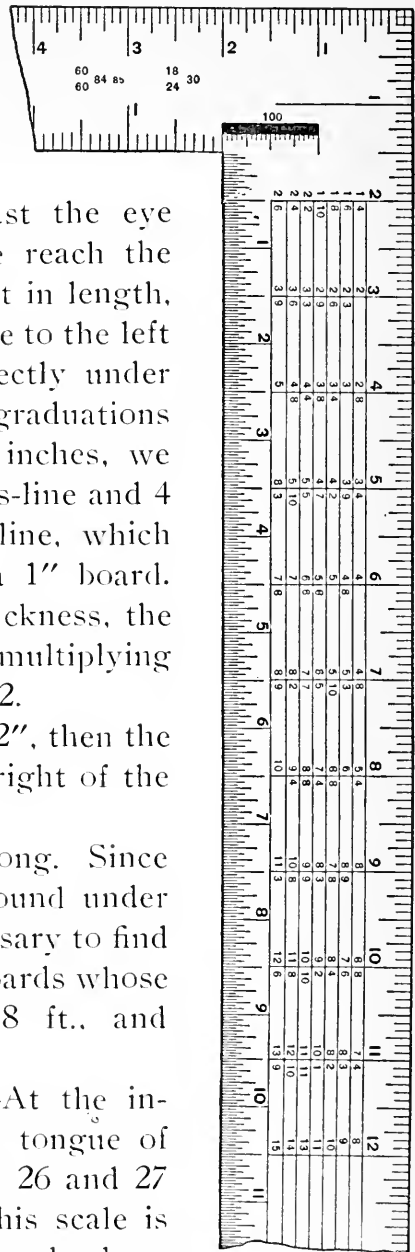

FIG. 27. BOARD MEASURE TABLE.

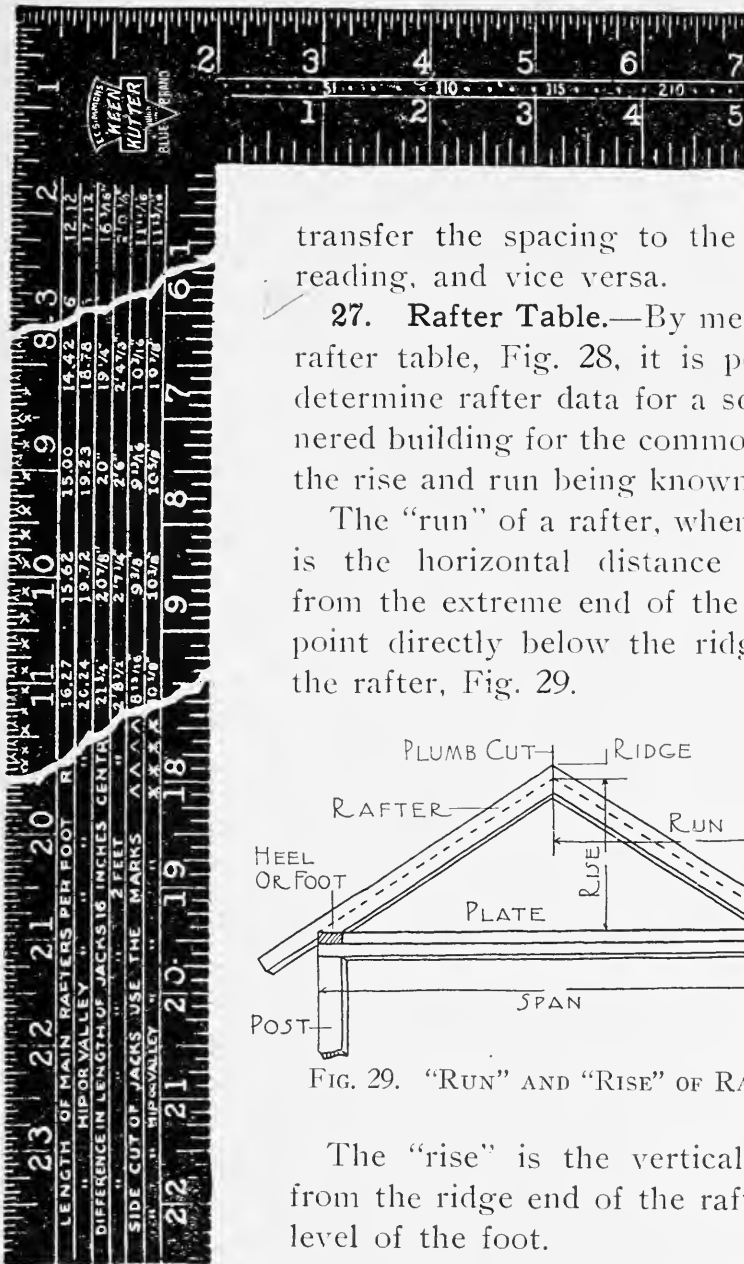

FIG. 28. NICHOLS' RAFTER TABLE.

transfer the spacing to the scale for reading, and vice versa.

27. **Rafter Table.**—By means of the rafter table, Fig. 28, it is possible to determine rafter data for a square cornered building for the common pitches, the rise and run being known.

The “run” of a rafter, when in place, is the horizontal distance measured from the extreme end of the foot to a point directly below the ridge end of the rafter, Fig. 29.

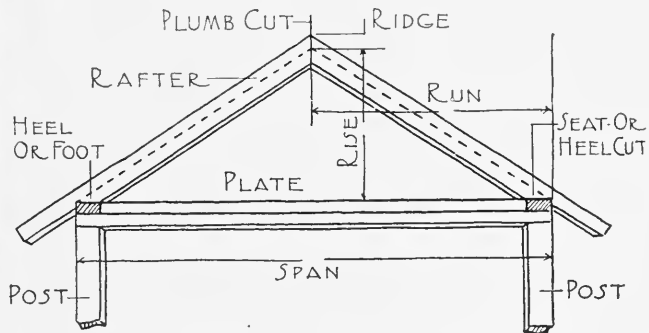

FIG. 29. “RUN” AND “RISE” OF RAFTERS.

The “rise” is the vertical distance from the ridge end of the rafter to the level of the foot.

The “pitch” of a rafter is the ratio of the rise of the rafter to the whole width of the building. Thus, if the span, Fig.

29, should be 24 ft. and the rise 8 ft., the pitch would be $\frac{1}{3}$.

The "cuts" of a rafter are obtained by placing the square so that the 12" mark on the blade and the number

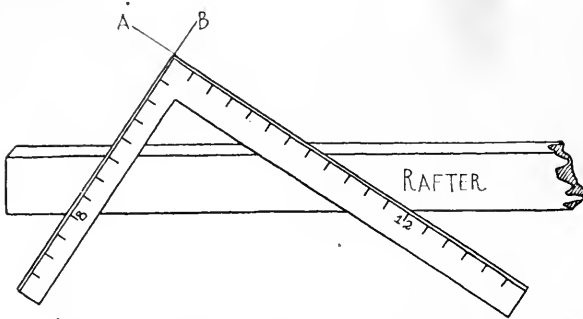

FIG. 30. SQUARE PLACED FOR PLUMB CUT.

on the tongue which represents the rise shall be on the edge of the rafter. In Fig. 30 the square is placed to give a cut on the end of the rafter suitable for an 8 ft. rise to a 24 ft. span, and 8" rise to a 12" run. The line B gives the angle for the ridge or plumb cut; the line A gives the cut for the foot of the rafter, the seat cut.

To make use of the table, Fig. 28, first look at the inch line figures on the outside, or top edge, of the blade for the figure that is the same as the rise of your roof. Under this figure will be found all the figures giving lengths of rafters and all side cuts. The run is 1 ft. on every table. There are seventeen of these tables, commencing at 2" and continuing to 18". For example, take 8" rise to the foot, or third pitch, under the 8" line figure. For length of common rafters, use the first figures in the table, 14.42", multiply by half the width of the building, which will give the whole length of the rafters. Suppose the width to be 20 ft., the rafters would be 144.20" long, or 12.01 ft.

For length of hip or valley rafter use the second figures, 18.78", and again multiply by half the width of the building, 10 ft., and the result, 15.65 ft., is the length required. For top and bottom cuts of rafters, common and "jacks," use the 8" and 12" marks on blade and tongue, either way as most convenient. (The 8" is the vertical, or top, of the

rafter, and the 12" is the horizontal, or bottom.) For hip and valley rafters, use 8" and 17", proceeding same as before.

For length of "jack" rafters, using third pitch as in previous example, the third number in the 8" table, $19\frac{1}{4}$ ", is the length of the first "jack" when they are spaced 16" between centers, and also the difference between the lengths of the others, each one $19\frac{1}{4}$ " longer than the one nearer the first one.

The fourth figure in the same 8" table, 2 ft. $4\frac{7}{8}$ ", is the length of the first "jack" rafter, 2 ft. between centers, also the difference in length of the others.

For side cut on "jacks," etc., the fifth figures in the table under the 8" mark are $10\frac{3}{16}$ ". These refer to the graduation marks on the outside edge of the blade. Put that $10\frac{3}{16}$ " mark on the edge of the "jack" and the 12" mark on the tongue on the same edge; mark the tongue for side cut of "jack." This also gives the right angle to cut plancier and mouldings on the jet that runs up the gable. The level plancier and moulding cuts, roof boards and shingles can be marked on the blade side of the square or the references transposed, using the 12" on the body and the body reference given in the table on the tongue.

Hip and valley rafter side cuts are marked by using the last figure in the table same as before.

Notice that the 12" mark on the tongue is always used in all angle cuts, both top and bottom and side cuts, thus leaving the workman but one number to remember when laying out side or angle cuts. This is the figure taken from the fifth or sixth number in the table. The cuts come always on the right hand or tongue side. When marking boards these can be reversed for convenience at any time by taking the 12" mark on the blade and using the blade reference on the tongue.

28. Determining Rafter Length by Scaling.—Counting the outer graduations on both tongue and blade of the

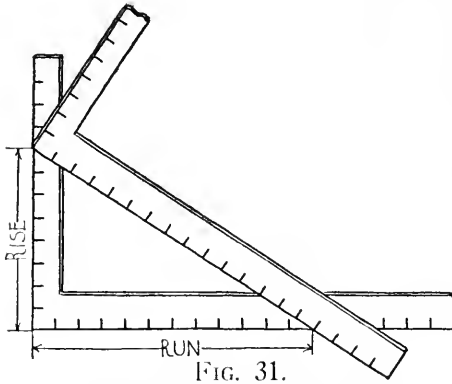

FIG. 31.
OBTAINING RAFTER LENGTH
BY SCALE METHOD.

back of the square, it will be seen that there are twelve to the inch. By considering the inch divisions as feet and the fractional divisions as inches, one can readily scale the length of a rafter by placing another square as shown in Fig. 31 and reading the graduations upon it as feet and inches.

A rule graduated to twelfths will serve in place of this second square.

29. Plumb and Level.—Fig. 32 is an illustration of a combined plumb and level. This instrument is used, as its name implies, to test for plumbness or levelness. The glasses are made and set with the crowning side up, thus

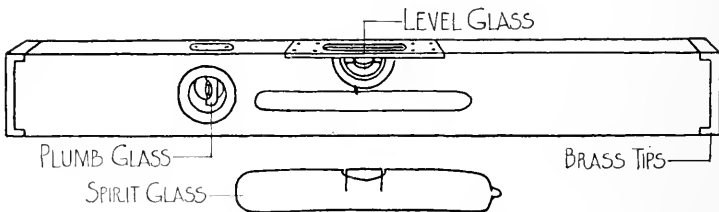

FIG. 32 . PLUMB AND LEVEL.

causing the bubble to seek the central part, which is marked by means of two indelible lines. In the best plumbs and levels this glass is adjustable, an outer plate being removed to give access to the adjusting screws. The usual length of this tool is from 24" to 30".

30. Mortise Gages.—Mortise gages differ from the marking gages in having two marking points or spurs so placed that they can be adjusted to mark the two sides of a mortise without change of position of spur. Fig. 33 is an illustration of a slide mortise gage, and Fig. 34 of a double bar mortise gage.

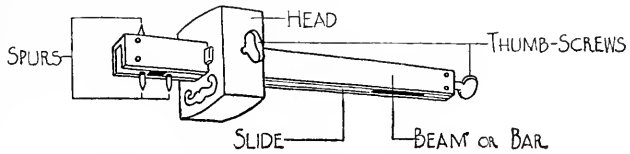

FIG. 33. MORTISE GAGE—SLIDE BAR.

In the slide mortise gage one point is fixed to the beam while the other point is attached to the end of a metal slide, on the reverse end of which is a thumbscrew. By adjusting this slide and the gage ahead, various settings are possible for mortises of various widths. To adjust, set the two spurs to the width of mortise desired, then adjust the head with reference to the nearer spur. If the mortise is to be cut by means of the chisel alone, the spurs may more safely be set by placing them to either side of the chisel edges.

In the double bar gage two independent slides work within one head. Each slide or bar has a fixed spur. One side of a mortise is marked and the gage rolled over to bring the spur of the other bar in contact. This gage is especially useful where two separate markings are to be made on different pieces of stock.

31. Butt Gage.—In hanging or hinging doors, where it is necessary to carry two and three different gage settings, the butt gage will be found convenient. It has its spurs so placed that lines may be gaged readily near or

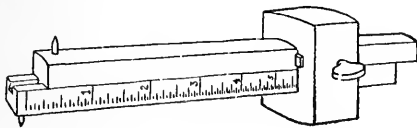

FIG. 34. MORTISE GAGE—
DOUBLE BAR.

into internal corners, a thing impossible with the ordinary gage with its spur placed back from the end of the slide or beam.

In hinging, two measurements are to be gaged—(1) the location of the hinge leaf on the jamb, with a corresponding location upon the door; (2) the location on both jamb and door for thickness of the leaf. Where several doors with similar hinges are to be hung, the butt gage carries the various settings without change and permits the spur to mark in the internal corners of stop and casing.

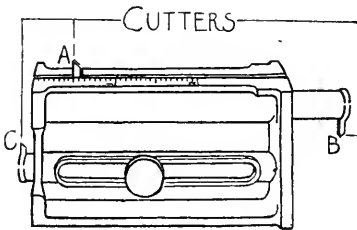

FIG. 35. BUTT GAGE.

Cutter A, Fig. 35, marks from the rabbet in the jamb; cutter B marks from the edge of the door engaged in closing; cutter C marks the thickness of the leaf of the hinge.

This gage may also be used as a square to square the location of the hinge on either door or jamb.

32. **Pattern-Maker's Gage; Gage Attachment.**—This gage, Fig. 36, has a roller cutter as well as a spur, so

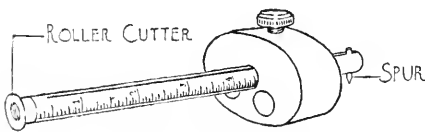

FIG. 36. PATTERN-MAKER'S GAGE.

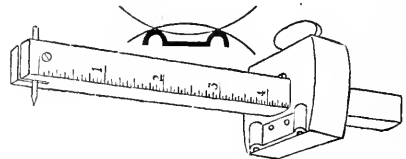

FIG. 37. GAGE ATTACHMENT.

placed that lines may be gaged up into internal corners.

Fig. 37 shows an attachment which makes possible the accurate marking from inside or outside curved edges.

33. Twist Drill Gage.

—The twist drill gage, Fig. 38, enables the worker to determine the drill number or gage for any particular piece of work.

34. Miter Square; Combination Square.—

This tool has its blade set at an angle of 45 degrees to the beam and is used in laying out miters of that number of degrees, Fig. 39.

The combination square with the bevel protractor will be found useful in pattern-making and in carpentry, as well as in machine shop work; and is fast supplanting the miter square. By means of it, Fig. 40, cylindrical pieces may be centered and angles of any number of degrees laid off.

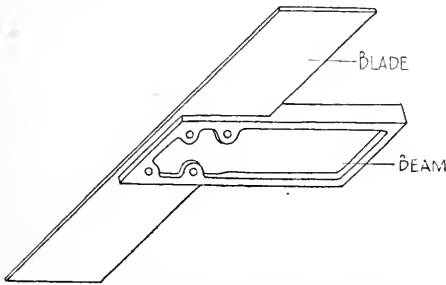

FIG. 39. MITER SQUARE.

**TIME O SAVER
DRILL & TAP DRILL GAGE
CHART
FOR MACHINE SCREW TAPS
THE L. S. STARRETT CO.
ATHOL, MASS., U. S. A.**

SIZE OF TAP	DRILL	DRILL	DECIMAL EQUIVALENTS
14X20	10	1/4	228
14X24	6	1/4	221
12X24	15	1	213
11X24	19	3	209
10X24	23	9	205
10X32	20	9	204
9X32	24	13	201
8X32	28	18	199
7X32	30	22	199
6X32	33	27	199
5X40	36	29	191
4X36	41	31	180
3X48	44	37	182
2X55	43	42	185

STEEL WIRE GAGE

FIG. 38. TWIST DRILL GAGE.

35. Spring Dividers.—

For pattern work where fine lines and great accuracy are required, spring dividers like those shown in Fig. 41 will be found useful.

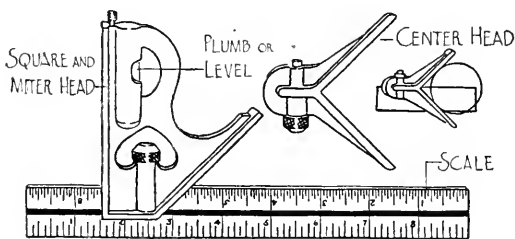
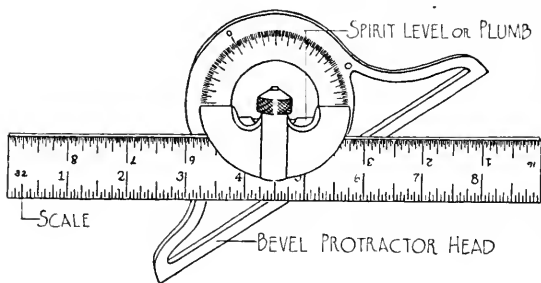

FIG. 40. BEVEL PROTRACTOR HEAD
COMBINATION SQUARE.

36. Calipers.—Calipers are of two kinds; inside, Fig. 42, and outside, Fig. 43. They are used in measuring or testing the diameters of cylindrical bodies, as in wood-turning. The adjusting nut may be either spring or solid. In the former the adjustment may be made very quickly, the action being not unlike that of the rapid-acting vise.

37. Trammel Points or Beam Compass.—Woodworkers frequently have occasion to strike arcs of circles requiring radii greater than can be secured with dividers. Trammel points, two scribers attached to a beam, Fig. 44, make possible such work. If desired, a pencil may be attached to one of the points.

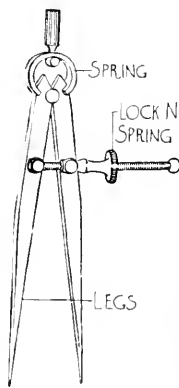

FIG. 41.
DIVIDERS.

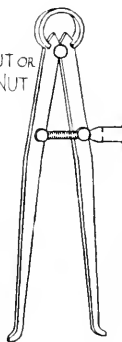

FIG. 42.
INSIDE
CALIPERS.

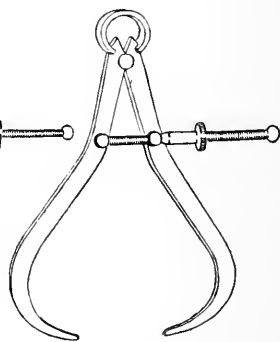

FIG. 43.
OUTSIDE
CALIPERS.

Trammel points may be got "large," length of points 2" with over-all length of $4\frac{3}{4}$ "; "medium" with length of points 2", over-all $4\frac{1}{4}$ "; "small" length of points $1\frac{1}{2}$ ", over-all length $3\frac{1}{2}$ ". Beams are not provided, unless so stated.

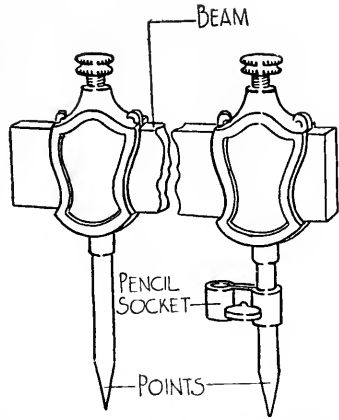

FIG. 44. TRAMMEL POINTS OR BEAM COMPASS.

38. Lumberman's Board Stick.

—This scale is made out of split hickory so that no cross grain may cause a weakness in it. In use, the metallic end is held against one edge of the board to be surveyed or estimated, the eye is fixed upon the figures on the metallic part and allowed to follow, to the other edge of the board, that division of the metallic part which represents the length of the board. It is seldom necessary for a surveyor to measure the length of a board, he learns to recognize standard lengths at a glance. That number of the division selected which is nearest the edge of the

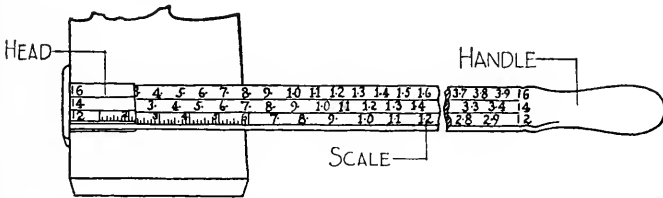
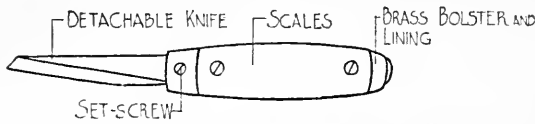

FIG. 45. LUMBERMAN'S BOARD STICK.

board gives the total number of board feet in a board 1" thick. Boards less than 1" are surveyed as 1". Boards thicker than 1" are surveyed as 1" and the total increased in proportion to the thickness above 1". Fig. 45.



39. **Pattern-Maker's Knife.**—A very convenient tool for pattern-makers is the knife shown in Fig. 46. It can



be fitted with a detachable handle and is suited to paring and laying out.

FIG. 46. PATTERN-MAKER'S KNIFE.

40. **Butt Chisel.**—The butt chisel, Fig. 47, is used mainly in trimming mortises and making gains for setting hardware, such as hinges.

Its short blade permits the worker to get closer to the work being done. The sizes, like those of other chisels, vary from $\frac{1}{8}$ " to 1" by eighths, and from 1" to 2" by quarters.

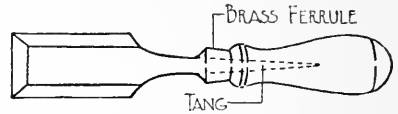

FIG. 47. BUTT CHISEL.

41. **Mortise Chisel.**—The mortise chisel, Fig. 48, has

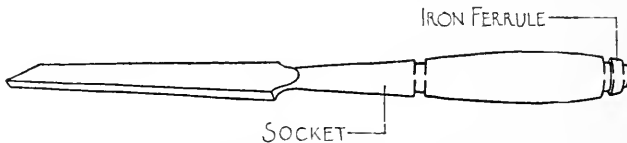

FIG. 48. MORTISE CHISEL.

an exceptionally heavy blade to withstand prying and heavy pounding.

42. **Corner Chisel.**—As its name implies, this chisel is used in cutting corners square after a series of holes

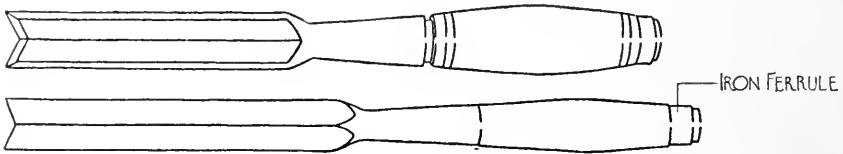

FIG. 49. CORNER CHISELS.

has been bored, for the mortise, Fig. 49. The sizes run from $\frac{3}{4}$ " to 1 $\frac{1}{4}$ " by eighths.

43. Wood-Turning Tools.—Wood-turning tools may be divided into two classes—those which cut the fibers and those which remove the surplus wood thru scraping. To the first class belong the turner's gouge and the turner's skew or chisel. The common tools belonging to this second class are the parting tool, straight tool, round-nose scraper, diamond-point parting tool, right and left skew scrapers, and inside scrapers. These are made in varying sizes.

44. Turner's Gouge.—This tool, Fig. 50, is used for roughing off. The bevel is on the outside and the corners are ground off as shown in the illustration. The cutting angle should be about 30° . Sizes vary from $\frac{1}{4}$ " to

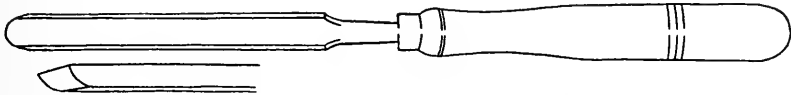

FIG. 50. LARGE TURNER'S GOUGE.

1" by eighths, and from 1" to 2" by quarters. The larger sizes are used for roughing off, while the smaller tools are used for concave cutting, the nose being slightly differently shaped as described later.

45. Skew or Turner's Chisel.—The skew, Fig. 51, is beveled on each side equally with a wedging angle of about 20° for soft wood and a side angle of about 70° .

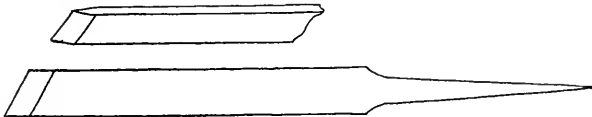
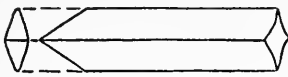

FIG. 51. TURNER'S SKEW CHISEL.

Smooth, safe work is possible only when turning tools are properly shaped and are given keen cutting edges. The skew, especially, should be well ground, oilstoned and honed. Sizes vary from $\frac{1}{8}$ " to 1" by eighths and from 1" to 2" by quarters.

46. Scraping Tools.—Scraping tools, Fig. 52, are ground on one side only, except the parting tool which



a. Cut-off, Diamond Point or Parting Tool.



b. Square Nose Scraping Chisel.

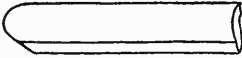

c. Round Nose Scraping Chisel.

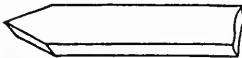

d. Spear or Diamond Point Scraper.

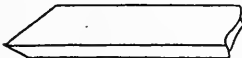

e. Left Skew Scraper.

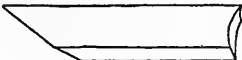

f. Right Skew Scraper.

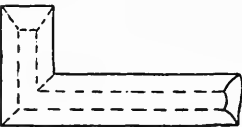

g. Inside Square Scraper.

FIG. 52. SCRAPING TOOLS.

is ground on two sides. Scraping tools are given wedges of about 45° .

Owing to the fact that these tools scrape instead of cut, like other scraping tools generally, they work best when given a scraping burr. After grinding and oilstoning in the usual manner, removing the wire edge, place the tool on the oilstone, Fig. 53, and move the tool as indicated. A firm but not heavy pressure is all that is required. The parting tool needs no burr.



FIG. 53. PUTTING BURR ON SCRAPING CHISEL.

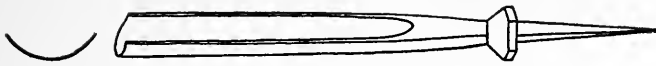

FIG. 54.
Straight Gouge.

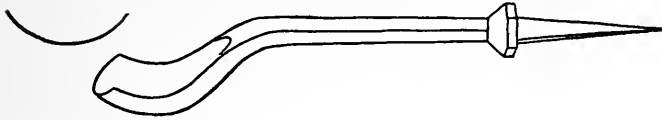

FIG. 55.
Short Bent
Gouge.

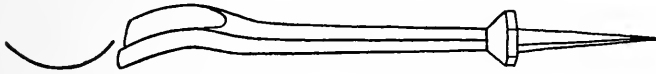

FIG. 56.
Back Short
Bent Gouge.



FIG. 57.
Long Bent
Gouge.

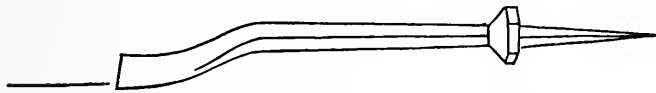

FIG. 58.
Front, Short
Bent Chisel.

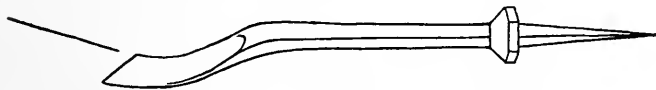

FIG. 59.
Right Corner
Chisel.

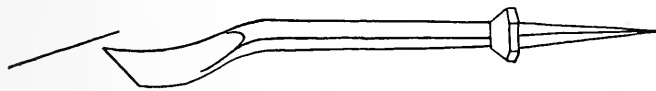

FIG. 60.
Left Corner
Chisel.

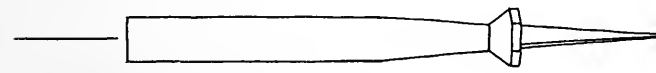

FIG. 61.
Carving or
Firmer Chisel.

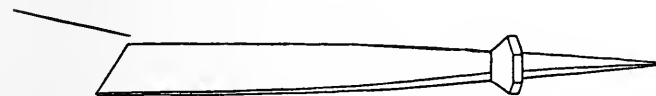

FIG. 62.
Skew Carving
or Corner
Firmer Chisel.

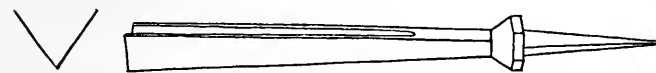

FIG. 63.
Parting Tools—
Straight, Short
Bent, Long
Bent.

47. Carving Tools.—Wood-carving tools vary in shape and size according to the particular use to which they are to be put. Among the most common forms are the straight gouge, Fig. 54; front, short bent gouge, Fig. 55; back, short bent gouge, Fig. 56; curved or long bent gouge, Fig. 57; front, short bent chisel, Fig. 58; right corner chisel, Fig. 59; left corner chisel, Fig. 60; carving or firmer chisel, Fig. 61; skew carving or corner firmer chisel, Fig. 62; long and short bent parting tools, Fig. 63.

Each of the gouges enumerated will vary not only in

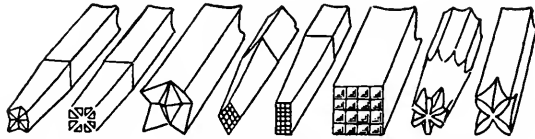

FIG. 64. CARVER'S MARKING PUNCHES.

size but in the amount of curvature as well. These curvatures or sweeps are known in general as quick, middle and flat. The internal angles of parting tools also vary. Common sizes run from $\frac{1}{8}$ " to $\frac{1}{2}$ " or $\frac{3}{4}$ " by eighths.

48. Carver's Punch.—These tools are used by carvers in giving a lowered background a treatment different from any possible with the other tools, Fig. 64.

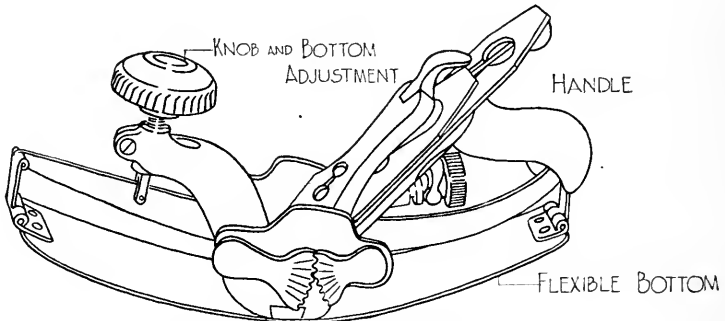

FIG. 65. CIRCULAR PLANE.

49. Circular Plane.—The circular plane, Fig. 65, is used for smoothing either convex or concave surfaces. By

means of an adjusting screw its bottom of flexible steel can be set to arcs of various curvatures. The tool is 10" long and carries a $1\frac{3}{4}$ " cutter.

50. Rabbet or Rebate Plane.—The rabbet plane, Fig. 66, is used in cutting rabbets or rebates. The plane shown in the illustration is fitted with a spur which scores the wood ahead of the cutter, thus insuring a clean corner. It also has an adjustable depth gage which prevents the plane from cutting deeper than is desired.

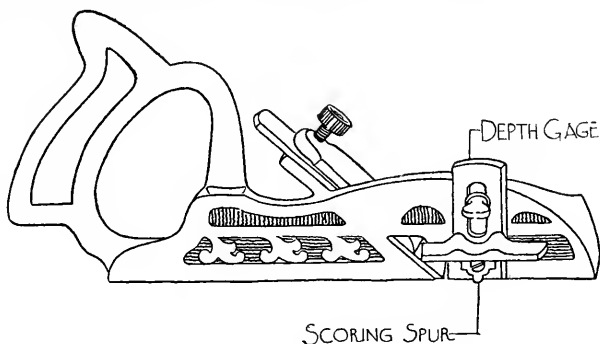

FIG. 66. RABBET OR REBATE PLANE.

In using this plane one must carefully press it against the guide, Fig. 67. In one's effort to do this the plane is sometimes tilted from level; this but serves to aggravate the difficulty. When this happens it is best to stop planing and straighten up the vertical side of the rabbet by means of a paring chisel, then proceed.

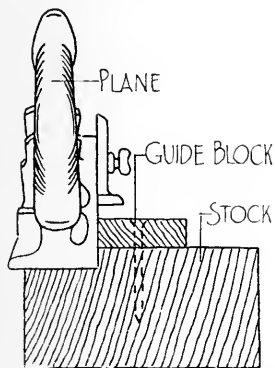

FIG. 67. GUIDE FOR RABBET PLANE.

In rabbeting on the reverse side of stock, small brads are used to fasten a guide or fence against which the plane is to be placed in beginning the rabbet. Where the rabbet is to be cut on a face, a broader guide

must be used and hand clamps attached to hold it in place.

The length of this plane is 8" and the cutters are 1", $1\frac{1}{4}$ " and $1\frac{1}{2}$ " wide.

51. Rabbet and Filletster Plane.—In Fig. 68 is shown such a plane with two seats for the cutter. The forward

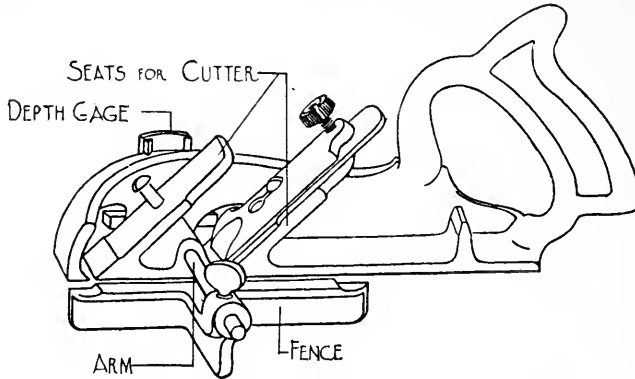

FIG. 68. RABBET AND FILLETSTER PLANE.

seat is used where it is desired to plane up into a corner. This plane differs from the rabbet plane just described in having an adjustable fence or guide attached to the stock

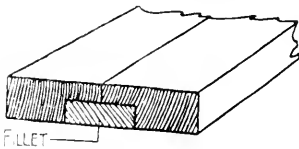

FIG. 69.

FILLETSTERED JOINT.

of the plane. This guide obviates the necessity for tacking a guide to the wood being planed or of using hand clamps to hold such a guide in place. It can be attached to either the right or left side of the stock. Fig. 69 illustrates a filletstered joint. The length of plane is $8\frac{1}{2}$ " with a cutter $1\frac{1}{2}$ " wide.

52. Dado Plane.—The dado plane is made in various widths and is used to cut dados, or grooves, across the grain of the wood. The plane shown in Fig. 70 has two cutting spurs one on each side of the plane to precede the cutter and score the wood that it may be removed without breaking. The cutter is set on askew. The plane is guided by means of a strip, or fence, fastened to the stock being planed, Fig. 71. The usual length of plane is 8" and the cutters and widths of plane vary from $\frac{1}{4}$ " to 1" by eighths.

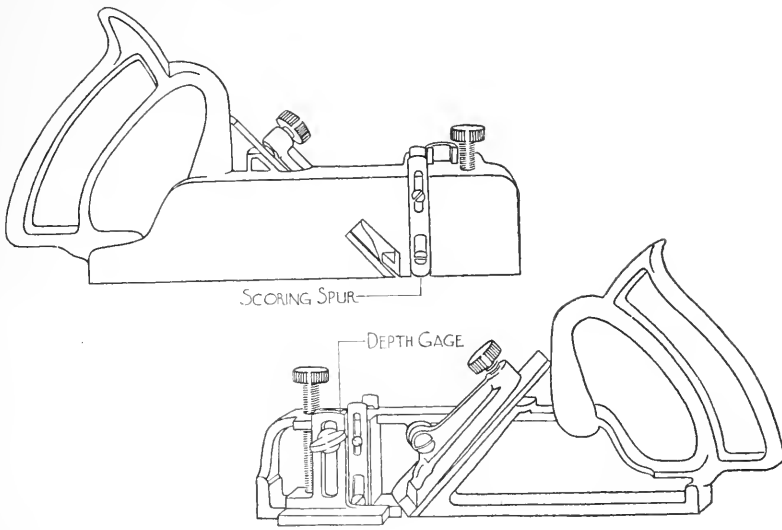

FIG. 70. DADO PLANE.

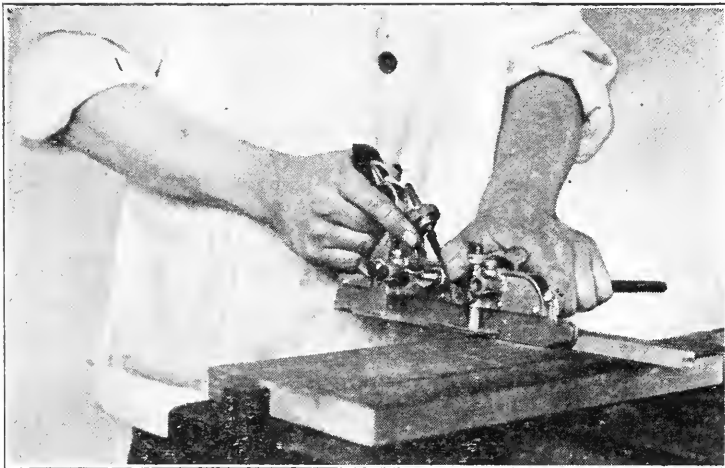

FIG. 71. PLANING DADO JOINT.

53. Plow and Matching Plane.—The plow is used to cut grooves along the grain. By an exchange of cutters various sized grooves may be worked. An adjustable

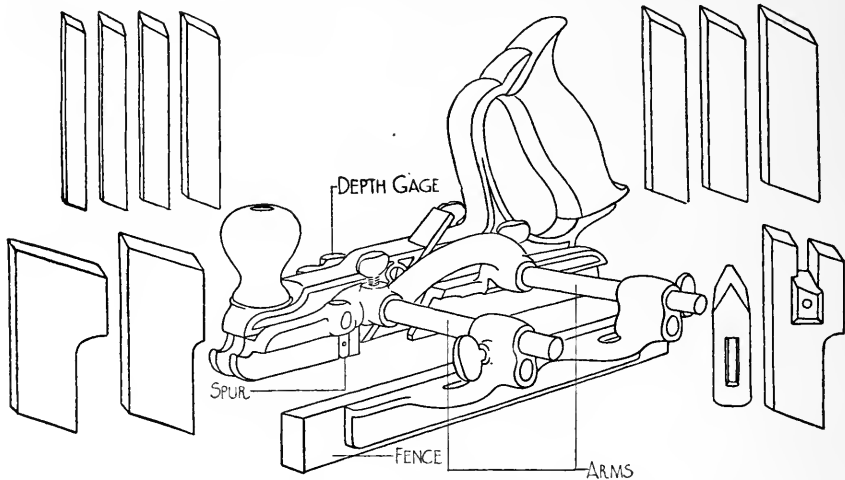

FIG. 72. PLOW AND MATCHING PLANE.

fence determines the distance of the groove from the edge of the board while a depth gage limits the depth. The plane shown in Fig. 72 is a combination plane which may be used as a plow, dado, filletster, and matching plane. The length is $10\frac{1}{2}$ ".



FIG. 72A.

MATCHED JOINT.

Plow and dado bits range in size from $\frac{3}{16}$ " to $\frac{3}{8}$ " by sixteenths, with $\frac{1}{2}$ ", $\frac{5}{8}$ ", $\frac{7}{8}$ ", 1", and $1\frac{1}{4}$ " additional; also there is a $1\frac{1}{2}$ " filletster cutter and a $\frac{1}{4}$ " tonguing and slitting tool.

54. Universal Plane.—Fig. 73 illustrates a plane which, by a proper selection of cutters, can be made to do the work of a (1) beader, center beader; (2) rabbet and filletster; (3) dado; (4) plow; (5) matching plane; (6) slitting plane; (7) sash plane; (8) molding plane. Varying sizes for each kind of cutter make possible an

unlimited variety. The plane is possessed of a fence, stop, or depth gage, and of adjustable cutting or scoring spurs when working across the grain.

The main stock, A, carries the cutter adjustment and a steel bottom which form a bearing for the outer edge

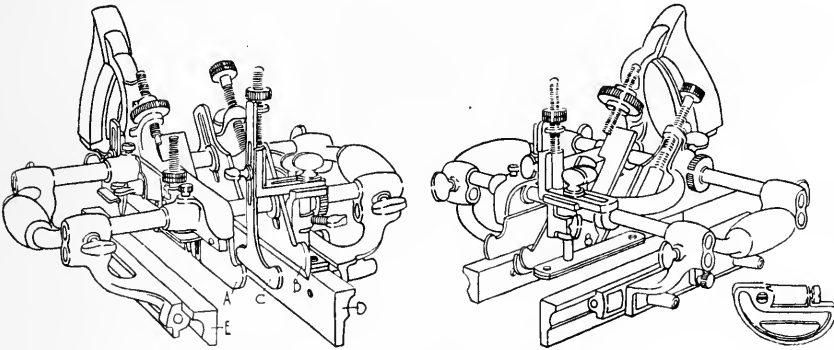

FIG. 73. UNIVERSAL PLANE.

of the cutter which slides on arms secured to the main stock. This bottom can be raised or lowered so that cutters can be used having one edge higher or lower than the edge supported in the main stock, in addition to allowing the use of cutters of different widths.

An extra support or stop is necessary for cutters which first enter the wood at a point between the outside edges. This is also of service when using cutters which, if the plane were unintentionally tilted, would tend to gouge the work. The auxiliary bottom, C, capable of adjustment for width and depth, serves this purpose.

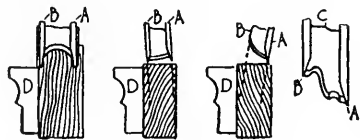

FIG. 74.
ANGLES FOR SETTING
FENCE, UNIVERSAL PLANE.

The fence, D, has a lateral screw adjustment for fine setting. The fences can be used on either side of the plane and the wood guides can be tilted to any angle up

to 45°. Fence E can be reversed for center beading wide boards.

In working at a distance from the edge of a board, the tendency of the fence to sag is overcome by attaching the cam rest shown beside the plane in Fig. 73 to the front arm. On certain kinds of work it is attached to the

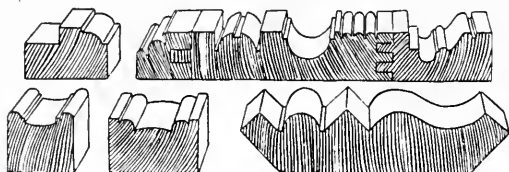

FIG. 75.

WORD DONE BY UNIVERSAL PLANE.

rear arm to assist in preventing the plane from rocking. This is of great importance.

Fig. 75 shows some of the forms which may be worked with this plane.

55. Router Plane.—A very convenient tool for smoothing the bottoms of dados and enclosed grooves across the grain is the router plane, Fig. 76. This plane has two cutters, $\frac{1}{2}$ " and $\frac{1}{4}$ " respectively. It also has an attachment for regulating the thickness of the shaving and closing the throat on narrow work. When cutting into corners the cutter is reversed on the post.

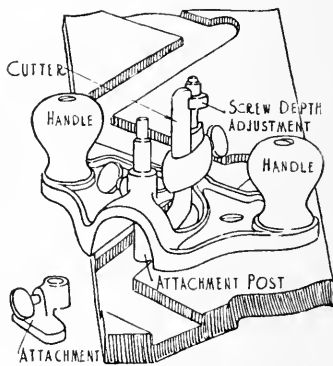

FIG. 76. ROUTER PLANE.

56. Scraper Plane.—Scraper planes are made in a variety of forms. Fig. 77 shows a common form. The angle at which the scraper steel shall rest with reference to the work is determined by the horizontal adjusting screw and nuts. Cutters are $2\frac{1}{2}$ " or 3" in width and the plane

length is 9". This tool can be used as a tothing plane by inserting the tothing cutter shown in the illustration. Tothing cutters are used to rough the surface of the wood preparatory to laying veneer. It is also used to scrape off old glue and paint. Scraping cutters have 22, 28 or 32 teeth to the inch.

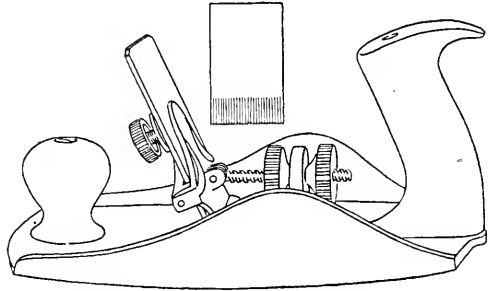

FIG. 77. SCRAPER PLANE.

57. Handled Scraper.—Among the various forms of holding tools for scraper steels or blades is the one shown in Fig. 78. By means of a set screw the blade may be given a curvature similar to that obtained when the scraper is held in the hands. The handles are 11" long and carry a 2 $\frac{3}{4}$ " blade.

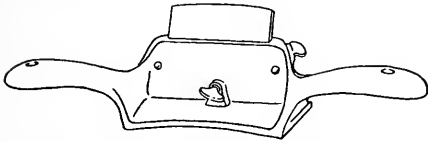

FIG. 78. HANDLED CABINET SCRAPER.

58. Veneer Scraper.—The veneer scraper, Fig. 79, is similar in principle and operation and use to the scrapers just described. It can be obtained in two lengths, 6 $\frac{1}{4}$ " and 9 $\frac{1}{2}$ " with 2" and 3" blades.

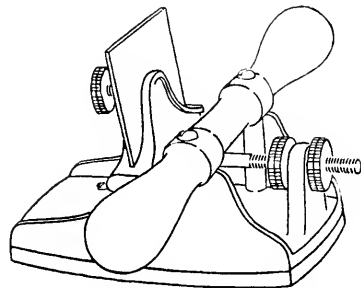

FIG. 79. VENEER SCRAPER.

59. Core-Box Plane.—The core-box plane, Fig. 80, is used by pattern-makers in forming the hollows of cylindrical core-boxes. The sides of the plane are at right angles one to the other. The blade projects below the lower arris and can be set so as to cut from either side. The plane works upon the principle that only a right

angle may be inscribed in a semicircle. From this it follows that, if the sides or sections of this plane rest upon

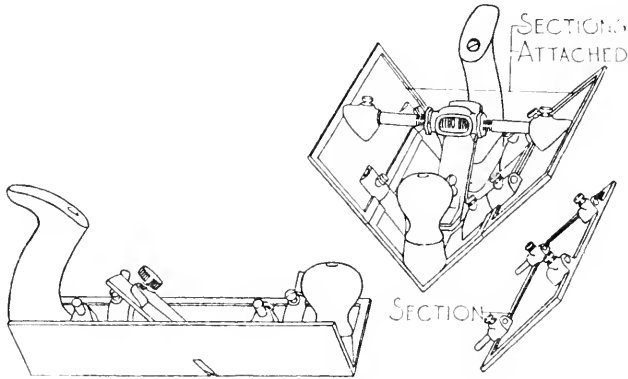

FIG. 80. CORE-BOX PLANE.

the edges of the cut, the cutter must describe a semi-circular section.

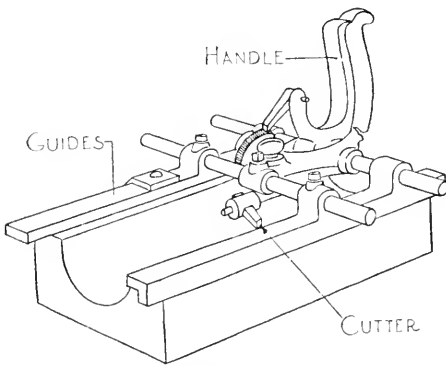

FIG. 81.

NEW STYLE CORE-BOX PLANE.

Without the additional sections this plane will form boxes with diameters of 1" to 2½". Additional sections can be secured which make possible core boxes with sections up to 10" in diameter, each pair adding 2½" to the diameter. Tapering core-boxes

can be formed with this plane.

Fig. 81 is an illustration of a core-box plane in which the cutter revolves in a semicircular arc while the plane itself moves in a horizontal direction with reference to the stock. The manner of using these planes is described in the chapter on Pattern Making.

60. Drawing-Knife.—The drawing-knife or draw-shave is used to take off quantities of wood too great to be planed and too slight to be worth saving by sawing. It is also used in curved work. It is beveled on one edge only, Fig. 82.

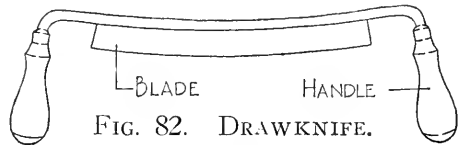

FIG. 82. DRAWKNIFE.

The length is determined by the length of the blade and varies from 6" to 14" by even inches.

61. Expansion Bit.—The expansion bit, Fig. 83, is made with an adjustable cutter which makes possible the boring of holes of various sizes with the same bit.

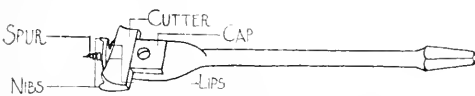

FIG. 83. EXPANSION BIT.

A still greater range is made possible by the use of other cutters of greater reach. For

small bits, one cutter will give a range of $\frac{5}{8}$ " to $1\frac{1}{8}$ ". A second cutter gives $1\frac{1}{8}$ " to $1\frac{3}{4}$ ". Cutters for large bits give a range of $\frac{7}{8}$ " to $1\frac{5}{8}$ ", $1\frac{5}{8}$ " to 3", and 3" to 4".

62. Nut Augers.—Where greater depths are to be bored than can be bored with bits of ordinary length of shank, special forms are necessary. Again, where large holes are to be bored in hard wood it is difficult to accomplish the result with an extension bit, be-

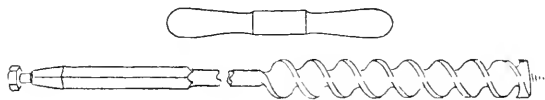

FIG. 84. NUT AUGER.

cause of the small leverage and the fact that only one hand is available for turning the crank. Fig. 84 is an illustration of a bit especially constructed for this purpose. The sizes run from $\frac{1}{2}$ " to 1" by eighths, and from 1" to 3" by quarters. The screws are coarse, thus making for fast boring.

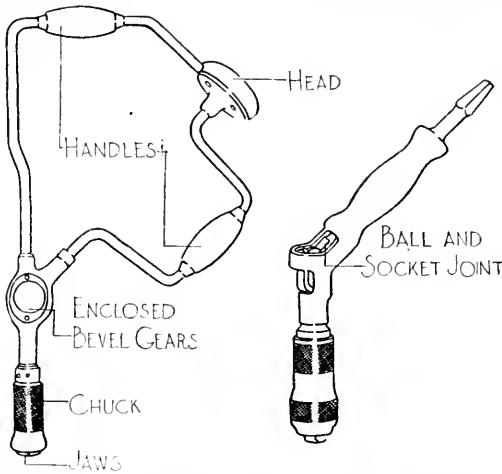

FIG. 85. BEVELED GEAR CORNER BRACE AND ANGULAR BORING ATTACHMENT.

63. Angular Boring Attachment. — Special braces called "corner braces" are made for the boring of holes alongside walls and in corners.

Fig. 85, shows an attachment for an ordinary brace to be used for such purposes, also a bevel geared corner brace.

64. Bit Extension.—This attachment, which can be obtained in lengths from 12" to 30", will be found necessary in many places in cabinet work. Fig. 86.

65. Breast Drill.—The breast drill shown in Fig. 87 is what is known as double speed. By shifting the position of the handle an even speed, or one to one, is obtained.

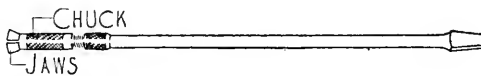

FIG. 86. EXTENSION BIT HOLDER.

This is the speed to be used with the larger sized drills. The first speed is used with small drills and has a ratio of three to one.

A level is attached to the frame to assist the worker in maintaining a horizontal position while boring. The spindle is kept from turning while changing drills by means of a latch mounted on the frame. Different sweeps of the crank are obtained by shifting the crank handle

into one or another of the three holes in the crank-arm. These drills may be secured with a universal chuck which will grip either a taper or a round shank.

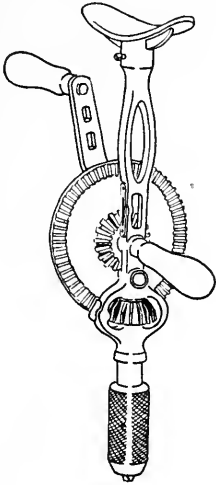

FIG. 87.
BREAST DRILL.



FIG. 88.
HAND DRILL.

66. Hand-Drill.—The hand-drill is used for the rapid drilling of small holes. The one shown in Fig. 88 has a removable top, the hollow handle containing an assortment of small drills of various sizes.

67. Automatic Hand-Drill.—This tool, Fig. 89, is but another form of hand-drill. It is more generally used by carpenters than the one just described. The hand-drill with the gear is used more frequently by metal-workers. The automatic hand-drill is constructed

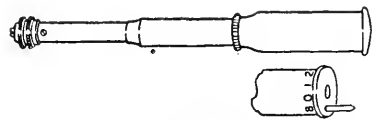

FIG. 89. AUTOMATIC DRILL.

so that the drill will revolve rapidly upon the application of a downward pressure on the head. The handle contains compartments with the following sized drills: $11/64''$, $5/32''$, $9/64''$, $1/8''$, $7/64''$, $3/32''$, $5/64''$, $1/16''$.

68. Spiral Screwdriver.—The spiral screwdriver, like the automatic hand-drill, is made to revolve rapidly upon pressure being exerted on the head or handle. Its

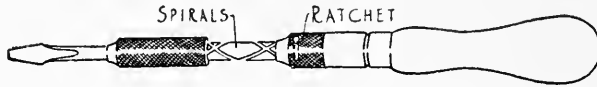

FIG. 90. SPIRAL SCREWDRIVER.

advantage lies in the rapidity with which it works. Fig. 90. The spirals should be kept well lubricated.

Ratchet screwdrivers, while not so rapid in their action, are useful and are preferred to the common screwdriver by mechanics.

69. Awls.—Patent awls are in quite common use. Fig. 91 illustrates one type, with the various points which belong to it.

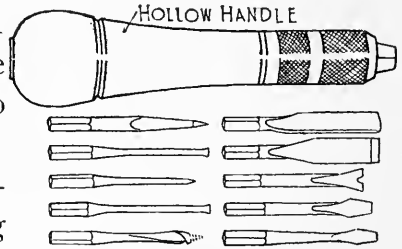

FIG. 91. PATENT AWL.

The brad awl point is wedge-shaped, and is used for making small holes, as for tacks or brads and small screws. The

scratch, or scribe, awl is pointed and is used mainly for locating centers and for scribing or marking on heavy bridge or barn timbers where a pencil line would not show easily.

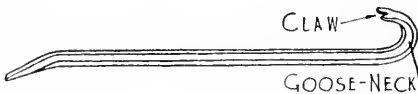

FIG. 92. WRECKING BAR.

70. Wrecking Bar.—The wrecking bar, Fig. 92, is a most effective tool for dismantling wooden frames.

71. Nail Puller.—The nail puller, Fig. 93, is used to withdraw nails whose heads have been sunk even with or below the surface of the wood. A heavy head which is free to be moved up and down on the vertical stem is

used to force the jaws into the wood on either side of the nail head, after which the jaws are closed and the nail withdrawn by inclining the head to one side, the pro-

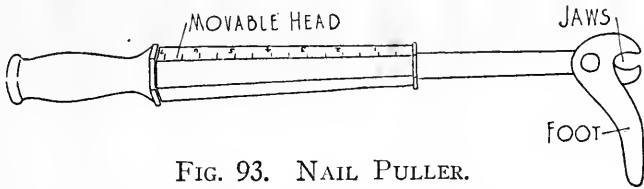

FIG. 93. NAIL PULLER.

jecting foot being used as a fulcrum. The wood is marred, of course, so that the tool can be used only upon coarse work, as in opening boxes and on rough carpentry.

72. Glass Cutter.—The glass cutter can hardly be classed as a woodworker's tool but is included here because manual training shops frequently make use of it on small jobs of glass setting. The cutter shown in Fig. 94 has a carbonized steel wheel. A straight-edge is held firmly upon the glass to be cut and this cutter is drawn along it with firm, even pressure sufficient to score the

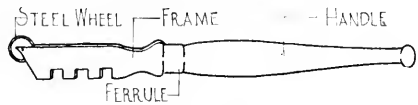

FIG. 94. GLASS CUTTER.

surface of the glass so that it will break when bending pressure is applied with the hands to the two parts. The grooves or notches in the tool serve as jaws to break away any particles which fail to break along the desired line.

73. Files and Rasps.—In as much as there are some three thousand varieties of files, little more can be done here than to indicate the most common characteristics.

Files differ from rasps in that the former have serrations extending obliquely across the tool while in the case of rasps the cutting edges are triangular points which project from the body of the tool. In either case the cutting edges are formed while the tool is hot.

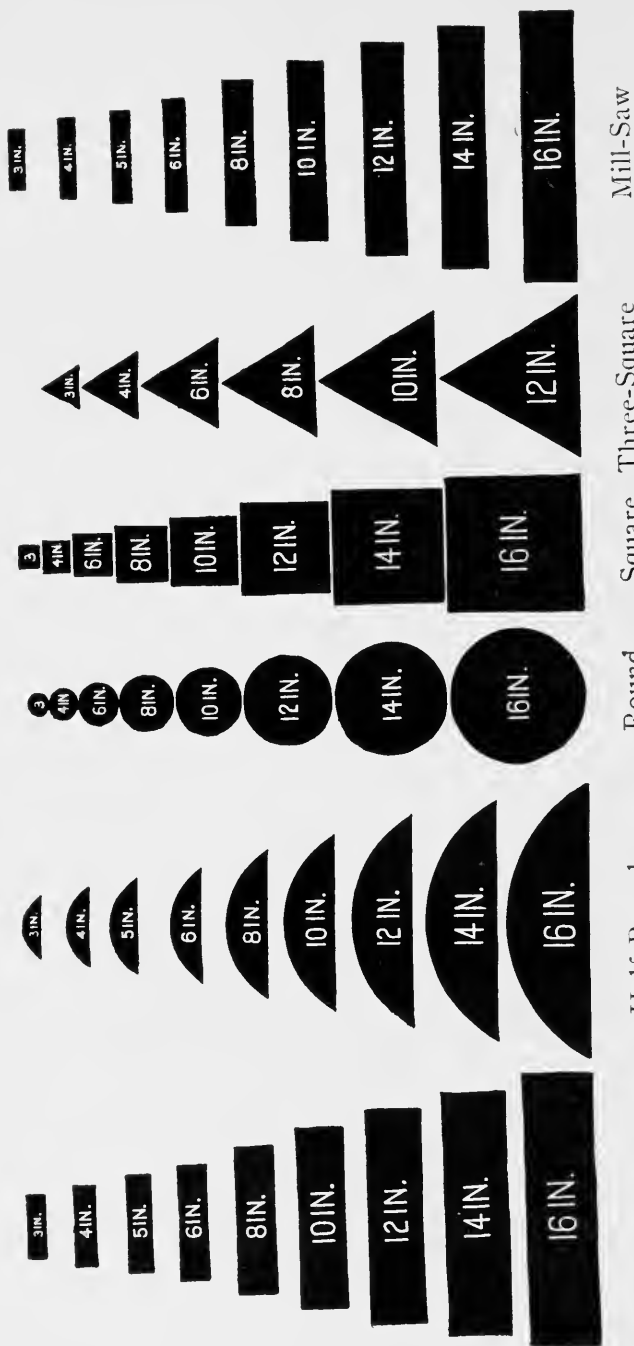

FIG. 95. SECTIONS OF FILES THREE-FOURTHS SIZE.

A good working principle to follow in the use of wood files is: Use files and rasps only where edged tools cannot be used to advantage. Rasps and wood files are legitimate tools, but their use on the part of beginners is often unwarranted.

When filing, pressure should be placed upon the tool only when it is on the forward stroke. To place it otherwise is to break the fine cutting edges which are buttressed on the forward stroke but not on the backward.

Files, in general, are distinguished by their (1) length, (2) kind or name, (3) and their cut.

Length is always measured exclusive of the tang. Length bears no fixed relation to either the width or thickness, even of the same kind of file.

By kind of file is meant the various shapes and styles. Fig. 95 shows cross-sections of various kinds. Not only do files vary in cross-section but in general contour or shape as well, as taper and blunt, Fig. 96. Taper files are such as have the cross-section reduced in width and thickness as it approaches the point. The three-square handsaw file is often designated simply as a taper file. A blunt file is one which preserves the same size of section from tang to point.

As to cut, files are divided according to the character of the teeth into single, double, and rasp cut, Fig. 97. In single cut the serrations extend obliquely in one direction only. In double cut, the single cuts are crossed by a set of opposite oblique serrations. The rasp is made by triangular indentations in the steel while soft.

The cut also varies according to the fineness or coarseness of the serrations. There will be rough, coarse, bastard, second cut, smooth, and dead smooth, Fig. 97. Coarse and bastard cuts are used upon heavy, rough work.

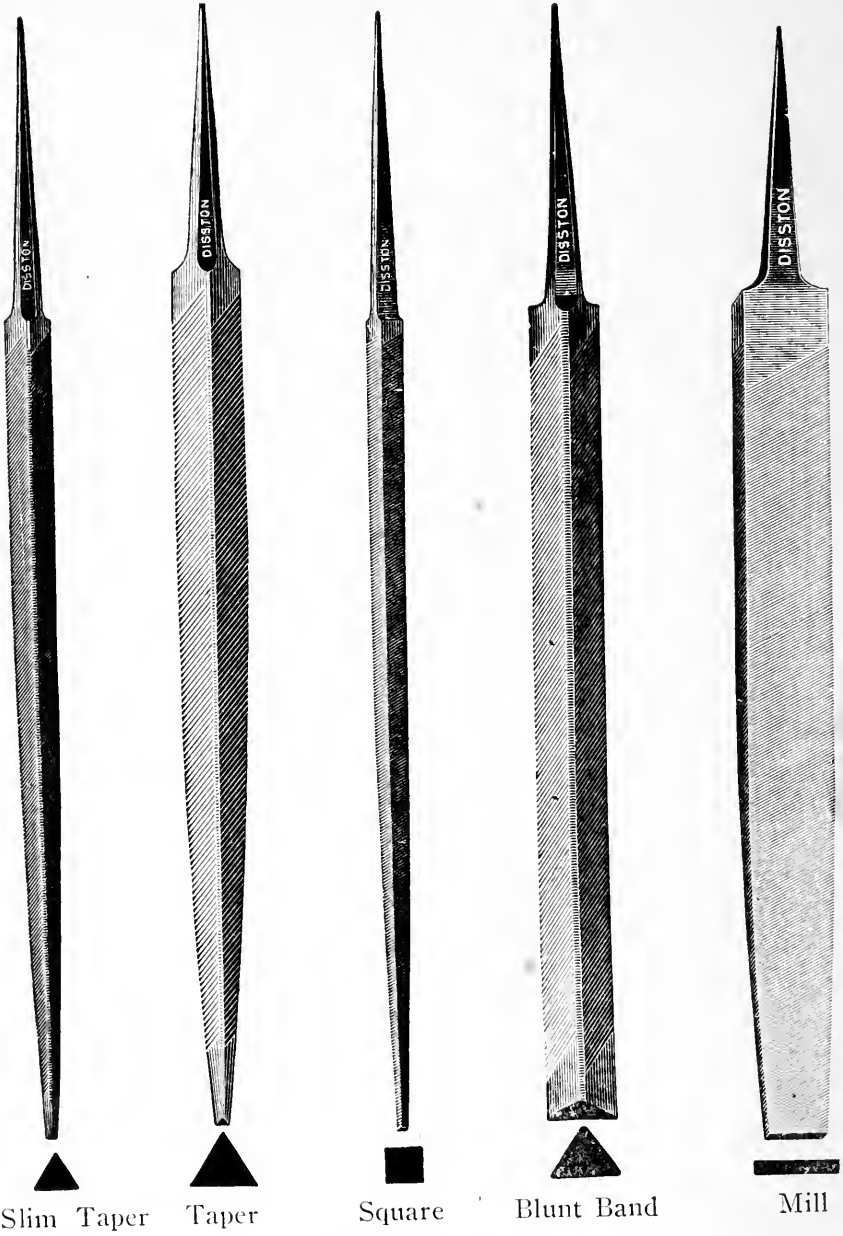
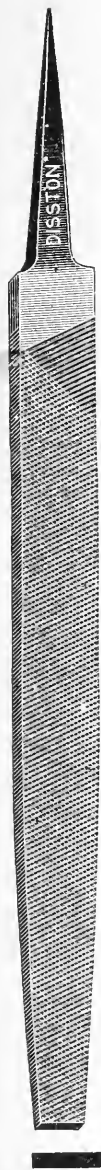
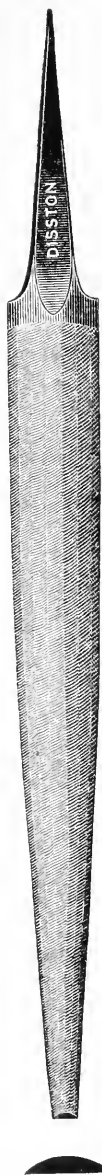

FIG. 96. FILES.



Flat Bastard



Half-Round



Round



Half-Round
Wood Rasp

Second cut and smooth are used upon finer work. Rough and dead smooth are seldom used. Superfine or supercut are terms used by Lancashire file-makers to designate dead smooth.

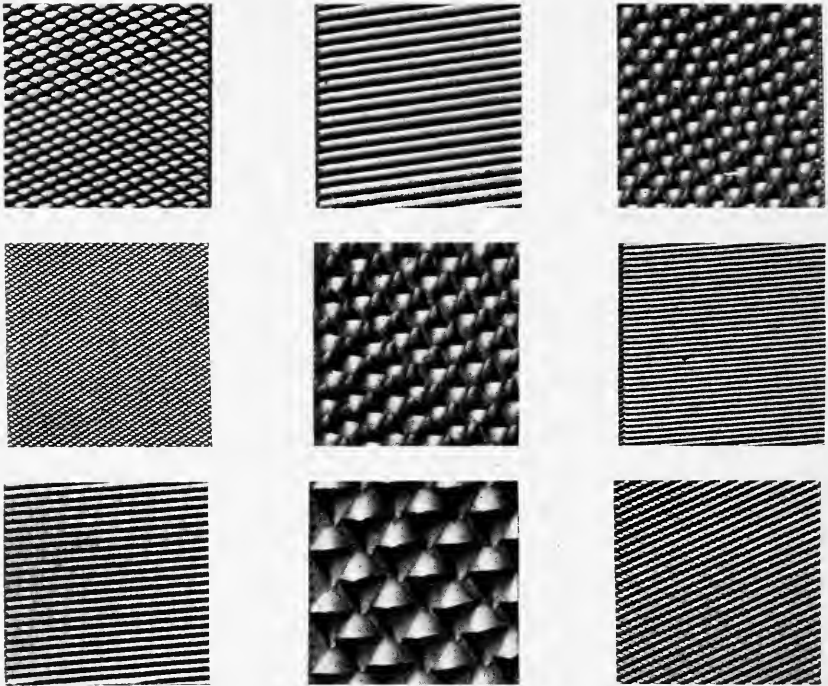

FIG. 97. THE CUTS OF FILES.

Among the many special forms of files is the auger-bit file, Fig. 98. One end has serrations on the two edges

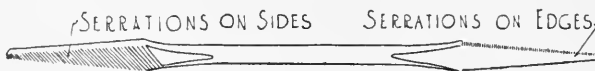

FIG. 98. AUGER BIT FILE.

only, the other end has serrations on the two surfaces only. This is done so that the nibs may be protected when filing the lips, and vice versa.

74. File Cleaner.—The file cleaner, Fig. 99, is used to brush filings from the serrations. One side has stiff bristles and the other wire.

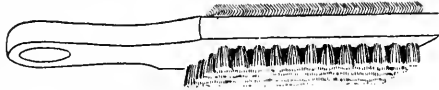

FIG. 99. FILE CLEANER.

75. Belt Punch.—Fig. 100 illustrates one form of belt punch. By revolving the cylinder four sizes of holes may be cut.

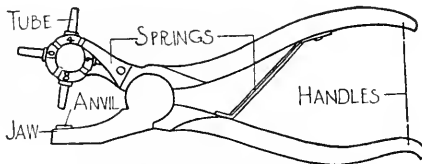

FIG. 100. BELT PUNCH.

76. Plug Cutter.—The plug cutter, Fig. 101, is used to cut plugs to fit over the heads of flat-head screws in furniture fastenings.

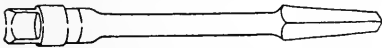

FIG. 101. PLUG CUTTER.

77. Screw and Plug Bit.—This tool, Fig. 102, is used to prepare a hole where a screw head is to be sunk



FIG. 102. SCREW AND PLUG BIT.

below a surface and afterward covered with a wooden plug.

78. Washer Cutter.—The washer cutter, Fig. 103, has adjustable cutters. The tool is used in connection with a brace.

79. Emery Wheel Dresser.—With the rapid introduction of electrically fused abrasive grinding wheels in the place of grindstones in the wood shop has come the need

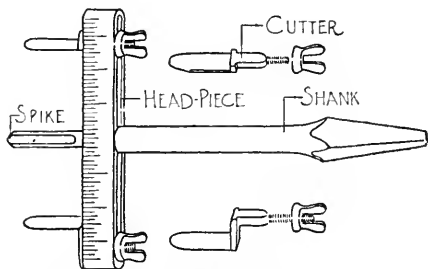

FIG. 103. WASHER CUTTER.

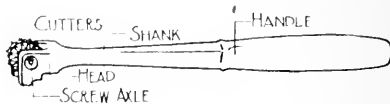

FIG. 104.

EMERY WHEEL DRESSER.

for a dresser. This tool, Fig. 104, has especially hardened steel cutters which, when properly held, will cut away the high places on the grinding wheel.

80. Sharpening Auger Bits.—An auger bit is easily sharpened; it is as easily spoiled by improper sharpening. Hold the bit as in Fig. 105. File the inside surfaces of



FIG. 105.

SHARPENING AN AUGER BIT.

the nibs and the under surfaces of the lips.

The most common mistake beginners make, and a most serious one, is to file the nibs on the outer surfaces. A little consideration will indicate that to so file a bit is to make the cutting nibs begin a hole the diameter of which is less than that of the twist, with the result that the twist allows the cutters of the lips to proceed only a short distance into the wood when a wedging action inhibits further cutting.

In filing the under sides of the lips care must be taken to get good clearance, remembering that the lips are proceeding downward at a fairly rapid rate. If sufficient clearance is not given the back edge of the lips, that part nearest and growing into the twist keeps the lips from cutting properly.

81. Forstner Auger Bit.—This bit, Fig. 106, has special advantages over the ordinary auger-bit on certain kinds of work. It has no spur but depends upon an outer rim for centering. It is claimed that, on account of this,

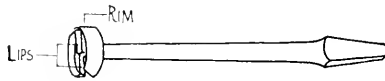

FIG. 106. FORSTNER BIT.

knots, cracks, and change of direction in the grain of the wood will not affect the boring direction; that it will not split the wood however close the hole may be to an edge; that by means of this rim a hole may be bored where a smaller hole has already been bored; and that oval, oblong, or square holes may be made of a hole already bored.

To sharpen this bit, take a three cornered file and grind its point, not tang, to form a three cornered scraper. Scrape the inside of the flange of the cutting rim until

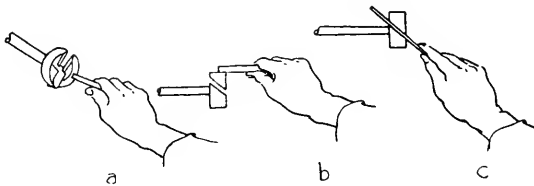

FIG. 107. SHARPENING FORSTNER BIT.

it is sharp. Use an oil stone to remove the wire edge formed on the outside, Fig. 107, a and b. For very smooth work see that the flange is drawn beyond the cutters well and then oilstone a bevel with clearance.

Sometimes a bit will be too hard to scrape and file. In such a case a pair of tongs, such as are used in brazing band-saws, may be heated and the shank held close to the flange. The temper is drawn to a light blue color when the bit is to be dipped into water.

The cutters are filed with a small fine file as in Fig. 107, c.

82. Sharpening Saws.—There is but one way to learn to sharpen a saw, and that is to make an attempt and persevere until the result is accomplished and the habit fixed.

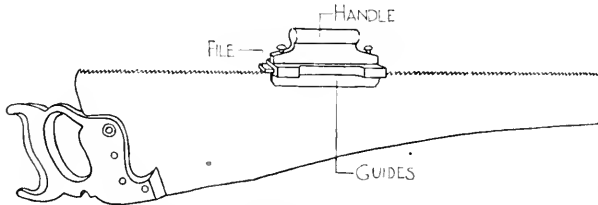

FIG. 108. TOP JOINTING A SAW.

The habits involved are rather complex and most beginners do not succeed as readily as in learning some of the other processes. Like every other habit, however, when once fixed it becomes second nature.

The first thing is to note whether the teeth project evenly or not. If some project farther than others it will be necessary to top-joint them. This is accomplished by a tool known as a saw jointer, Fig. 108. This tool consists of a short, flat file and a holder which keeps the file at right angles to the blade of the saw.

It is not necessary to top-joint a saw every time it is filed. Frequently a saw needs merely "touching up," filing only.

One or two light runs the full length of the saw should be sufficient to joint the teeth to the same projection, ordinarily. If more than two runs are needed, it is better to file the teeth after the first two jointings and then joint again and file. A saw in very bad condition may require as many as three filings with intervening jointings of two top runs each.

In jointing a hand or rip-saw, try to joint so as to produce a crown in the length of the saw of about one-eighth of an inch.

The second step consists in setting the teeth. Not uncommonly the teeth are set before the top-jointing is done. The advantages and disadvantages are about equal in either case.

The most common saw-set in use today is the hand set. Fig. 109. An adjustable anvil makes possible the

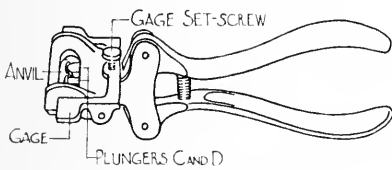

FIG. 109. SAW SET.

setting of saws with small or large teeth to any desired amount. A good rule to remember in saw-setting is: Give the teeth no more set than is absolutely necessary

for them to do the work required of them. Too much set makes waste in stock, rough kerfs, unnecessary muscular exertion, and difficulty in controlling the saw, to say nothing of the danger of breaking off the teeth in setting, especially if the saw is hard tempered. Panel saws, tenon saws, and dovetail saws are not, as a rule, set at all, the taper of the blade from the toothed edge toward the back giving sufficient clearance. Another point to be guarded is to see that the anvil is so adjusted that the point of the tooth receives the bend rather than the whole tooth. If the whole tooth is bent there is danger of breaks in the blade at the roots of the teeth. Begin

at one end of the saw and set every other tooth, then reverse and work the remaining teeth from the opposite side. Fig. 110.

The third step consists in filing the teeth to the proper angle and size. Place the saw in the saw vise, Fig. 111. Assume an easy position so that, as the filing proceeds, the same angle may be maintained. File every other tooth, filing those with the set pointing away from you. Reverse the saw and file the remaining teeth. Release the filing pressure on the backward stroke. It is a good practice to go over the saw once with a uniform pressure, taking the same number of strokes to



FIG. 110. SETTING SAW TEETH.

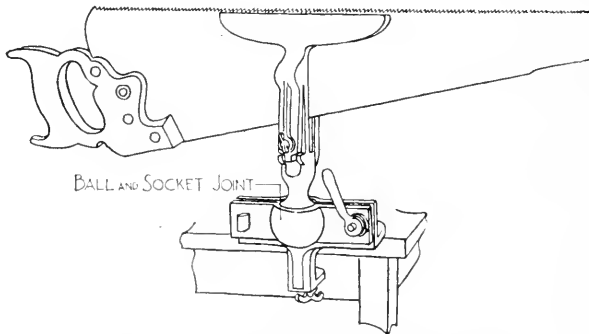

FIG. 111. SAW IN SAW CLAMP.

each tooth. In going over the teeth from the first side, a little of the facet made on the tooth tops by top-jointing should be left. In filing from the second side this will disappear in the main. Any teeth which still retain the

facets may be touched up after the two sides have been gone over with a uniform number of strokes to each tooth. Most of the cutting pressure of the file should be against the back of the tooth with just enough on the cutting

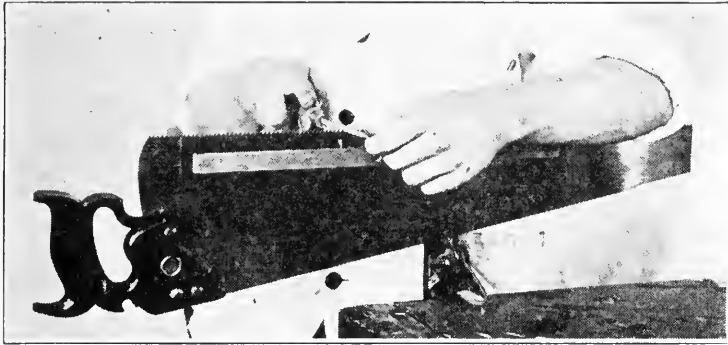

FIG. 112. FILING A RIP-SAW.

edge to bring it to a sharp aris. Where teeth vary in size, a change in the balance of pressure is necessary to reduce the large and increase the size of the small adjacent tooth.

If the saw is to be used for ripping, file straight across holding the file so that it shall cause the cutting edge of each tooth to make an angle of 90° with reference to an imaginary line passing thru the points, Fig. 112.

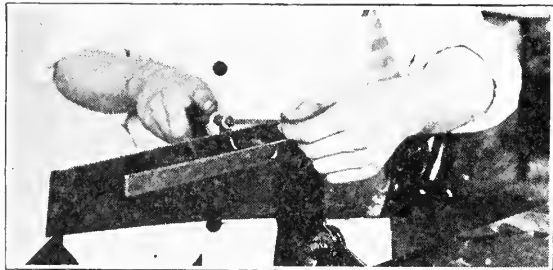

FIG. 113.
FILING A CROSSCUT OR HANDSAW.

In soft wood a little more hook, or pitch, or rake may be given. A pitch of 90° is quite

appropriate, however, where both soft and hard woods are to be cut by the same saw.

The crosscut, or handsaw is more difficult to file properly because of the necessity of producing an angle on the cutting edge of other than 90° , as well as requiring an inclination of the file to the horizon. Fig. 113 shows the angles approximately. These angles will vary with the kind of wood to be cut, whether hard or soft, and the rapidity with which the work is to be done. Only experience will acquaint one with just the proper angles. Fig.

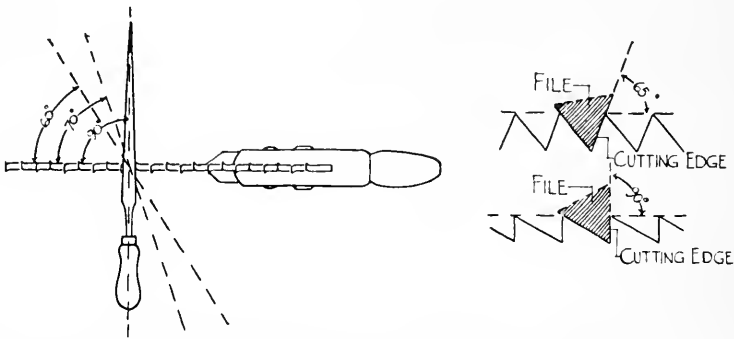

FIG. 114. FILING POSITIONS FOR CROSSCUT AND RIP-SAW TEETH.

114 indicates the angles ordinarily used in placing the file across the saw blade, top view. Fig. 115 shows two different angles, end view, commonly used in filing the crosscut-saw, also the effect upon the shape of the teeth. Either method is considered good practice; the second is a little more difficult to learn, unless a saw-clamp similar to the one shown in Fig. 111 is made use of. In this clamp, a ball-and-socket joint allows the saw blade to be inclined so that the file may be carried in a horizontal position, and yet have an inclination with reference to the side of the blade.

Where a saw is in fair condition, the beginner will find it well to carefully place his file between two teeth

and try, by this means, to determine the angles previously used.

Authorities differ as to whether the file should point toward the point of the saw or toward the handle. The balance of opinion seems to be slightly in favor of those

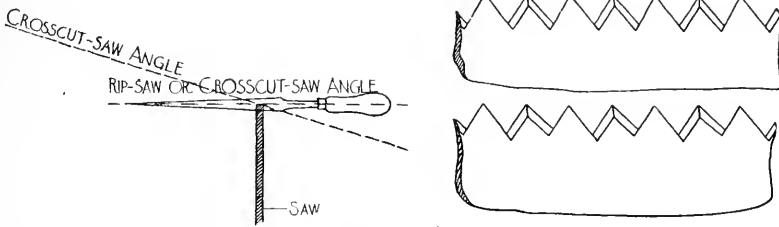

FIG. 115.

TWO ANGLES COMMONLY USED IN FILING CROSSCUT SAW.

who advocate holding the point of the file toward the point of the saw, filing the back of the tooth on the side nearest the worker and the cutting edge of the tooth on the farther side at the same time.

After a saw has been filed, either rip- or crosscut-saw, it should be laid flat, as shown in Fig. 116, and an oilstone

passed over its sides lightly once or twice to remove the wire edges produced in filing. This operation is known as side-jointing and causes a saw to cut smoothly.

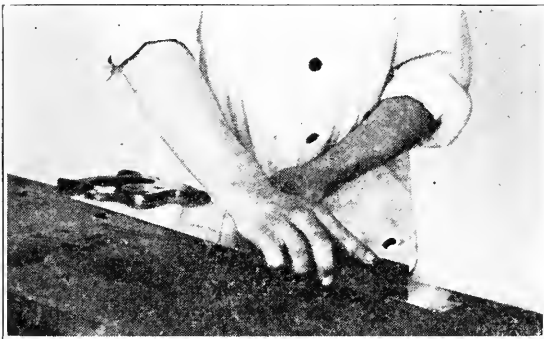

FIG. 116. SIDE JOINTING SAW TOOTH.

Compass, key-hole, bow or turning saws, etc., must cut both across and along the grain of the wood, and are therefore fitted half and half. That

is, the teeth are given nearly as much hook as the rip-saw while the fleam, or side angle, Fig. 113, is about 80° .

83. Sharpening Scrapers.—Scrapers may have either square or beveled edges. In either case the cutting edge is obtained by turning a burr.

First, grind or file the edge to the shape desired, then drawfile, Fig. 117. Leave the edge slightly rounded from end to end so that the corners shall not

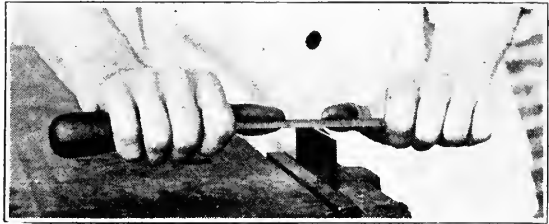

FIG. 117. DRAWFILING A SCRAPER.

“dig.” Where the scraper is to be held in the fingers or where a holder is used in which a screw is employed to spring the blade slightly, this curved edge is not necessary. The oilstone may be used to get a still smoother arris, the steel being moved as in Fig. 118.

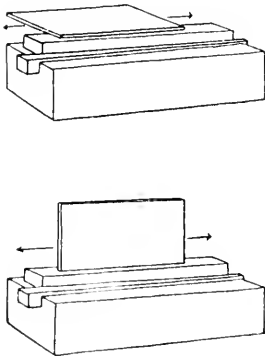

FIG. 118.



FIG. 119.

WHETTING A SCRAPER. TURNING A SCRAPER ARRIS WITH BURNISHER

Next, by means of a burnisher—a smooth piece of highly tempered steel—held at the angle shown in Fig. 119, drawing the tool toward you, turn the arris to the

angle A, Fig. 120. The stroke requires a steady, uniform pressure without change of angle. Now make a stroke as indicated at B, Fig. 120. Finally make a stroke at C. The extreme range is not to be over 15° . Failure to secure a cutting burr is most frequently caused by turning the burr too far. If by chance the burr is turned too far, it may be raised by drawing the point of the burnisher as in Fig. 121.

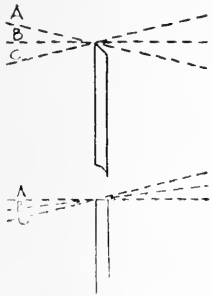

FIG. 120.
ANGLE OF
BURNISHER IN
TURNING A BURR.

It is not necessary to file the scraper every time it becomes dulled. The burnisher may be used to draw out the aris, Fig. 122, after which it may be turned over again in the usual manner.

For the satisfactory working of a scraper, steel of the right temper is necessary—not too hard and not too soft. The burnisher must be tempered sufficiently hard that the steel will not cut it. A drop of oil on the burnisher will assist.

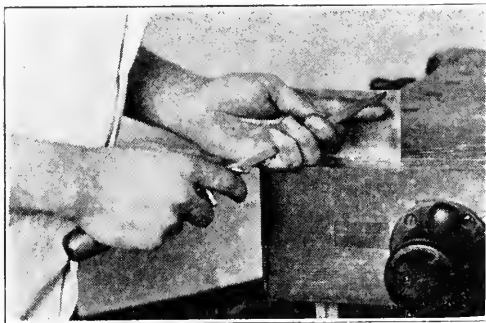

FIG. 121. RAISING BURR ON SCRAPER.

84. Sharpening Lathe Tools.—The first tool used in turning is the large gouge, called the roughing-out tool. This tool should be ground by holding it as in Fig. 123 and moving the handle in the arc indicated thereon. Give

the tool as much grind or nose as the hollow is deep—a wedge of about 30° , Fig. 124.



FIG. 122. DRAWING OUT BURR ON SCRAPER.

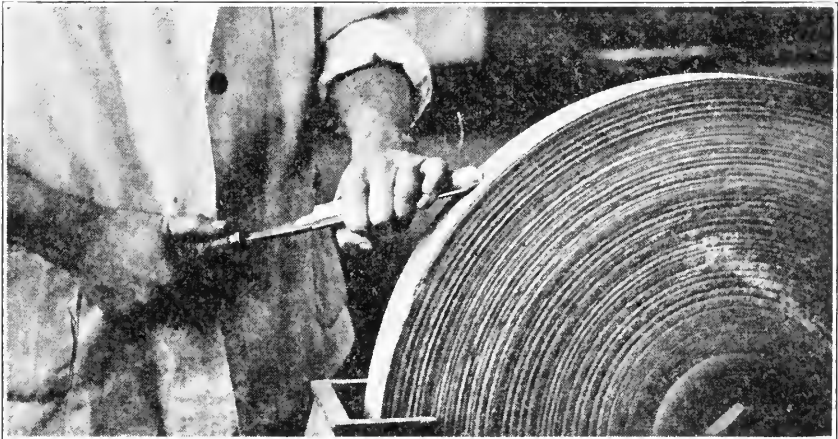

FIG. 123. GRINDING A TURNER'S GOUGE.

Holding both gouge and whetstone free, whet the bevel until a slight edge is turned; then, fitting the curved surface of the stone to the inner surface of the gouge so that no bevel shall be formed there, remove the wire edge.



FIG. 124. NOSE OF LARGE GOUGE FOR ROUGHING OFF.

The small gouge, like the large gouge, is ground with a nose equal to the depth of its hollow. There is one very important difference however; the small gouge

must have its lips ground farther up and around its sides and made very thin so as to give clearance when the tool is rolled over, as must be in making hollows and half-circles, Fig. 125. Fig. 126 shows the difference between the roughing gouge and the small gouge.

Skews should be ground with wedges of about 20° for soft wood, with a side angle of about 70° , Fig. 127. For hard wood the wedge should not be quite so acute. In whetting strive to have the whetted angle very similar to that of the ground.

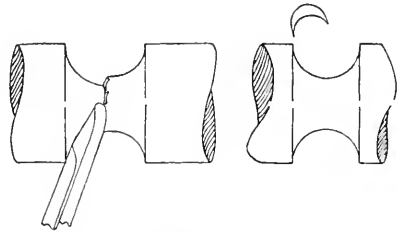

FIG. 125.
SMALL GOUGE IN ACTION.

The scraping tools should be given wedges of 45° , and be ground on one side only, Fig. 128. Scraping tools are more efficient when given a scraping burr. This is done by placing the tool on the oilstone in the usual manner, bevel down, and then giving several firm strokes as indicated by the arrows, Fig. 53. This produces a smooth burr different from the serrated edge obtained by whetting in the usual manner, and one not so easily dulled.

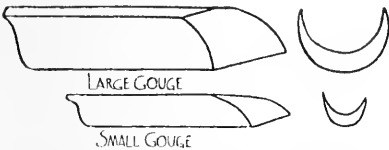

FIG. 126. SHOWING SHAPE OF
LARGE AND SMALL GOUGES.

85. **Sharpening Carving Tools.**—The principles involved in sharpening carving tools are the same as are involved in sharpening other edged tools, such as the paring chisel and gouge. It is necessary to have access to grinding wheels and slip stones of appropriate forms for the tools being sharpened. These forms are numerous, and, where carving is

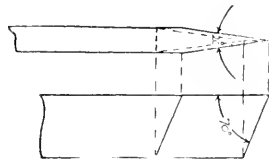

FIG. 127.
SMALL SKEW—
ANGLE FOR SOFT WOOD.

to be employed involving many kinds of tools, a special dealer's catalog should be accessible that appropriate stones may be selected.

86. Modeling.—This term is used to apply to the method of making objects of such irregular form that the judgment of the worker must be depended upon to give the correct result without the aid of gage and knife marks. The forming of a canoe paddle or hammer handle is a good illustration.

Generally a little forethought will show a way in which the piece of work may be partly laid out with knife, square and rule. To illustrate, take the hammer handle, Fig. 129. The steps will be as follows: First, prepare

a face side and a face edge, and square the two ends so that the piece shall have the length desired for the finished handle. Second, draw a center line on the face side, parallel to the face edge, and lay off on either side of this line two straight lines which shall indicate the amount of taper; also sketch in the lines of curvature.

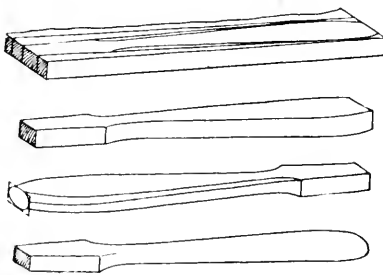

FIG. 129. STEPS IN MODELING
A HAMMER HANDLE.

work these surfaces as in the second step. Third, the piece may be laid off still further by drawing on the larger end the form of the ellipse which that end is to



FIG. 128.
BEVEL ON SCRAPING
TOOLS.

Plane the two edges to the tapering lines and square with the face side. Then cut to the curved lines, keeping the surface also square with the face side. In a similar manner lay off on the face edge a center line parallel to the face side, mark the taper and lines of curvature, and

assume. With spokeshave, judging the curves of the middle with the eye, work out the desired form. The steel scraper is to be used for finishing after the spokeshave has done its work.

87. Glue Pots.—Sometimes a steam glue pot, Fig. 130, is to be recommended because steam is conveniently near. The electric glue pot, Fig. 131, is rapidly superseding other types. It consists of a water jacket, a glue pot, and a heating element. Such heaters are made to give two and three different heats, a high heat for heating the water quickly, a medium heat for continuous work and a low heat for keeping the glue from chilling.

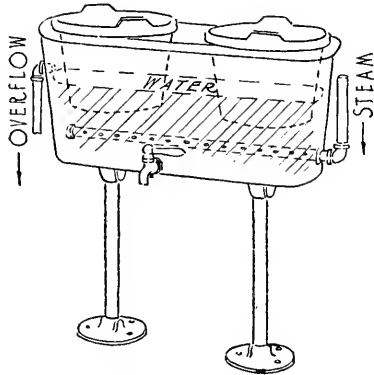

FIG. 130.
STEAM GLUE HEATER.

88. Surface Table.—Fig. 132 shows one type of iron surface table. Such tables are cast with reinforcing ribs to prevent warping after the tops have been planed true.

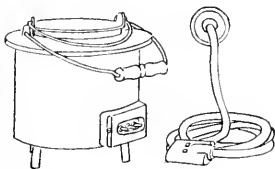

FIG. 131.
ELECTRIC GLUE HEATER.

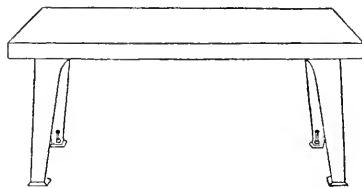

FIG. 132. PLANE TABLE.

The legs are adjustable for height. Tables such as this will be found helpful for a great variety of work, such as quick testing of surfaces for wind, scribing table or chair legs for uniform rest, etc.

CHAPTER III.

WOODWORKING MACHINES.

89. **Introductory.**—The fact that certain woodworking machines are described herein should not be taken by the student as evidence that he is at liberty to make use of such machines should they be a part of the shop equipment. Woodworking machines are, of all machines, among the most dangerous. The consequences of carelessness or ignorance may result in lifelong injuries of a most serious nature. Some of the machines, such as the lathe, band-saw or scroll-saw and trimmer may be safely used after instructions, by large classes, when properly safeguarded. Other machines such as the jointer, the circular saw, surfacer, boring machine, mortiser, etc., should be used only by students in classes of such size that careful instruction and constant oversight may be given by the teacher. Other machines, such as the tenoner, shaper, etc., are described that the student may have information of a more extended nature about woodworking methods, but they are not recommended for student use except under special arrangement.

In vocational and trade schools, with ample time for careful instruction, and under favorable conditions, such restrictions may not apply, tho the danger is none the less real. "Safety first" should at all times be the first consideration.

Manufacturers who have made a careful study of accidents which occur in factories have found that, while safety devices will not often times prevent accidents, they at all times serve as reminders of the need for care.

90. **Order of Procedure in the Use of Machines.**—The order of procedure in the use of the various machines in the squaring of stock to dimensions, and the relation of this work to that done with hand tools is indicated in the following table.

Squaring Up Stock

By Hand Tools

By Machines

1.—First operation, getting out stock to convenient working sizes—	
Hand saws	Swinging cut-off saw
2.—Preparing face side and face edge—	
Hand plane	Hand planer or jointer
3.—Working to thickness—	
Gage and hand plane	Surfacer or planer
4.—Working to width—	
Gage and rip-saw	Circular rip-saw
5.—Reducing to exact width—	
Hand plane	Jointer
6.—Squaring one end—	
Try-square and saw	Circular crosscut-saw
7.—Securing length—	
Rule, try-square, saw	Circular crosscut-saw

In the use of such machines, face sides and face edges are to be kept against the table tops or the fences or both. The presence of graduated scales on the machine saw and on the planer or surfacer makes the use of the marking gage unnecessary. The presence of fences which may be set to predetermined angles makes the use of the try-square unnecessary as a means of laying out and testing.

In ripping to width on a machine, about $\frac{1}{16}$ " is allowed for planing. This is removed by means of the jointer.

91. **Swing Cut-Off Saw.**—As this machine comes first in the operations with woodworking machines, it will be described first.

When stock is taken to this saw to be cut it is always in long lengths. If the saw were stationary as are other types of cut-off saws, the operation of pushing the long board past the saw would be found very awkward. The

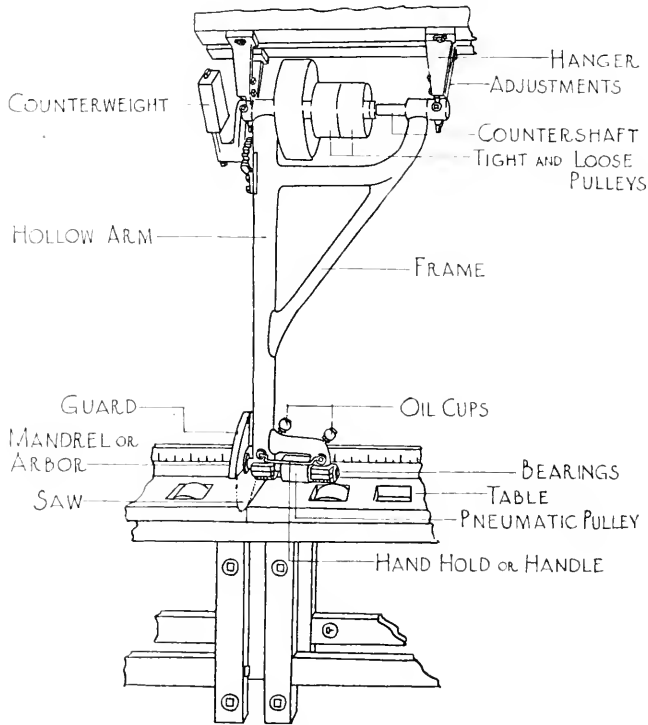

FIG. 133. SWING CUT-OFF SAW.

operation of cutting up a long board is made easier by making a stationary saw table on which the board may lie, and swinging the saw in such a manner that it may be moved thru the board, Fig. 133.

The heavy frame or arm, as shown in the illustration, altho weighing several hundred pounds, is always hollow. The shaft and pulleys, which are supported at the top of

the arm, serve as countershaft for the machine, one of the small pulleys being tight and the other loose, the large pulley carrying the belt which drives the saw arbor. On this make of machine a pneumatic pulley will be found upon the saw arbor. This type of pulley gives clinging power to the belt, the grooves preventing "air pockets" from forming between belt and pulley, and is used on other high-speed machines as well.

Swing saws are made to swing from a wall, Fig. 134, as well as from a ceiling, a modified type of hanger bracket being used.

If a swing saw were to be hung from either ceiling or side wall without the counter weight, Fig. 133, the heavy frame would hang in a vertical position. As this would tend to throw the saw over the board and in the way when not in use, a heavy weight is attached to the frame on a system of lever arms so adjusted as to throw the saw back and out of the way when not being pulled forward by the operator.

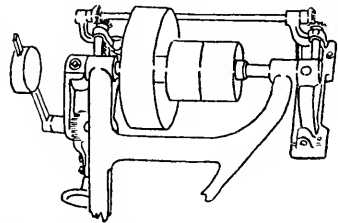

FIG. 134. SWING CUT-OFF SAW WALL HANGERS.

When not in use the lower edge of the saw rests just back and below the table on which the work is lying. To maintain this relative position of saw and table where different sized saws are made use of, or in first adjustments of the machine to its table, or where successive filings have reduced the size of the saw, some adjustment must be possible. This adjustment on this machine is in the hangers, and by means of it the whole frame may be moved vertically about 6 inches.

Such saws should be provided with a guard similar to the one shown in the illustration. Such a guard should hang well down and over the saw.

Such saws on light factory work are usually 16" in diameter and are run at a speed of 2,400 R. P. M., requiring about three H. P for the fairly heavy work it can do.

92. Operating a Swing Cut-Off Saw.—(1) On the saw table, which is generally 12 feet long, will be found a scale graduated into feet, inches and quarter-inches. By means of this scale, place the board for a cut of the required length. Since the cutting is for rough lengths only, a quarter-inch scale is of sufficient accuracy. (2) As the saw runs or revolves toward the operator, it has a tendency to eat into the stock. In pulling the saw toward him, the operator should hold his arm lightly rigid so that he may resist a sudden thrust toward himself. Owing to this tendency of the saw to eat into the stock, a beginner will usually pull the saw into the stock so rapidly, at the first attempt, as to choke the saw, that is, the saw will stop, the belts slipping. In such a situation the operator should maintain control, pushing the saw back until the belts may regain their driving speed. A second attempt ought to meet with success, provided the first has indicated the error in manipulating the machine.

93. Hand Planer or Jointer.—The hand planer or jointer, Fig. 135, takes the place of the hand plane, and in most cases is second in line of machine operations. This machine is to be used in preparing a face side and a face edge. When a board is properly fed on such a machine its broad surface can be taken out of wind and made true, and the first edge can be made straight as to its length, and square to the face side. Jointers range in size from 6" to 24" and are run at a speed of about 4,000 R. P. M.

94. "Setting-Up" a Hand Planer or Jointer; Adjustments.—The jointer is perhaps the most difficult of all machines for the beginner to learn to operate because it

takes the most delicate adjustments. The most common difficulty is that of securing the proper adjustment of the two beds or tables, one with reference to the other, and each with reference to the knives.

Were the two beds and the knives adjusted to have the same level, there would be no chance for a cut. By lowering the front bed below the level of the knives, a cut is made possible, the amount of cut depending upon the amount of drop of this table or bed. The rear bed

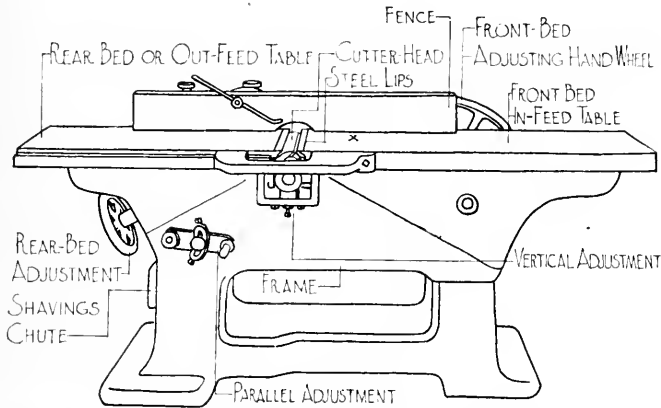

FIG. 135. HAND PLANER OR JOINTER.

is intended to carry the stock after it has been cut and for this reason should be allowed to remain on the same level as that of the knives at their highest point of revolution.

If the operator is in doubt as to whether the machine is set up properly for straight work, the first thing is to determine whether the rear bed is at exactly the same level as that of the cutting edge of a knife when in its highest position. This can be determined by taking a scrap piece of stock and running it over the knives a few inches. As the newly-cut surface passes over the rear bed

there should be no space showing between the stock and the bed, Fig. 136.

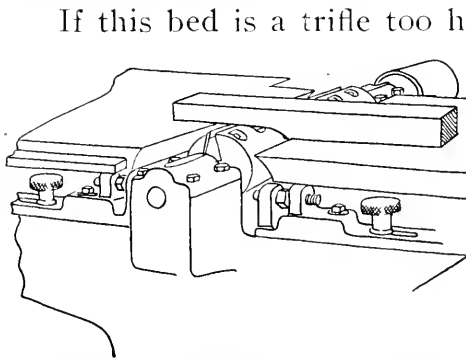

FIG. 136. SHOWING REAR TABLE SETTING OF JOINTER.

If this bed is a trifle too high ($1/100''$ is sufficient to cause trouble), the result will be a slight raising of the stock as it is pushed forward, so that a board, tho its width were uniform at the beginning of the operation, would not be afterward. A cut might begin with a depth of $\frac{1}{8}''$ and end with $\frac{1}{16}''$, due to the fact that the rear table was slightly higher than the knives, Fig. 137. Uniformity of width in stock can be maintained only by taking a uniform cut the full length of the stock.

Suppose the rear bed were too low. As the freshly cut surface passed over the rear table, light would show between it and the table. This would mean that the



FIG. 137. EFFECT OF HIGH REAR TABLE ON JOINTER.



FIG. 138. EFFECT OF LOW REAR TABLE ON JOINTER.

stock was resting upon the front table only. As the stock passed forward it would reach a place where its fore end would drop until it rested on the rear table, producing a crook in the edge. As the rear end of the stock passed over the knives, dropping from the front table, a notch would be cut from it as shown in Fig. 138.

The remedy, obviously, is to raise the rear bed to the level of the cutting edge of the knives.

The rear table is raised or lowered only for special set-ups, such as tapering, chamfering and a few other operations. For all straight jointing the relative positions of beds and knives will be as stated. In Fig. 135 will be noticed an adjustment on the side of the machine just be-

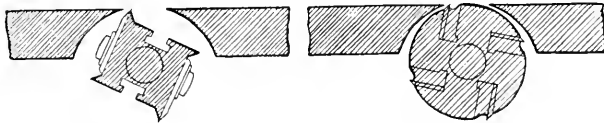
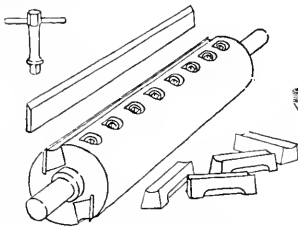

FIG. 139. CUTTER HEADS.

low the rear or out-feed table. Occasionally a rear table may have its surface out of parallel with the front. This adjustment is used to correct such an error. Such lack of adjustment would cause a convex or a concave cut to be made. When this adjustment has been set so that the rear table is parallel to the front one, it is set securely and left so, there being seldom any occasion for changing it, unless, perhaps, thru wear caused by long use of the machine.



A SAFETY HEAD.

FIG. 140.

95. Cutter Heads: Set-Up and Fitment of Knives.—In Fig. 139, cross-sections of two types of heads

are shown. The older type is so dangerous that it is being universally supplanted by the newer type, the circular or safety head. In this newer type the head and its shaft are turned from a solid steel forging. The knives are made of thin air-hardened Tungsten steel, and are held in position by set-screws pressing against a block or blocks of steel which, in turn, hold the knives, Fig. 140. Such safety heads, should the fingers

by accident be pressed upon them, will clip off the flesh painfully. This, however, is not to be compared to the result of such a movement on the old type, the loss of the fingers being a usual sequence.

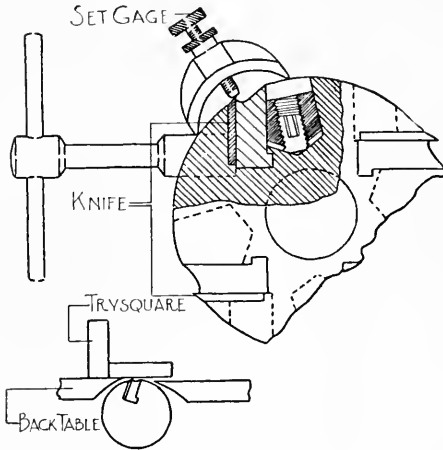

FIG. 141. TESTING JOINTER KNIVES FOR POSITION.

with jointing devices which make possible a practically perfect setting of the cutting edges, Fig. 142. Such a jointing device consists of a piece of emery so placed that it may be moved along the knives as they are revolved at a slow speed. This attachment is also used in securing the first setting of the knives. The two steel rolls, Fig. 143, indicate the proper setting, the knife edges being placed so that they just touch these. It is needless to say that the most painstaking and careful effort is required on such work. Carelessness, such as the leaving of some of the set-screws of the cylinder head loose can mean but serious disaster to the machine if not

In setting knives in a head it is necessary for smooth work that the cutting edges shall be uniformly set with reference to their circumferential movement. Fig. 141 shows two methods of testing knives for proper projection. In addition to this, the latest types of machines are provided

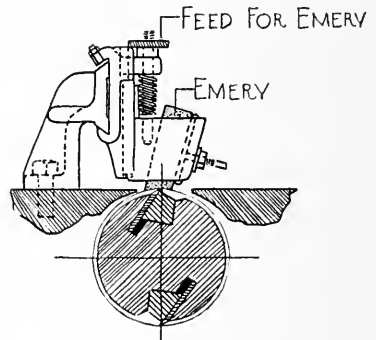

FIG. 142. JOINTER FOR HAND PLANERS.

to the worker. A second "look" all about is imperative on all such work before throwing on the power.

It is possible on some machines to secure an electric grinder which can be attached to the same bar used in setting-up and jointing the knives, Fig. 144. Such emery wheels are disc-shaped and the mechanism adjustable for depth. Such jointing and grinding attachments may be used upon surfacers as well as upon jointers.

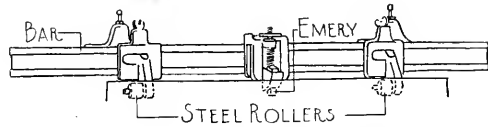

FIG. 143. JOINTING AND SETTING ATTACHMENT FOR HAND PLANERS AND SURFACERS.

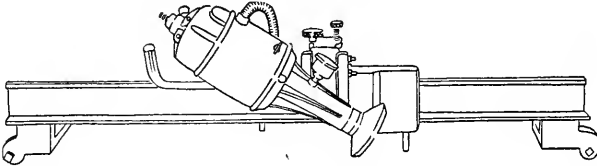

FIG. 144. ELECTRIC GRINDER FOR HAND PLANERS OR SURFACERS.

96. Operation of a Hand Planer or Jointer.—As the depth of the cut is determined by the distance the stock

is below the knives when it is in position to be fed over the in-feed table, the first thing for the operator to do is to determine whether the machine is set to give the amount of cut his work requires. On all modern jointers where the fence is attached to

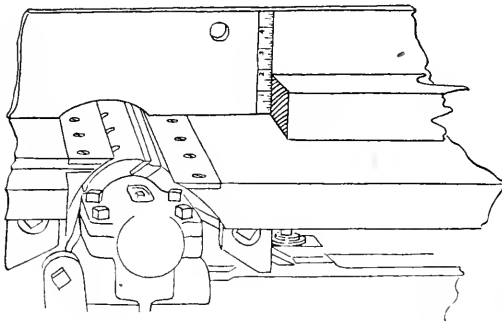

FIG. 145. DEPTH GAGE FOR JOINTER.

the rear table, one can see at a glance at just what depth the machine is set to cut. The amount of opening between the lower edge of the fence and the in-feed table

indicates the depth of cut, x , Fig. 135. Some machines have depth gage or thickness scale fastened to the fence, Fig. 145.

When a piece of stock is placed on the in-feed table to be surfaced it is usually rough and irregular and in wind. As it passes over the knives a new surface is formed and this new surface slides over onto the out-feed

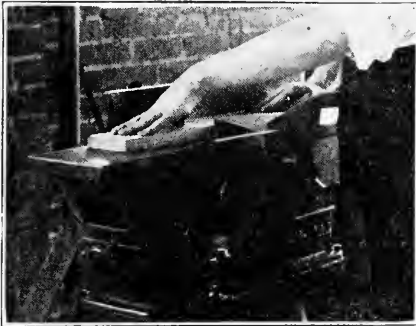

FIG. 146. JOINTING A SURFACE.

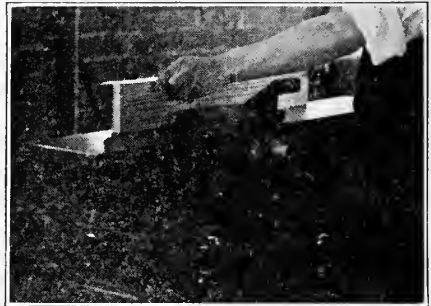

FIG. 147. JOINTING AN EDGE.

table. It is very essential that the stock be held down tightly on this rear table so that the remainder of the cutting may give a surface which shall lie in the same plane as that first cut. Just as soon as the stock has a good bearing on the rear table, all the weight and attention of the operator should be placed upon it at that point, the stock being pulled over the knives rather than pushed. Figs. 146 and 147 show the proper position. Fig. 148 shows a device which will be found handy in planing springy narrow stock. Fig. 149 shows the manner of using it.

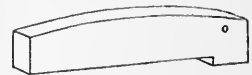

FIG. 148. DEVICE FOR PLANING SPRINGY NARROW STOCK.

If a piece of stock has been ripped to $4\frac{1}{8}$ " and is to be jointed to a width of 4", the jointer should be set to take a $\frac{1}{8}$ " cut and the stock run thru. It is considered poor

practice to make two or more cuts for this or smaller cuts.

Short stock should not be run over a jointer. Stock shorter than 10" should not be machine jointed by a beginner; it is a dangerous proceeding.

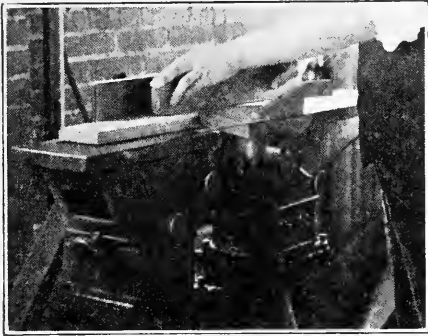

FIG. 149. MANNER OF USING PLANING DEVICE.

The planing of long tapers is accomplished by varying the relative positions of the tables with reference to the planer knives, as is indicated by Fig. 137.

For planing short tapers, as on the bottoms of furniture posts, a block of scrap stock is placed under the top or back end of the post at such a relative position as to raise the rear end of the post to the angle of inclination wanted for the taper. The post is then run thru in this inclined position, bottom end first. Such an operation requires skill on the part of the operator.

97. Jointer Guard.

—A jointer should never be run without a guard. The best guard is the one which covers the knives completely at all times and is least cumbersome. Guards

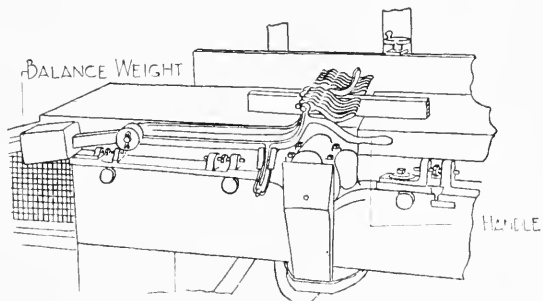
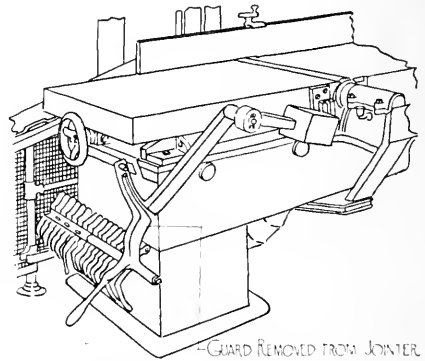

FIG. 150. JOINTER GUARD IN PLACE.

may be had which compel the operator to pass all flat stock under it, Fig. 150. When edge stock is run, the guard is pulled back just far enough to let the stock

pass thru edgewise between the fence and the end of the guard. A weight or a spring serves to push the end of the guard up to the fence, once the stock has passed thru, on certain types of guards.

98. **Planer or Surfacer.**—The planer, or surfacer as it is generally called, Fig. 152, is the machine which reduces the stock to thickness. It will not remove wind, as beginners sometimes think. The jointer or hand planer must be used to prepare the first surface, after which the surfacer is to be used to plane the reverse surface and the stock to required thickness.



—GUARD REMOVED FROM JOINTER
FIG. 151. JOINTER GUARD
REMOVED.

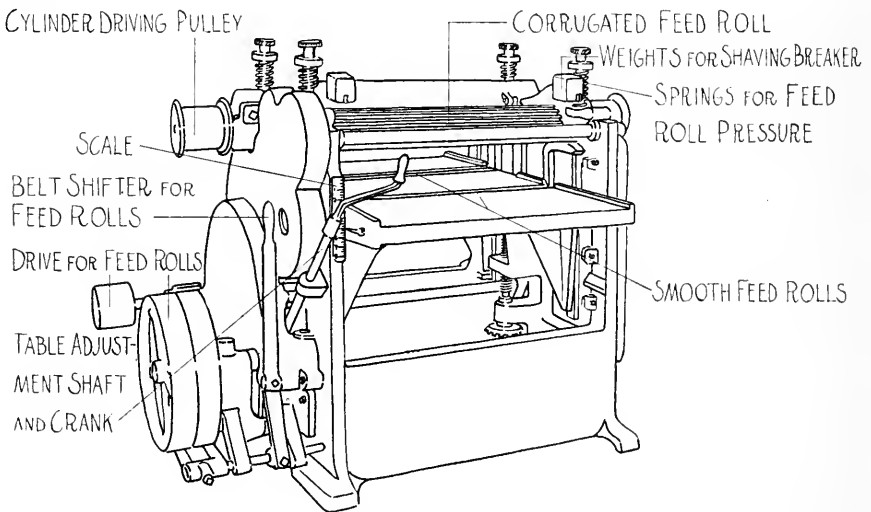

FIG. 152. PLANER OR SURFACER.

While this machine is comparatively easy to manipulate, it requires careful study before its adjustments can be mastered.

Most planers are double belted, that is, the driving is done thru a belt at each end of the cylinder. Belt shifters should be near the operator's position so that the machine may be quickly stopped should anything go wrong. It should be noted that the belt and gears that drive the feed rolls are entirely separate from the belt which drives the cutter head. This is so arranged that the feed rolls may be stopped instantly in case of accident, while the momentum of the cylinder would keep it running for perhaps a minute after its power is shut off. The lever which governs the feed rolls may be seen at the front and left of the machine in Fig. 152.

Some surfacers for large factories are made with double cylinders so that both sides of a board may be planed at one operation.

From 4 to 7 H. P. are required, and the speed of the cylinder should be about 4,200 to 5,000 R. P. M.

The construction of the cutting or cylinder head is similar to that of the jointer, either square or circular, the circular superseding the square.

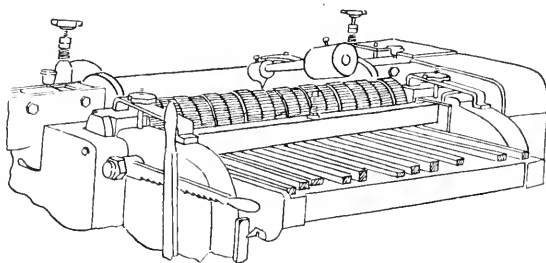

FIG. 153. SECTIONAL FEED ROLLS.

Some machines are fitted with sectional feed rolls, Fig. 153, which consist of small vertical sections placed on an eccentric center so as to admit different thicknesses of stock under each section. The purpose of such a feed roll is to prevent pieces of slightly thinner stock from being kicked backward out of the machine, endangering the worker, should he happen to be standing in front of the in-feed at the time. Each section is composed of an

outer ring which encloses four radial sections, each carrying a helical spring. These springs permit a vertical variation of $\frac{3}{16}$ " , if required. With such a feed roll a sectional chip breaker is used.

Smoothness of cut, other things being equal, depends upon the feed. Feeds, like cylinder speeds and machine sizes, depend upon the particular make of machine. With a cylinder speed of 5,000 R. P. M. a machine may have feeds of 16', 21', 27' and 33' per minute, or more. Soft woods may be run with a feed of 75' per minute, if desired. Cheaper machines will have fewer variations in feed, possibly only one feed as 24' per minute for a cylinder speed of 4,500 R. P. M. Manufacturers furnish such data with their machines. Sizes will vary from 20" to 42", and even greater, with a capacity for planing stock 7" to 8" thick. A good machine will plane stock as thin as $\frac{1}{8}$ " , or even $\frac{1}{16}$ " .

99. Operation of a Surfacer.—Taken for granted that the wind has been taken out of the first surface upon the hand surfacer, the operations required to reduce to thickness are as follows: On the front of the frame will be found a scale and near it a handle or hand wheel. This handle is to be used to move the table up or down as required, the index and scale indicating the amount. It will be noted that in the surfacer the knives and revolving cylinder are above the work; in the jointer they were below. On the jointer, the surface to be cut is placed down; on the surfacer this is reversed, the surface to be cut being turned up with the face side down. Determine the setting of the machine for the first cut by measuring the stock at the thickest place. Set the machine by means of the scale just mentioned. The amount of cut will be determined by the hardness or softness of the wood and the width of cut, and, to a

certain extent, by the rate of feed. Too deep a cut will stall the machine, causing the feed belts to slip and the feed rolls to stop. In such a case the machine would best be stopped and the depth of cut decreased, the feed being thrown off until the cylinder can "pick up its load" again. A good operator learns to know by the sound of his machine when the load or feed is too heavy, and either throws off the feed promptly until the knives can pick

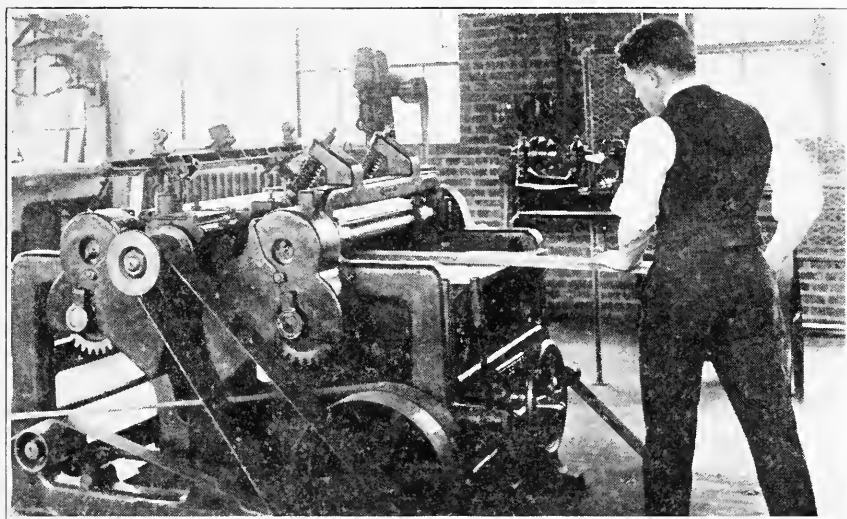

FIG. 154. FEEDING A SURFACER.

up speed again, or, if the machine still fails to find relief after one or two such reliefs, decreases the cut by lowering the table slightly. In general $\frac{1}{16}$ " will be a sufficient cut, for a beginner, where a machine is in good condition. The stock must be run thru successively until the proper thickness is obtained. Where a number of pieces are to be planed, the thickest is planed first, the others being added in turn as soon as their thickness permits.

As the stock is pushed forward on the table, Fig. 154. (1) the first thing to act on it is the corrugated feed roll.

This revolves in such a direction that the stock is pulled into the machine. This roll, like the smooth feed rolls, is held down by means of weights or by heavy springs attached to each end of the roll. (2) After leaving this roll the stock proceeds a few inches when it comes in contact with the chip breaker, Fig. 155. This chip breaker serves the planer knives just as the chip breaker or cap-iron serves the hand planes. It, too, is held down on the board by weights or springs and is so attached that it moves concentric with reference to the knives and cylinder. (3) Next the stock encounters the cylinder knives revolving as shown in Fig. 155. The shavings are carried up and thrown out as shown. (4) Leaving the knives, the stock passes under a back pressure bar the purpose of which is to hold the stock down firmly while the knives do their work. It is regulated by springs and must be adjusted

so that the stock as it leaves the knives may pass accurately underneath it. On some machines the distance between this back pressure bar and the chip breaker pressure bar is but $1\frac{1}{8}$ ".

As stock must be held firmly by feed roll and pressure bar, an attempt to run stock which is not at least several inches longer than the distance between feed roll and pressure bar will prove futile if not disastrous. (5) The stock next passes between the two rear feed rolls, designed to pull it thru after the first set of rolls have ceased to work upon it.

While a surfacer is not a very dangerous machine to

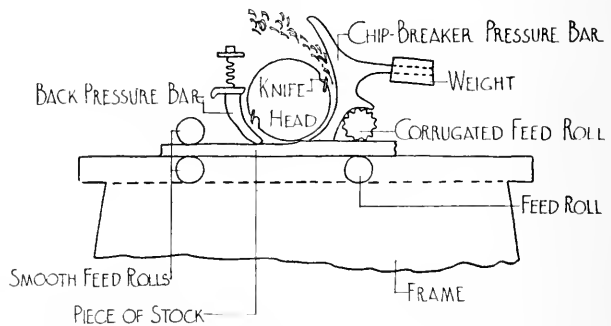

FIG. 155. SECTION THRU A SURFACER.

operate, the operator should not stand directly back of, and in line with, stock being planed, nor should he make a practice of stooping down and looking into the throat of the machine unless he stands well to one side. Pieces of stock are often kicked backward out of the machine with great force. The sectional or flexible feed roll with its chip breaker reduces this danger.

100. Adjustments on Surfacers.—Feed rolls once adjusted seldom require new adjustment except thru wear. The action of their adjusting devices will be evident upon inspection. Table rolls should be carried no higher than is absolutely necessary to secure a bearing for the passing stock. The corrugated roll should have no more pressure than is needed to cause it to move the stock. The rear roll will be hung with reference to the knives, as also is the corrugated roll, and adjusted with no more pressure than will insure transmission of the required moving power. Detailed instructions are usually provided by the manufacturers.

Adjustment of planer knives is a frequent requirement. The old style square head is so little used in modern shops that little attention is given it here. Modern machines are provided with adjusting devices such as that shown in Fig. 143, so that setting up of knives becomes a comparatively easy matter. This device is operated just as for the jointer. The bar remains a part of the machine on a surfacer, being merely swung up and back out of the way. The two rollers at either end of the bar assist in the setting, and the emery joints the knives to uniform cutting positions when properly set.

On the old style, the worker must determine his knife settings by placing parallel blocks on the table under the cylinder, adjusting the knives as best he can. Experience makes for proficiency but the results are not to be com-

pared with planing where the jointing device is available.

101. **Circular Saws.**—Possibly the circular saw can be used for as great a variety of purposes in a shop as

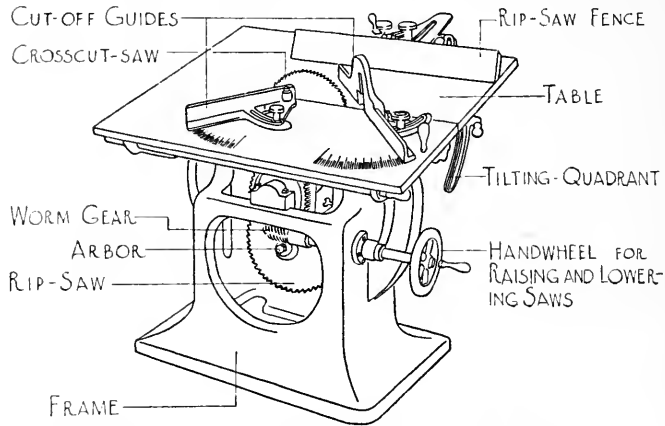

FIG. 156. UNIVERSAL CIRCULAR SAW TABLE.

any other machine; it is also about as dangerous as any other, unless well guarded, with the possible exception of the shaper and tenoning machine. Among the attachments which may be placed upon the saw arbor are the following: circular, rip- and crosscut-saws, gaining heads, grooving saws, and even molding tools.

Saws are made in two different styles—the universal or double arbor machine, Fig. 156, and the single arbor machine, Fig. 157.

The universal saw is composed of the following principal parts: (1) frame of cast iron; (2) table, which is of cast iron planed true on its top surface. The right-hand side or section is stationary but the left is on rollers so

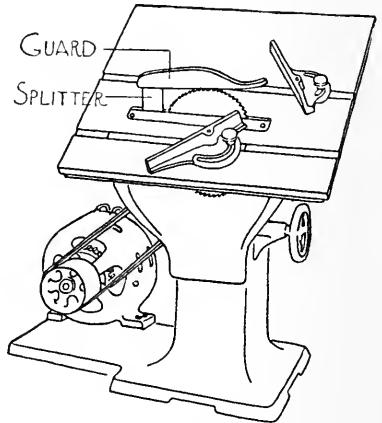

FIG. 157. SINGLE ARBOR CIRCULAR SAW.

that it may be moved backward and forward with the stock being cut, if desired. When not so used a stop under the table holds it in position; (3) a ripping fence so arranged as to be adjustable from side to side that different widths of stock may be cut (a graduated scale on the table top assists in setting this fence); (4) two crosscut guides or miter cut-off gages which can be adjusted to any angle with reference to the saw; (5) tilting quadrant which makes possible the tilting of the table top from a level position to an angle of 45° ; (6) raising and lowering device by means of which the arbors may be made to revolve, bringing either the crosscut- or the rip-saw above the table to any desired height up to the limit of the saw; (7) two arbors, one carrying a crosscut- and the other a rip-saw; (8) the saws one of which can be quickly revolved into position by a hand wheel.

The single arbor saw may be changed from a rip- to a crosscut-saw by raising the table and changing the saw, a matter of releasing a nut, changing saws and replacing the same, the nut being turned counter clockwise to tighten.

The cutting or rim speed of a circular saw should be approximately 9,000 feet per minute. Too high a speed will cause a saw to heat and buckle and run badly. A saw, on the other hand, will not run well at too low a speed. Heating of a saw at the center may be caused by lack of sufficient set in the teeth. If at the rim, it may be due to the fact that the backs of the teeth are too high for the points.

The speed of the arbor of a 10" to 14" saw will be about 3,000 R. P. M. About 5 H. P. is required.

Every machine should be guarded just as far as is possible. Fig. 158 shows a good type of guard for the circular saw. The follower is a good thing in that it

prevents the operator from reaching under the guard at the back in an effort to remove sawed stock or waste.

102. Operation of Universal Saw.—The simplest operation is that of ripping stock to a required width. (1)

See that the rolling section is set so that it will not move backward or forward by setting the stop, Fig. 159. Also see that the table is clamped so that it cannot move laterally, by fastening the clamp under the table near the stop controlling the backward and forward movement. This lateral adjustment is used when it is desired to

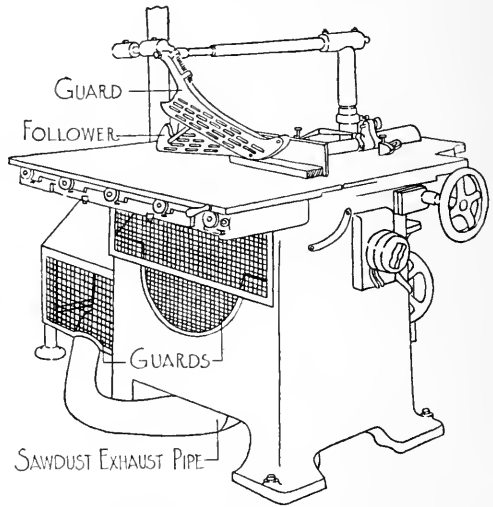

FIG. 158. SAW GUARDS.

remove a saw from its arbor, or when it is desired to make use of a wide grooving or dado head. (2) Release the clamp on the ripping fence and set the fence by means

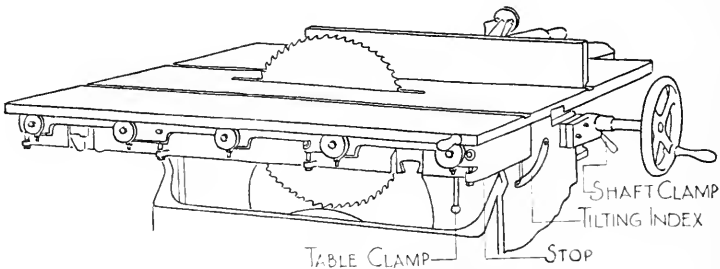

FIG. 159. TABLE ADJUSTMENTS.

of the scale to the required width of stock. Make the final adjustment by means of the micrometer adjustment after setting up the main clamp. This universal ripping

fence may be used on either side of the saw. By means of the quick adjustment a variation of about 12" is possible. Where greater width than this is wanted it can be got by moving the locating pins of the fence to a second set of holes in the table. The fence may be moved backward or forward on the table, parallel to the saw, 9". The face of the fence may be adjusted with reference to the table top from 90° to 45°. (3) By means of the hand wheel at the back of the machine, raise the

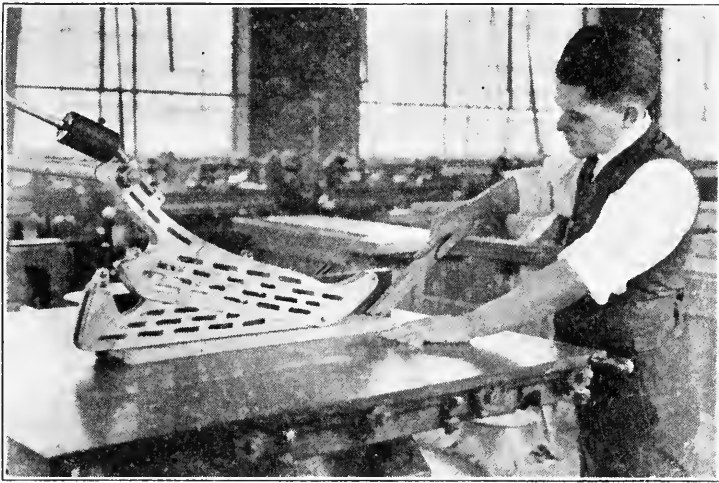

FIG. 160. RIPPING NARROW STOCK.

rip-saw above the table to a height but slightly greater than the thickness of the stock to be ripped. Notice the tilting index to see that it is as it should be. The machine is now ready for the power.

A circular saw, being a very dangerous machine, will require the closest of attention at all times. This is especially true upon such work as requires the removal of the safety guard, as in tenon work. The operator should stand up close to his machine and far enough to

the left of the stock he is ripping so that, should the stock be dropped on the saw or get thrown up so that the saw teeth catch it, he will not be in line with the flying piece. A saw will throw any piece of wood dropped upon it, or which may get upon it thru loose manipulation, with great violence. The operator should keep to one side of his stock.

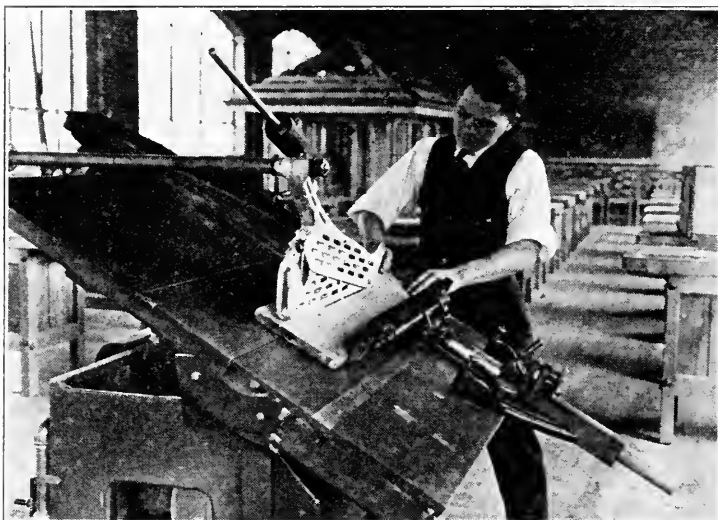

FIG. 161. RIPPING BEVELED EDGE STOCK.

A second danger, already hinted at, is that caused by carrying the saw high above the stock being ripped. A $\frac{3}{4}$ " piece of stock need have but 1" of saw projection above the table.

Fig. 160 shows how stock is to be handled where the space between saw and fence is close. The stick has a V-notch in the end against the stock to prevent its slipping off.

A saw when used for ripping can and should have a guard over it.

Fig. 161 shows the tilted table, the hand-wheel at the side of the machine being used for this; with the fence on the movable section.

In cutting stock to length, the miter cut-off gage, Fig. 162, is used. This gage has a groove into which may be fixed a stop rod, either 18" or 36" in length. The machine is set up as previously described, but with the cross-cut-saw out and the

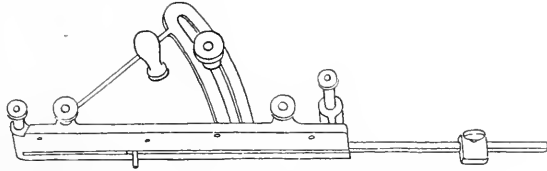

FIG. 162. MITER CUT-OFF GAGE.

rolling table released. The stock is placed against the stop and the gage, and the roller section with stock shoved forward. The stop, Fig. 162, is set for short

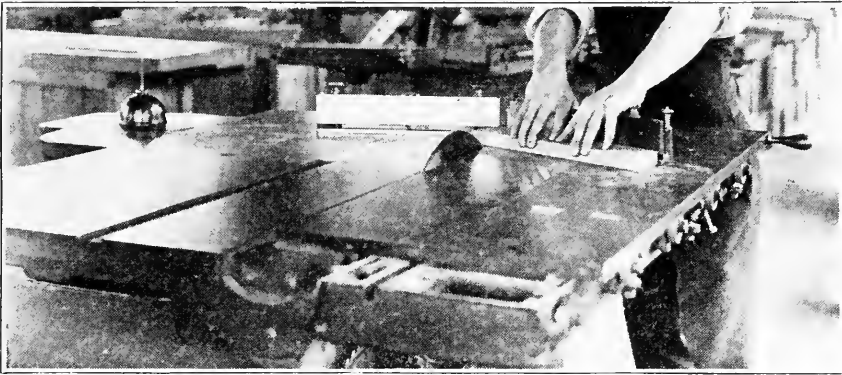

FIG. 163. SAWING SIMPLE MITERS.

stock the end of which will rest against the pin. For long stock the rod is turned end for end and the stop with thumbscrew made use of.

Figs. 163 and 164 show cut-off gages set ready for cutting stock at miters, simple and compound. They give ranges from 30° to 135° .

Fig. 165 shows a universal miter gage. These gages, two in number, operate in grooves in the table top, made by the removal of steel strips used for filling when universal gages are not in use. These cut from 30° to 150° .

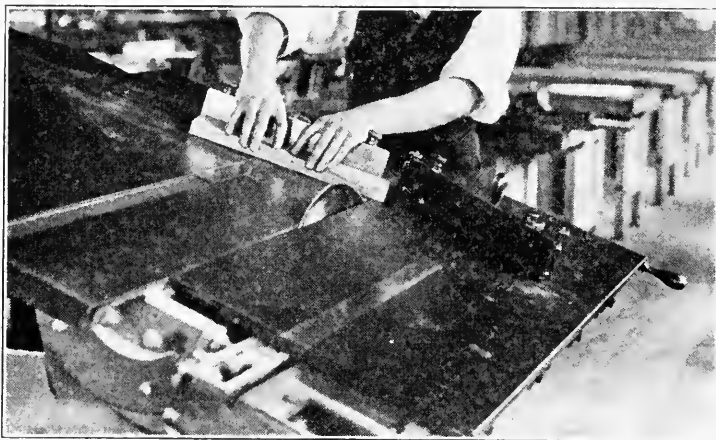

FIG. 164. SAWING COMPOUND MITERS.

It is possible to cut stock to length using the ripping fence as a stop. To obviate the binding of the stock between saw and fence with danger of a kick-back, a metal clearance block is provided to be attached to the fence, Fig. 166. The stock is placed with its end against this to get its position for the saw. Upon pushing the table and stock forward the end of the stock is freed of the metal block, thus giving clearance between fence and saw for the cut off part.

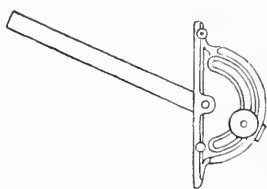

FIG. 165. UNIVERSAL MITER GAGE.

103. Cutting Tenons with Universal Saw.—The universal saw may be used in cutting tenons. (1) Place the cut-off guide for a square cut. (2) Release the roller

section. (3) Place the ripping fence and attach the metal clearance block. (4) Adjust the fence for the length of

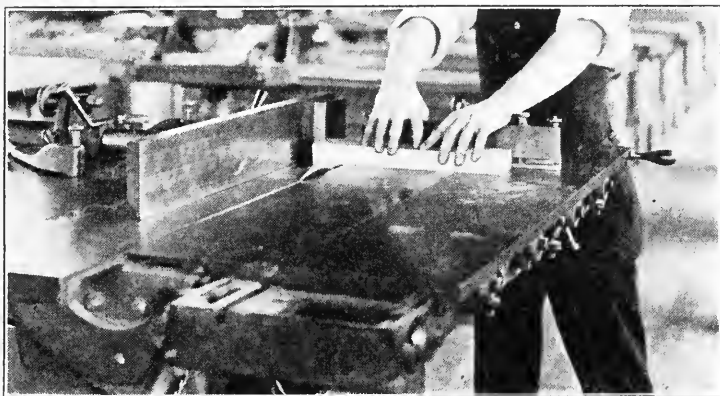

FIG. 166.

USING THE CLEARANCE BLOCK—FIRST STEP IN SAWING TENONS.

tenon required, considering the location of the saw kerf. (5) Raise the crosscut-saw the amount required to cut the depth of shoulder for the tenon. Clamp the shaft of

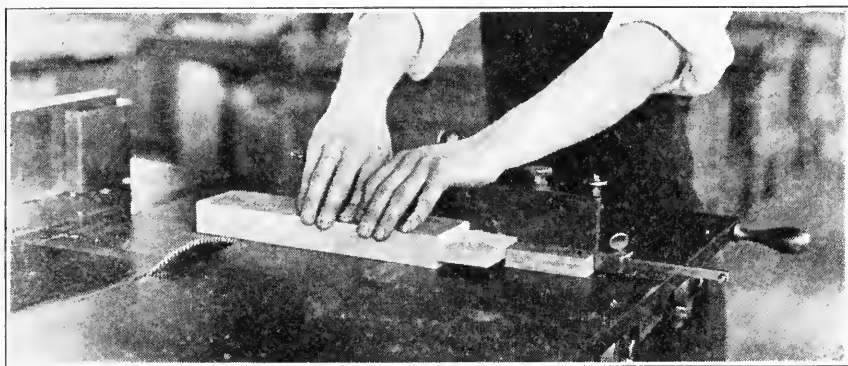

FIG. 167. SAWING TENON—SECOND END.

the hand-wheel just used in raising the saw so that it shall not move. (6) Run thru all members taking this

depth of cut. (7) If necessary, reset the saw for the shoulder cuts or kerfs on the edges of the stock.

(8) The next step consists in cutting the shoulders of the reverse ends. It is essential that the lengths shall be determined from the end first used against the ripping fence. Draw the ripping fence back out of the way and place the stop as in Fig. 167. Place the stock with the kerfed ends against this stop and run the other ends over the saw as before. Where care has been taken to secure uniform length on all pieces, and that should be the aim, it will be safe to work the second ends against the ripping fence as in the first case.

(9) Releasing the clamp on the hand-wheel shaft, draw up the rip-saw to the height required to cut the cheeks to the kerfs made in crosscutting. It is the part of wisdom to test a machine setting by means of a piece of scrap stock before running a piece of final stock thru. It is hardly possible otherwise to determine just how the saw or other tool will cut. (10) Adjust the ripping fence with reference to the proposed cheek on the face side, that is, so that the saw shall cut properly when the face side of the piece is next to the fence, Fig. 168. (11) Run the second end thru before laying this piece aside, provided this second end is tenoned as the first. (12) Reset the fence after all like parts have been run thru, so that the second kerf will cut properly when the face side is against the fence. (13) Run thru as before. It is a more economical way to keep a supply of steel washers on hand and an extra saw. Place both saws on the arbor with enough washers between to give the proper thickness of tenon. The set of the saws must be taken into account. If one wishes a $\frac{3}{8}$ " tenon he will have to separate the saws about $\frac{1}{2}$ ", the extra $\frac{1}{8}$ " being the amount of set on the two saws.

In cutting with the single saw, it is possible to work with other than the face side against the fence, in case the stock is sufficiently uniform to give the necessary



FIG. 168. SAWING TENON.

accuracy of tenon. The general rule is to keep face side or face edge against the fence or table top whenever possible, and to work from the same end of the stock as far as possible.

104. Cutting Wedges on a Circular Saw.—A great variety of work can be done on a circular saw involving some very difficult set-ups. Fig. 169 makes clear the manner of getting out wedges in large numbers easily.

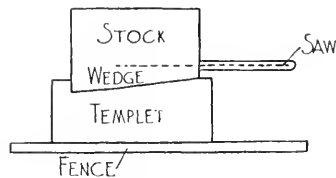

FIG. 169.
SAWING WEDGES.

105. Kerfing a Cove for Molding or Core-Box.—Fig. 170 shows one method of kerfing a core-box. The block is run over the saw successively, the saw being raised at

the various heights as shown by the kerfs. After such kerfing it is an easy matter to rout out the thin stock and finish the bottom of the curve smooth. A core-box plane, Fig. 81, would be used to give the final cuts.

A second method whereby the hollow may be approximately formed on the saw is as follows: (1) Draw a square which shall represent the saw table, Fig. 171. (2) Draw the line a-b which shall represent the saw position with reference to the table. (3) From the center o, on this

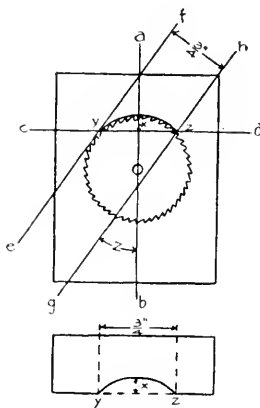

FIG. 171. CUTTING CORE BOX ON UNIVERSAL SAW TABLE.



FIG. 170. KERFING A CORE-BOX.

(4) From the top of the circle, which represents the cutting edge of the saw, measure down the distance x , the depth of the core-box groove. Draw the line c-d, which represents the top surface of the saw table, the segment above representing the cross-section of the core-box hollow or groove. (5) The points y and z locate themselves on the drawing. The distance between these points as represented on the saw table drawing is not, however, the distance between the same letters on the core-box drawing. It remains to lay off two parallel lines, as e-f and g-h which shall be apart the distance $y-z$ of the core-box, in this case $\frac{3}{4}$ ". The angle z so determined is the angle at which to set the ripping fence with reference to the saw. If

the machine at hand does not have an adjustable fence, the same result may be obtained by clamping a straight-edge in position, using hand clamps. (6) Lower the saw entirely below the table top. (7) Raise it about $\frac{1}{16}$ "

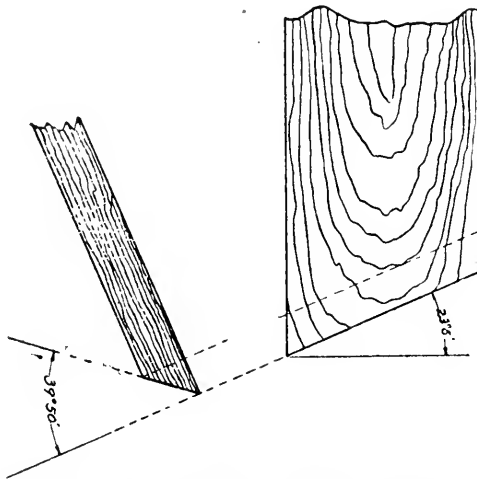
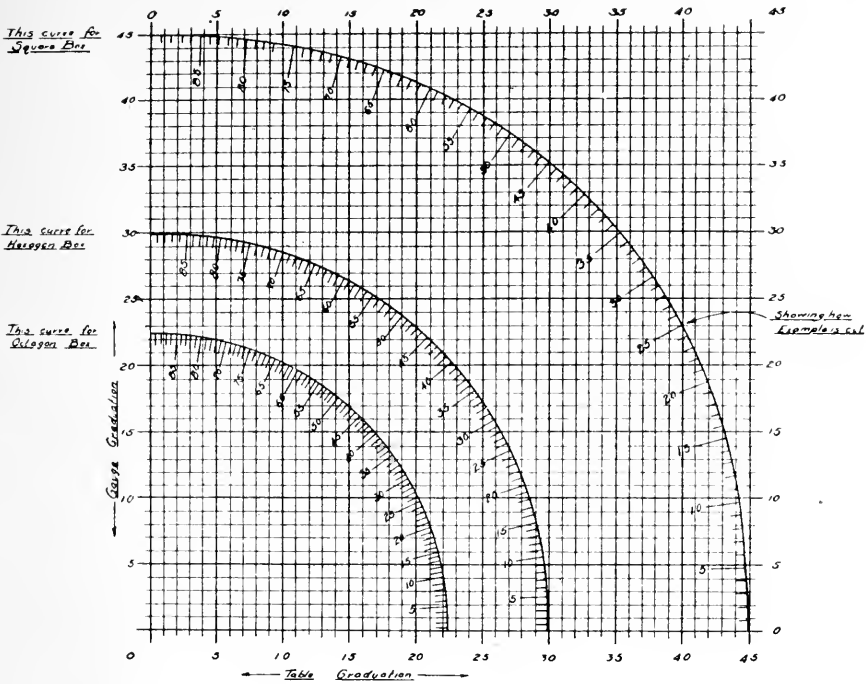

FIG. 172. TABLE TO DETERMINE SAW SETTING FOR CUTTING MITERS.

(By courtesy of the Oliver Machinery Co.)

above and run the core-box stock over, along the fence.
 (8) Raise the saw another $\frac{1}{16}$ " and run the piece thru. Continue in this manner until the space *x* is secured.

106. Table for Set-Up of Universal Saw for Compound Miters.—Fig. 172 illustrates a table for determining the saw setting for cutting miters for square, hexagonal and octagonal box sides, for the tilting saw table.

Example: To find how to set the table and cut-off gage to make a square box with the sides tilted 25° , first find the curve marked, "curve for square box." Follow along this curve until you find the mark 25. Then find how far to the right of the zero point this intersection marked 25 is and you will find it to be $39^\circ 59'$. It will be necessary to guess at the minutes. This means that the saw table must be tilted thru $39^\circ 59'$. Next note that the intersection is $23^\circ 5'$ above the zero point on the gage graduation line, which indicates that the gage should be set $23^\circ 5'$ from its normal position. This will produce the correct cut for the desired box or pyramid.

The same method applies to the hexagonal and octagonal boxes. The curves, altho having the general curve of a circle, are not true circles.

107. Grooving and Dado or Gaining Heads for Universal Saw.—Fig. 173 a, b, c, d, are examples of several types of heads which may be attached to a universal saw for use in cutting dados or grooves. In cutting grooves the ripping fence will be used while in cutting dados the cut-off fence will be made use of. The roller section of the top will be adjusted laterally to make room for the increased thickness of saw or head. Fig. 173-a is a grooving head which is simple in construction. It may be ground either straight or hollow, and may be obtained in sizes varying by $\frac{1}{16}$ ". Fig. 173-b illustrates a different

type of groover head. The body is cast iron and is furnished with pairs of knives of various widths. The scoring points serve to break the grain of the wood just ahead of the knife and thus produce a smooth cut on the sides of the groove. Fig. 173-c illustrates an expansion gaining head, very similar in principle to that just de-

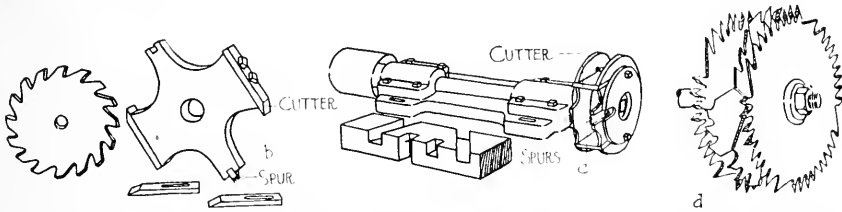

FIG. 173. GROOVING AND GAINING HEADS FOR UNIVERSAL SAW.

scribed. The outer faces carry the scoring spurs while the knives or cutters of appropriate width are clamped between. The outside collar is omitted when this cutter is used on the saw arbor, this cutter being intended for use on other machines as well. Fig. 173-d illustrates a popular type of groover head. It consists of two outside and three inside cutters and will cut grooves from $\frac{1}{8}$ " to $\frac{5}{8}$ " wide. Cuts may be varied by $\frac{1}{16}$ " or by $\frac{1}{8}$ ", the addition or omission of cutters making variations possible. This cutter will cut across the grain as well as along it. Note the shapes of the teeth.

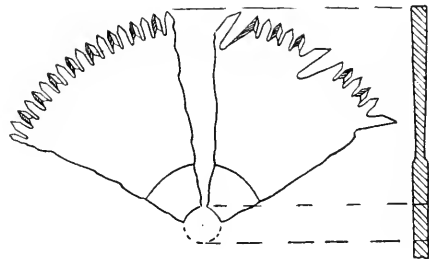

FIG. 174.

SECTIONS OF MITER SAWS.

108. Circular Miter Saws.—When it is necessary to secure very smooth surfaces, as in miter work, special saws are made use of. Fig. 174 shows two types of saws used for this purpose. These saws are not given any set, the taper grinding, as indicated in the cross-section being

sufficient to give clearance. The second type has a combination of teeth making it more suited for both ripping and crosscut sawing.

109. Fitting and Filing Circular Saws.—As the rip-saw is the easier to file, it is treated first, as a rule. The

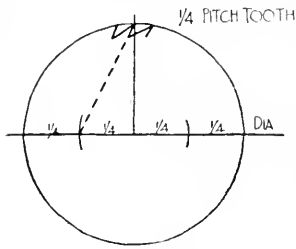

FIG. 175.

QUARTER-PITCH TOOTH.

file used is generally a 10", round-edge flat file. It is essential that a round edged file be used as the square edges cause sharp corners which may develop into cracks at the bottom of the gullet of the tooth. Most circular saws are filed at quarter pitch, that is, the bottom or cutting surface of the tooth is hooked back so that if a line indicating its direction were to be drawn across the saw, it would pass thru a point on the diameter of the saw $\frac{1}{4}$ the diametral distance from the edge, Fig. 175. This angle may be varied slightly, of course.

(1) Set the teeth by placing the saw on a setting stake, Fig. 176. The amount of set will be determined by the kind of work to be done. Familiarity with the fitting of hand- and rip-saws, which is taken for granted, should give one some idea as to the proper amount

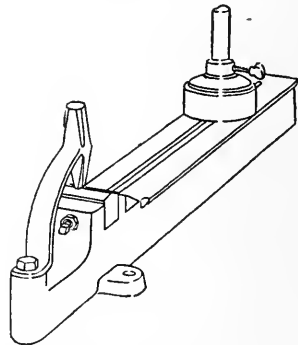

FIG. 176. SETTING STAKE FOR CIRCULAR SAWS.

here. After the saw is centered on the stake with the tooth hung over the anvil to give the desired set, the hammer hung on the spring is tapped with a machinist's hammer. The weight of the stroke must be determined by experiment. As in the hand-saws, it is the point of the tooth which is to be set rather than

the whole tooth to the gullet. (2) After about every third filing, a saw should be jointed. This consists in placing the saw on its arbor, or mandrel, with the teeth projecting very slightly above the table, causing it to



FIG. 177. JOINTING CIRCULAR SAW TEETH.

revolve at low speed, and then pushing a block of emery gently against the teeth, Fig. 177. Repeat until all the teeth project uniformly. (3) After a saw has been filed

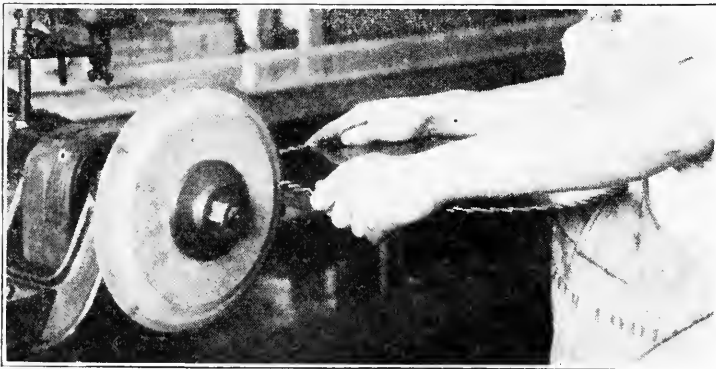

FIG. 178. GUMMING CIRCULAR SAW.

many times the teeth become too short to do their work well. The process of grinding out the gullets is called "gummyng." Gummyng is done by holding the saw successively against an emery-wheel of proper bevel, Fig. 178.

Care must be taken not to burn the saw teeth. A light touch against the emery, and that for a short interval, is all that is permissible at any one time. (4) The next operation is filing. Fig. 179 shows an adjustable circular filing vise.

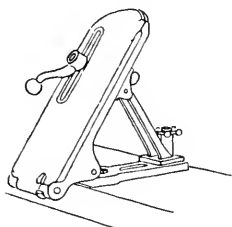

FIG. 179.

ADJUSTABLE CIR-
CULAR SAW FILING
VISE.

It should be adjusted to a vertical position for rip-saw filing. File the top of the tooth with the set pointing away from you until it comes to a point, holding the handle end just a little low, about five degrees to the horizontal plane thru the part being filed. Touch up the bottom of the tooth slightly with the file square across. File every other tooth in this manner, then reverse the saw and re-

peat on the remaining teeth.

The operations just described apply to the crosscut-saw as well, except the filing. In filing a crosscut-, circular saw an 8" or 10" three-cornered, or three-square, file

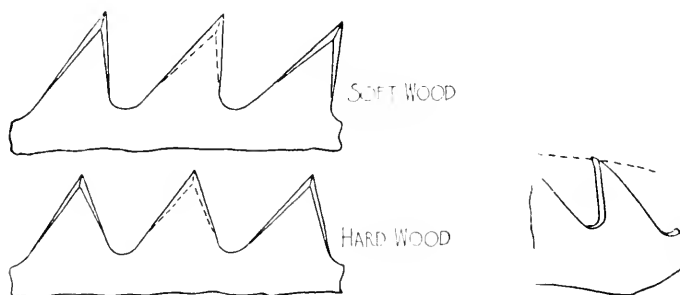

FIG. 180. CIRCULAR CROSSCUT AND RIP-SAW TEETH.

is used. The shape of tooth should be similar to that of a hand-saw for the same kind of work, and the result is secured by inclining the file similarly. Fig. 180 illustrates the shape of teeth advised.

110. **The Band-Saw.**—The band-saw is not a dangerous machine when properly guarded. Figs. 181 and 182 show a typical form of band-saw with parts named. While the adjustments may vary slightly, they are in the main, similar to those shown.

The saws used vary in size, the smaller being used for the cutting of small and sharp curves. The saw is placed on the two wheels. The upper wheel is adjustable vertically, so that saws of different lengths may be placed, and given the proper tension. Another adjustment makes possible the tilting of this wheel so that the blade shall "track" on the upper wheel. Once this is adjusted it seldom needs attention. The tables are usually so mounted that they may be inclined, an index showing the amount of inclination. An adjustable guide post counterbalanced by spring or weight, serves to guide the blade, yet allow it to move freely.

The main, or lower, shaft is usually constructed to be fed by felt wicks from an oil well just below, and will have a speed ordinarily of about 500 R. P. M. with a surface speed of saw of about 3,000' per minute.

111. **Operation of a Band-Saw.**—(1) Use as heavy a blade as the nature of the work will allow. (2) Make certain that everything is as it should be before starting

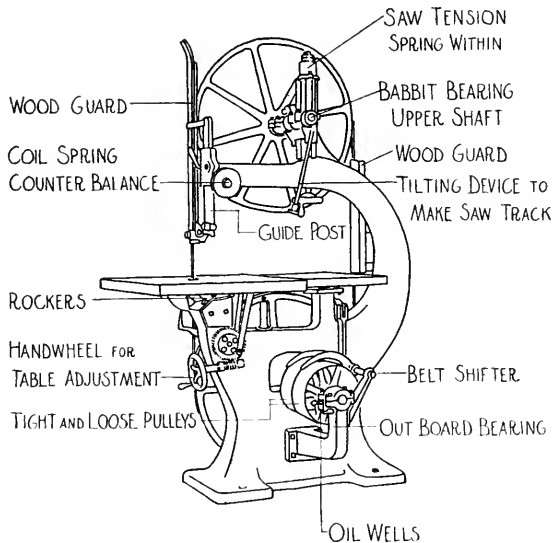

FIG. 181. BAND SAW.

the machine. Twirl the wheels to see that the saw runs in the guides, freely revolving the roller just after the work has been applied to the saw. (3) Adjust the guide-post so that the guides shall rest as close to the work as possible and the working line be kept visible. (4) Press the stock against the saw no faster than will give an easy cutting movement, and in cutting curves turn the stock with sufficient care that the saw may follow without

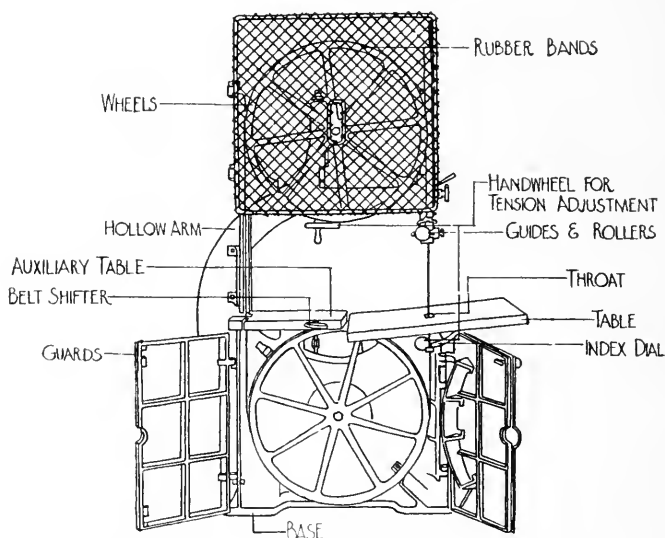

FIG. 182. BAND SAW WITH GUARDS.

being twisted. If a curve is so abrupt it cannot be sawed without continual "backing up" to secure a new kerf, either a narrowed saw is needed, or more set in the saw being used. The more set a saw has the easier it will allow the stock to be turned but the rougher the cut. In withdrawing stock in order to change the kerf, or for any other reason, the student must watch that he does not inadvertently draw the saw off the wheels. It is considered safer and easier, where one wishes to withdraw

stock from a band- or jig-saw before the saw has cut its way out, to turn the stock and cut out thru the waste,

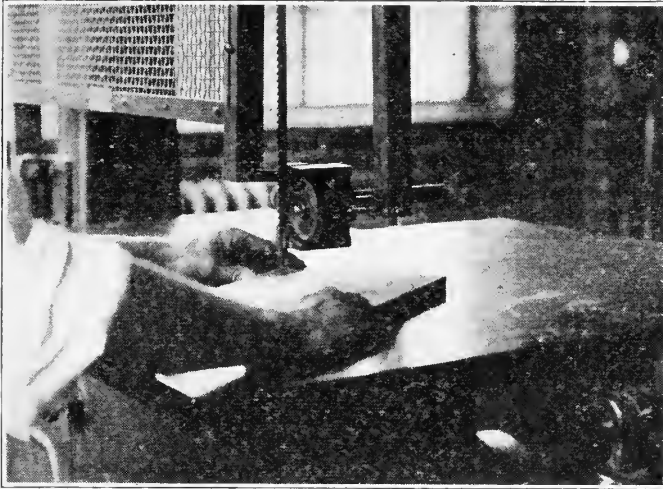

FIG. 183. CUTTING OUT.

rather than to try to withdraw the stock from the saw, Fig. 183. In this as in all other machinery the belt should be shifted slowly, giving the machine time to speed up. Some band-saws have ripping fences which may be attached to the table, Fig. 184.

112. Resawing Attachment for Band-Saw. Since stock is not sawed in thicknesses less than 1" at a mill, it becomes necessary when thinner

stock is wanted to resaw the thicker sizes. Fig. 185 shows a resawing attachment which may be fastened to the larger sizes of band-saws, the 36" size. Power feed

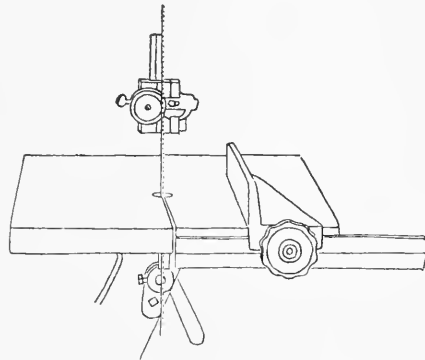

FIG. 184. RIPPING FENCE ON BAND-SAW.

is made possible thru a connection with the lower feed shaft of the band-saw. Stock 4" thick by 12" wide may be sawed with such an attachment at a rate of 12' per minute.

Where no resawing attachment is at hand, the following procedure may be adopted. In fact, it is a more satisfactory method than the other unless the band-saw is in excellent condition. Unless a band-saw is in excellent condition it will "run" in spite of the attachment:

(1) Suppose a 12" board or plank is to be resawed. Run it over the circular saw with the saw raised as high as it will go—perhaps 4". (2) Turn the board over and saw from the other edge leaving 4" of uncut stock at the middle. (3) Take the board to the band-saw and cut this part; the circular saw kerfs help to guide the blade of the band-saw.

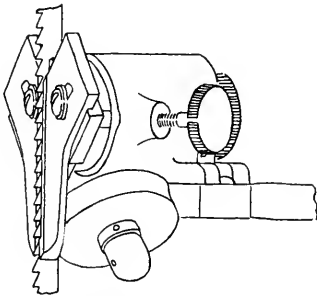

FIG. 186. BAND-SAW AND SAW GUIDES.

setting machine and a hand filing clamp. Outfits can be purchased in which all of the setting, filing and fitting are done automatically. This machine sets two teeth at a time. By the turning of the hand wheel two steel hammers are made to strike the teeth at the same time

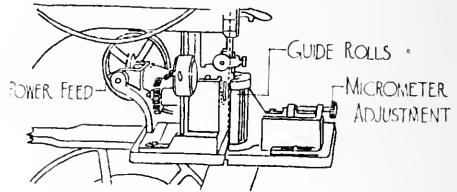

FIG. 185. RESAW ATTACHMENT FOR BAND-SAW.

113. Filing and Fitting a Band-Saw.—Fig. 186 shows the general shape of band-saw teeth, also their proper location with reference to the saw guides. Fig. 187 shows a filing and fitting outfit containing an automatic saw-

—one from one side, and the other from the other side. The face of the hammer can be adjusted to any desired radial position, so as to produce much or little set. As soon as the hammers have done their work on these two

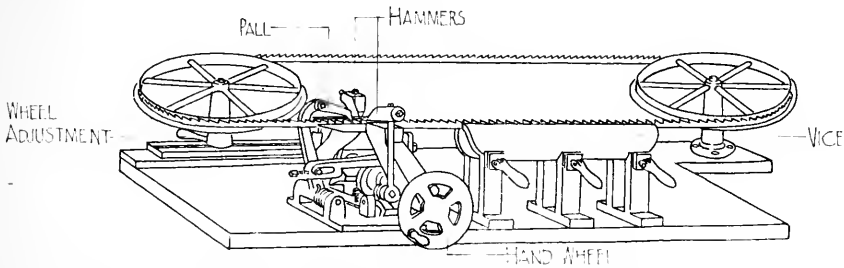

FIG. 187. AUTOMATIC BAND-SAW FILING AND FITTING OUTFIT.

teeth the pall automatically pushes forward into position two more teeth. The arm which feeds the saw can be adjusted to suit any number of teeth per inch. The frame is adjustable so that saws of different lengths may be placed upon it; the wheels may be adjusted vertically.

The filing vise is adjusted by three clamps. In filing, a 6" blunt band-saw file is used and the teeth are given somewhat more hook, or rake than hand-saws, with slight side angle so that the saw may cut readily both as a rip- and as a cross-cut-saw. All the filing is done from one side and the file must be held level or the saw will "run" to one side badly when in use.

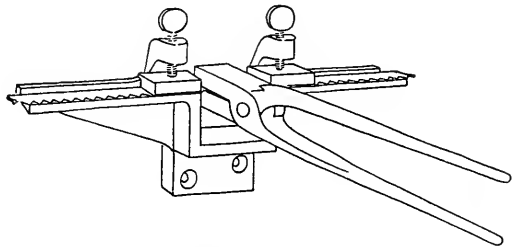

FIG. 188.
BRAZING CLAMP FOR BAND-SAWS.

114. Brazing Small Band-Saws.—When a band-saw breaks from any cause the broken ends must be united. This is called brazing.

Among the most common causes of breakage are feeding work too quickly, turning stock on the table faster than the saw can follow, forcing a dull saw, starting and stopping the machine with light blades suddenly and running a saw with a lumpy and improperly finished braze.

(1) By means of a file, scarf the broken parts to include one or two teeth; make the scarf no longer than necessary. For $\frac{1}{4}$ " to $\frac{5}{8}$ " saws take one tooth and for larger saws two teeth. (2) Place the parts in the clamp, Fig. 188, and adjust so that the edges line up properly

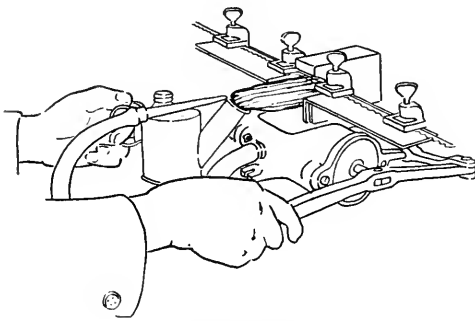

FIG. 189.

BRAZING WITH BLOW TORCH.

and the lap fits properly. (3) Place a thin coating of fresh borax paste on the scarfed parts for flux. (4) Cut and place between the scarfed parts a thin piece of silver solder of a size equal to that of the joint. (5) Heat a pair of tongs to a bright red. (6) Scrape off the scale from the jaws so that a good, flat bearing may be obtained. (7) Clamp the tongs to the scarfed parts as shown. The tongs should be held in place until the solder has melted thoroly, and until the color of the tongs has changed thru a dull red to a black. If the tongs are removed too soon the joint will chill before the solder has had time to set. When haste is necessary, two pairs of tongs may be used. The bright red ones being removed as soon as the solder has melted and these followed by a pair heated to a dull red.

Brazing is also done by means of the blow torch, Fig. 189. Brass solder or spelter may be used instead of

silver solder. Silver solder is more expensive. It comes in sheets. Brass spelter comes in odd shaped forms like shot. Place a small piece of brass solder on top of the joint and wrap a small flexible wire about the solder and joint. Over the whole put the borax paste flux. The flame from the torch is applied as in Fig. 189 until the solder has melted. Next file off the roughness and fit the teeth which need it.

115. The Scroll Saw.—The scroll or jig-saw, Fig. 190, is used for such curved sawing as requires inside cutting. To accomplish this a hole is bored thru the stock, the saw blade is released at its upper end and passed thru this hole and then fastened again to the tension strap.

Adjustable springs provide tension suited to blades of various sizes. A blower attached to the moving levers provides air to keep sawdust off the work so that the line may be easily seen. A foot lever makes possible the turning on and off of power and braking the momentum, with hands free for table work. The crank wheel will have a speed of about 825 to 1,000 R. P. M. One to 2 H. P. will be required to run the machine.

In using this machine the guides and stop must be carried as near the stock as possible. The saw must have its blade placed to cut on the downward stroke, teeth pointing downward.

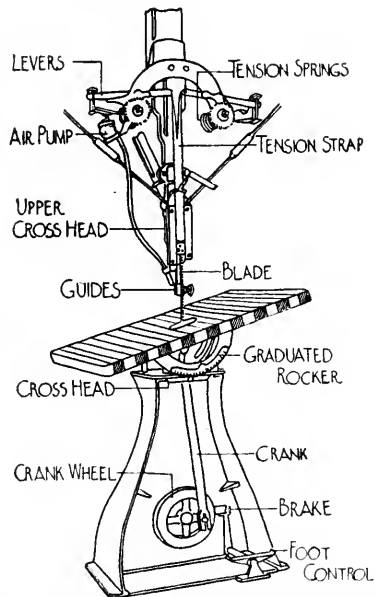

FIG. 190. SCROLL OR JIG-SAW.

116. **Boring Machine.**—Boring machines, Figs. 191 and 192, are made with either vertical or horizontal spindles, or with both. The machine shown in Fig. 191 is a vertical spindle machine with either hand or foot control. The table is adjustable so that holes may be bored at any angle with reference to the surface of the stock. This table is adjustable vertically by means of the hand wheel. By means of step cones, three speeds

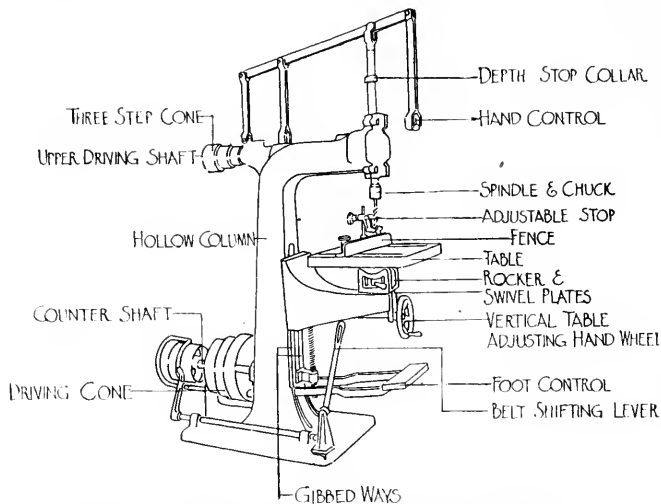

FIG. 191. VERTICAL SPINDLE BORING MACHINE.

are obtainable, the greatest for use with small bits, etc. Speeds of spindle on this machine are 1,750, 2,240 and 3,000 R. P. M. Two H. P. is required.

The fence may be adjusted to any position on the table, and is provided with a stop which prevents the stock from being lifted from the table when the bit is allowed to raise.

These machines are usually provided with a set of bits, five in number, varying from $\frac{1}{4}$ " to $\frac{3}{4}$ ". Fig. 193 shows three other tools which may be used in this machine. The first, a fillet cutter, is used by pattern-makers in forming fillets on patterns. Fig. 193-b is a core-box

cutter and will be found exceedingly helpful in cutting any type of core-box, straight or curved. Fig. 193-c is to be used in routing flat grooves, either straight or curved, such as stair stringer gains, etc. These cutters may be had in sizes ranging from $\frac{1}{8}$ " to 2", or 3" in the case of core-box cutters.

117. Operation of a Boring Machine.—(1) Set a bit

of the required size in the chuck, turning the spindle to see that the spur centers properly. (2) Adjust the belt for speed, slow speed for large diameter of bit, etc.

(3) Adjust the table to the angle required and set the fence so that the bit may center on the stock properly. (4) Adjust the table vertically to an approximate position. (5) Set the depth stop for the depth of hole required. An easy way to do this is to place the stock on the table and draw the bit down, by means of the foot control, along side the end of stock, an amount required to give the depth as indicated by a mark previously made on the end of the stock by rule and pencil. With the bit so held, adjust the depth stop. (6) Power to move the spindle vertically may be applied by hand or foot.

(6) Power to move the spindle vertically may be applied by hand or foot.

(6) Power to move the spindle vertically may be applied by hand or foot.

(6) Power to move the spindle vertically may be applied by hand or foot.

(6) Power to move the spindle vertically may be applied by hand or foot.

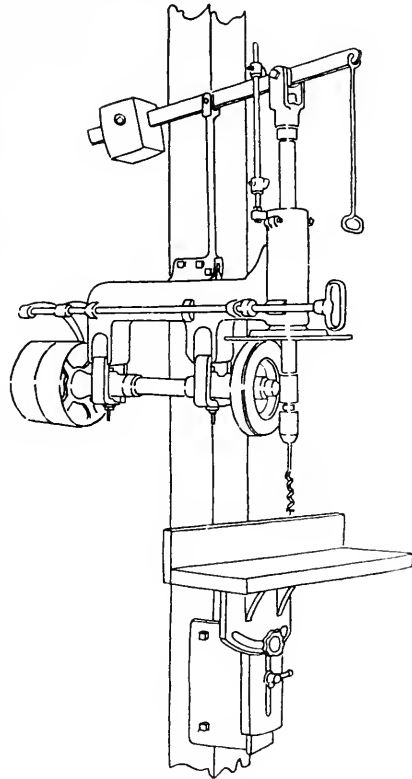

FIG. 192.

POST BORING MACHINE.

118. Mortiser.—The hollow chisel mortiser, Fig. 194, is a machine in which the cutting mechanism is a bit with

especially designed lips which project below and just beyond the edges of a hollow chisel. The bit clears the way, the chisel following closely and forming square corners. By moving the stock along the fence and making successive insertions of the bit and chisel, a mortise of any desired length may be completely formed. This machine is not dangerous but it requires thoughtful setting up that it may not be damaged. Chisels of various sizes are furnished.

Three H. P. is required, and the countershaft runs with a speed of 900 R. P. M., giving the bit a speed of 3,500 to 4,000 R. P. M.

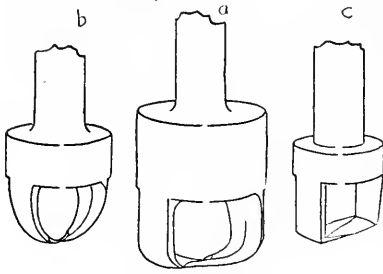

FIG. 193.

A—FILLET CUTTER.

B—CORE-BOX CUTTER.

C—FLAT GROOVER.

Balanced pulleys make possible a transfer of power from a horizontal countershaft to a vertical spindle. These pulleys run on adjustable shafts.

In setting up this machine, (1) the proper bit and corresponding chisel are selected along with the proper bushings.

(2) The spindle is revolved until the set-screw at x can be reached with a wrench provided for that purpose. (3) The set-screw is withdrawn sufficiently to allow the bushing of bit to enter the boring mandrel. At the same time the bushing of the chisel is inserted in the chisel mandrel. A screwdriver may be used to assist in working the parts to position. By placing bushing, chisel and bit in position, one with reference to another, before insertion, adjustments may be easier made. The set-screw at x must pass thru the boring bushing and rest firmly against the flatted part of the bit shank. Beginners frequently fail to enter the set-screw properly, resulting

in a damaged bushing, or, if the screw fails to rest upon the flatted shank of the bit, in a failure of the bit to bore. (4) The chisel is held in place by the set-screw at y. (5) To set the chisel square, the fence may be drawn forward until it rests against the chisel. A trial upon a piece of scrap stock will indicate further necessary adjustments. The cutting lips of bit should not be forced against the

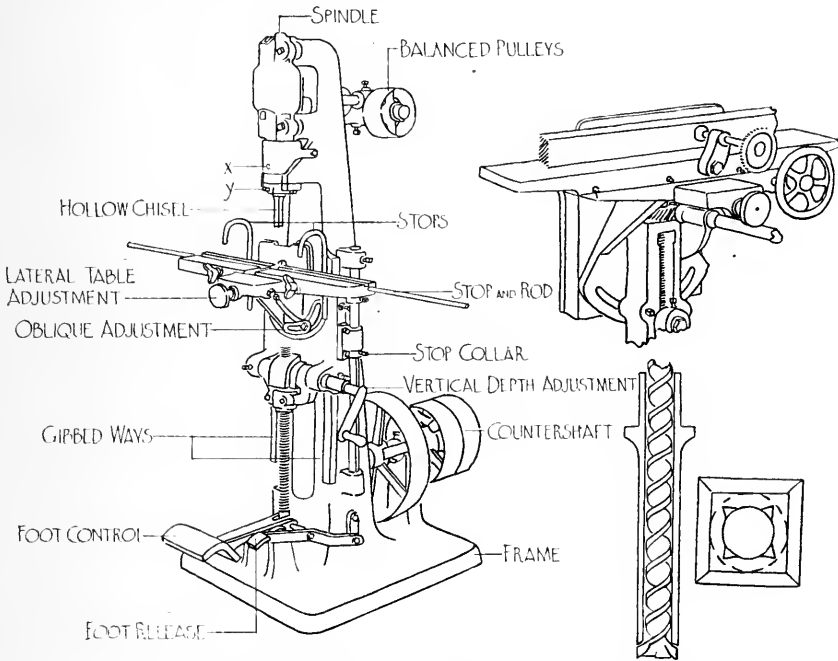

FIG. 194. VERTICAL HOLLOW CHISEL MORTISER.

chisel edges in the set-up, but a space of $\frac{1}{32}$ " to $\frac{1}{16}$ " should be allowed that the bit may not be pressed against the chisel causing it to heat.

119. Operation of Hollow Chisel Mortiser.—With the chisel of proper size in place, (1) lay off on the end of the stock, or on a piece of scrap of the same size, the depth of mortise wanted. (2) With the foot push the pedal to the floor and hold it there. (3) With the crank at the right of the machine, raise or lower the table until

it has the position it should have when the chisel is at the bottom of the mortise, as indicated by the marking on the end of the stock placed against the chisel. (4) Adjust the vertical stop at the right of the machine so that the table may not drop any lower than is required to free the chisel from the mortise safely. (5) By means

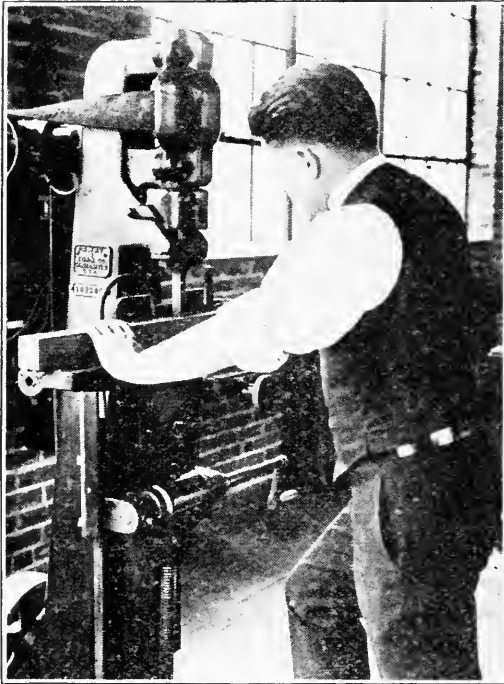

FIG. 195. OPERATING VERTICAL HOLLOW CHISEL MORTISER.

of the lateral adjustment, set the table to give the proper lateral mortise location. Remember that the face side or face edge of the stock to be worked is to rest against the fence. (6) Adjust the stops which keep the stock from being raised from the table, and the stops which determine length position, if these are needed.

In operating, push the foot control to the floor, Fig. 195.

If the weight of the table is not sufficient to release the chisel, a touch on the foot release will be sufficient.

In removing the bit, always return the set screw that it may not be broken off thru someone's carelessly turning on of the power.

The compound table, Fig. 194 (inserted cut), differs from the plain table in that the stock is clamped to the

table, and table and stock are rolled along from side to side for successive cuttings by means of a handwheel.

120. Tenoner.—A tenoner, Fig. 196, is a machine which, because of its dangers to the operator and the fact that most school tenoning may be done with sufficient rapidity on the circular saw, is little used in manual training shops. That the student may know the possibilities of such a machine, a drawing of that machine

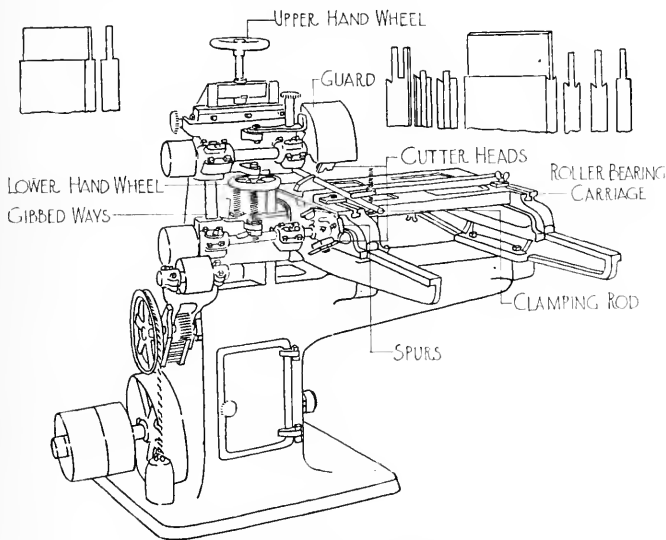

FIG. 196. TENONING MACHINE.

is shown herewith. Its use is not recommended except where much duplicate work is required. The machine is quite complicated and must be set up with accuracy or the results will be unsatisfactory. It has two heads, one below the other, with the stock moving between on a roller-bearing carriage. On these heads are bolted two or four cutters or knives. Spur cutters to score the wood ahead of the knives are bolted to these heads as shown.

The stock to be tenoned is laid on the table or carriage and clamped down by the rod as shown in the illustration.

The carriage is pushed forward carrying the stock between the cutter heads. The spurs precede the knives and form the shoulders of the tenon. The knives on the heads take off the material from the sides or cheeks of the tenon. These two heads run in opposite directions.

There is also a small vertical head farther back on the machine. This is called a cope head. If the shoulder of a tenon is not to stand at right angles to the face side, or if it must be cut or coped to fit a molding on another member, this head is used. The cutting of tenons for common house doors illustrates the use of the coping

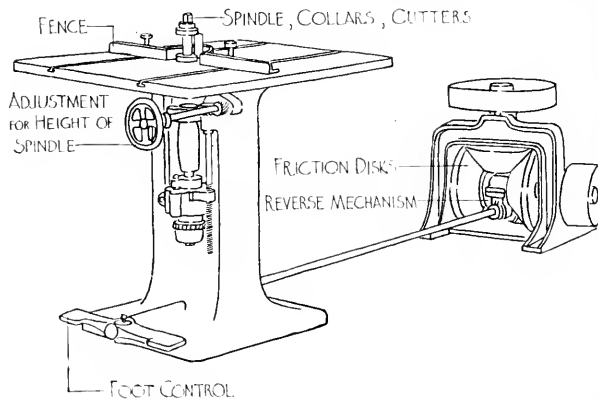

FIG. 197. SHAPER.

head of the tenoning machine. Tenoners, like most other woodworking machines, are made in many different styles. They may have one or two main cutter heads, with one or two cope heads or without either. They may be constructed to cut tenons on both ends at the same time.

The cutters are bolted on the heads so that they shall stand out at about 40° to the side of the head so as to produce as much of a shear cut as possible. The upper spindle frame has lateral adjustment for the purpose of making shoulders of tenon out of line if desired. Both

cutter heads may be adjusted up or down at the same time by means of the upper handwheel. The lower handwheel adjusts the distance between the heads.

Two H. P. is required to run such a machine and the speed of the main countershaft is 950 R. P. M., with cope head running at 1,266 R. P. M.

121. The Shaper.—The shaper, Fig. 197, is considered the most dangerous of all woodworking machines and should not be operated except by a careful, competent person who has been taught its dangers as well as its possibilities.

The machine consists of one or two vertical spindles over each of which two collars are placed. These two collars have in their flat sides V-shaped grooves, Fig. 198, into which pieces of steel are placed which have been ground to the shape or form of the cut which is to be made. The angle included in this V-shape in the collars is 60° , this having been adopted as standard.

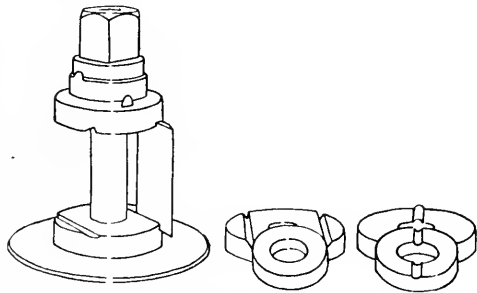

FIG. 198.
SHAPER COLLARS AND CUTTERS.

The shaper is a very high speed machine the spindle running from 4,500 to 6,500 R. P. M. Two H. P. is ordinarily required.

Fig. 197 is an example of a single-spindle machine. The double-spindle machines have two spindles made to revolve in opposite directions so that the operator may quickly change from one to the other as the change in the directions of the grain of the wood he is working requires. This is quite a convenience in collar work. Single-spindle shapers are made with a reversing of

spindle, accomplished by a peculiar form of friction countershaft as shown in the illustration. By means of a foot control the operator can throw the driving shaft against one or the other of the disks which will cause the shaft to revolve in opposite directions. The handwheel makes possible the raising or lowering of the spindle mechanism as desired.

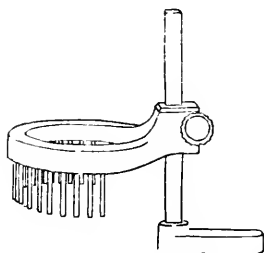

FIG. 199.
SHAPER GUARD.

A shaper, of all machines, should be run with a guard, even by the most competent workman. Among the various guards made for shapers is the one shown in Fig. 199.

122. **The Lathe.**—The size of a speed lathe is determined by the largest diameter of the stock it will turn

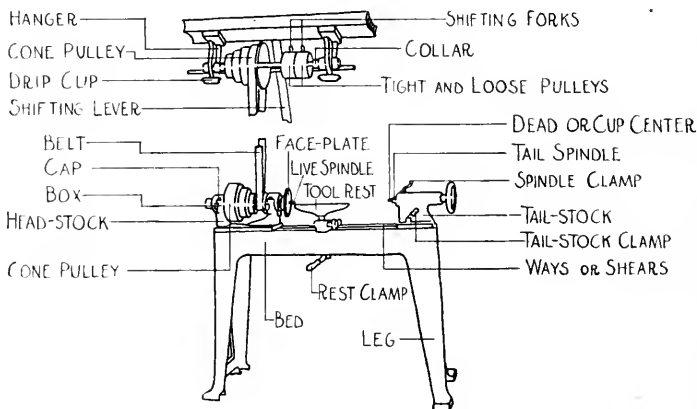

FIG. 200. LATHE—COUNTERSHAFT OVERHEAD.

and the maximum length between centers. Lathes are constructed in a number of different forms. Some have the countershaft overhead, Fig. 200; others have it under, and a part of, the lathe, Fig. 201; while others are motor

driven either from the headstock, Fig. 202, or from a bracket below it. The various parts and their relative positions are shown in Fig. 200. The headstock on most all lathes supports a hollow spindle—live spindle, so called, because it revolves. A rod is inserted thru this hollow when it is desired to knock out the live or spur center, that a face-plate may be attached, or for any other reason. The bearings on all first-class lathes are constructed to adjust to take up wear, the device differing somewhat upon different lathes. The tail spindle supports the dead center or cup center. A detailed description of the manner of placing stock in the lathe is to be

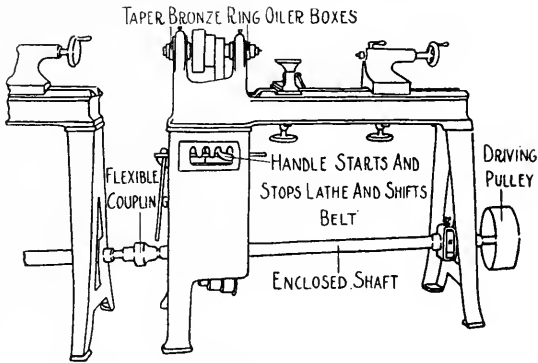

FIG. 201. UNDER DRIVEN LATHE.

found in the chapter on Wood-Turning.

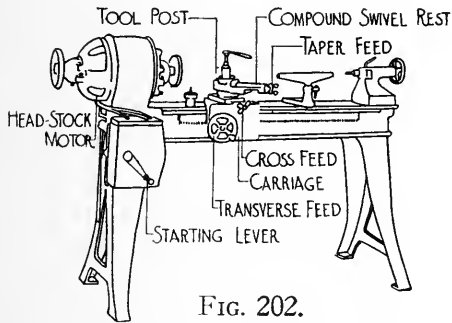

FIG. 202.
MOTOR HEAD DRIVEN LATHE.

The countershaft of a lathe will run at 500 to 700 R. P. M., giving a lathe speed of 700 to 3,000 R. P. M., depending upon the size of the lathe. The 10" or 12" lathe will usually have variations from 700 to 3,000 R. P. M. The proper speeds to use are explained in the chapter on Wood-Turning.

Lathes in constant use should be oiled every day by each user. Adjustments of parts to prevent heating or to take up end play should be made only with permission

of the instructor, who will inspect such adjustments before power is applied. These cautions apply to beginners. The lathe is usually the first machine a beginner is permitted to use.

123. **Sanders.**—The sanding machine is not often found in any but trade schools and manufacturing shops. It is made in several different forms, as drum, belt, disc and spindle sanders. Sometimes a sander is composed of several of these forms.

The drum sander, Fig. 203, is a very complicated

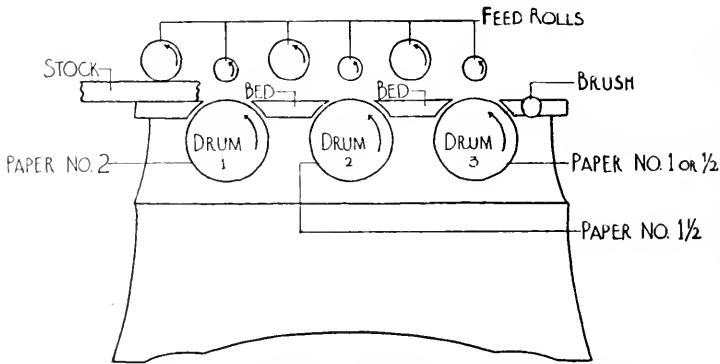

FIG. 203. SECTIONAL VIEW OF DRUM SANDER.

machine and is suited to flat work where large quantities of stock must be handled.

The sandpaper on such a machine is arranged on three horizontal drums about 12 inches in diameter, suspended below the bed of the machine somewhat after the fashion of the jointer head. Above the bed is a system of feed rolls which may be raised or lowered to take in stock of different thicknesses. As the stock enters, it comes in contact with drum No. 1. This drum carries No. 2 sandpaper. This paper, being coarse, grinds off the roughness very fast but leaves a scratched surface. Next comes drum No. 2 which carries No. 1½ paper. This leaves the

surface a little smoother but still not suited for final finish. Drum No. 3 carries No. 1, or finer, sandpaper which polishes off all the scratches and leaves the surface ready for the application of a finish. As the stock leaves the machine small rotary brushes remove all dust and particles of sand which may have collected.

The three drums are so arranged as to oscillate, move endwise, about $\frac{3}{4}$ " each, assisting still further to produce a smooth surface, by preventing scratches on cross rails of stock.

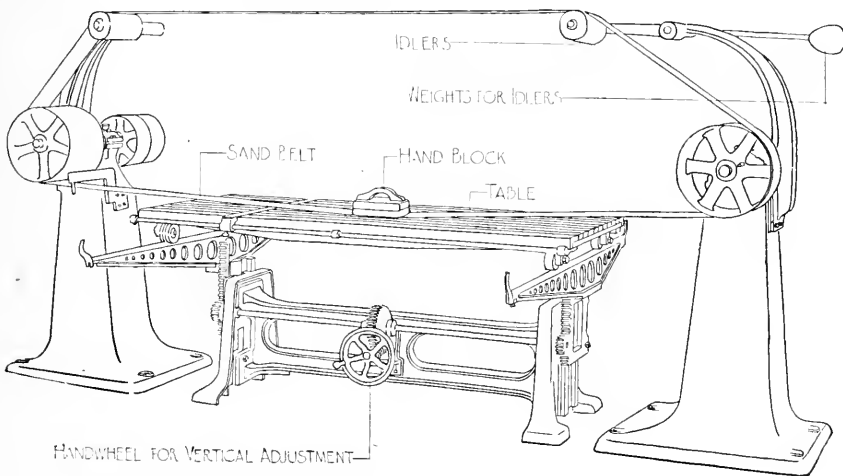
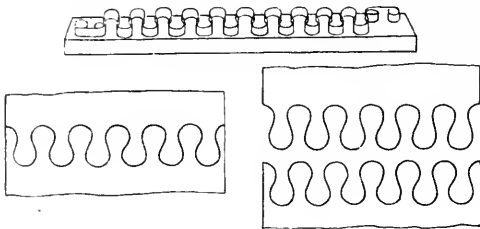

FIG. 204. BELT SANDER.

The drums should run at 800 R. P. M. on an average size of machine and will require from 6 to 15 H. P.

124. The Belt Sander.—Belt sanders are made in a variety of forms. Fig. 204 illustrates one type. It consists of two pulleys arranged at any desired distance apart which carry the sanded belt. Weighted idler pulleys make possible the drawing down of the sanded belt. Below the belt is a table adjustable vertically. This table top also moves transversely. Stock is placed upon this table and the sanded belt is pressed against it by means of the hand block.

Belts for such machines are made of canvas upon which the sand is placed in the process of manufacture. It is known as garnet cloth, and comes in rolls 150' long by 14" or 28" wide. This cloth may be ripped to any desired length or width.



The speed of such a belt is generally about 2,200 feet per minute. Little power is required to run such a machine, not over 2 H. P.

FIG. 205. BELT SPLICING DIE FOR SANDER. The student should understand that such machines as this are not intended as planers. They are for final smoothing just as is hand sandpapering.

The belt for a sanding machine may be lapped and glued to make it continuous, or it may be joined by means

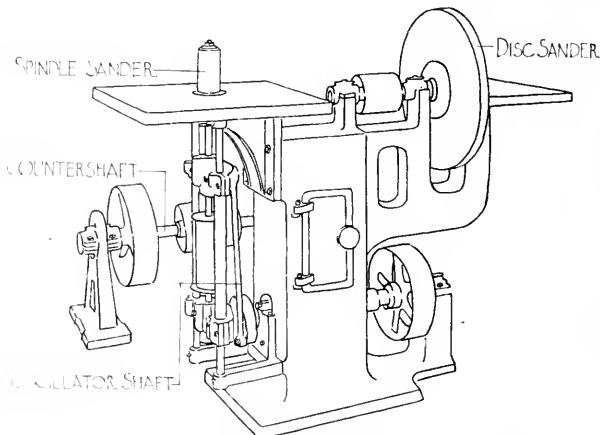

FIG. 206. SPINDLE AND DISC SANDER.

of a joint made with a belt splicing die as shown in Fig. 205. When lapped and glued the sand should be removed from the inner half of the lap about $1\frac{1}{2}$ " by means of hot water. Clamps applied as in gluing a leather belt will hold the parts.

125. Disc and Spindle Sander.—Fig. 206 illustrates one of the many types of disc or spindle sanders. Irregular work is sanded upon such machines, spindles of several sizes being provided to suit the curvature of the work. The disc is made of glued-up hardwood strips and covered with heavy Brussels carpet. A wrought-iron band around the edge holds the paper to the disc. The vertical spindle has an oscillating movement vertically to give smooth work and bring all the paper in contact with the work. The disc will run at about 700 R. P. M. and the spindle at 1,200 R. P. M. The table of the disc is adjustable so that beveled work may be sanded. Two H. P. is required.

126. The Trimmer.—The trimmer is one of that class of mechanical contrivances which stands midway between the bench tool and the power machine. Fig. 207 shows a popular style of trimmer. This tool is used mainly by pattern-makers.

Beginners are inclined to abuse this machine by taking cuts too heavy for the mechanism. If hard wood is being cut there should never be taken off more than $\frac{1}{16}$ " at a time, and in soft wood not more than $\frac{1}{8}$ ". To take more is to endanger the adjustment of the machine.

To do good work a trimmer must be kept perfectly sharp. As trimmer knives are tempered very hard, care must be taken in the grinding that the temper shall not

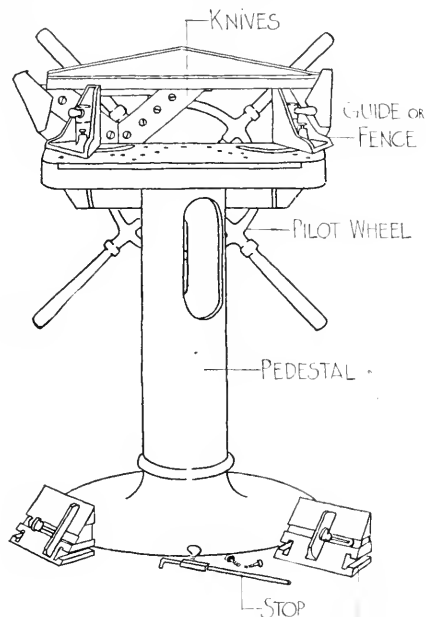

TRIANGULAR ATTACHMENT—
FIG. 207. TRIMMER.

be drawn. If the temper should be drawn it will be necessary to grind until the softened part is removed. It is extremely essential that the face of the knife shall not

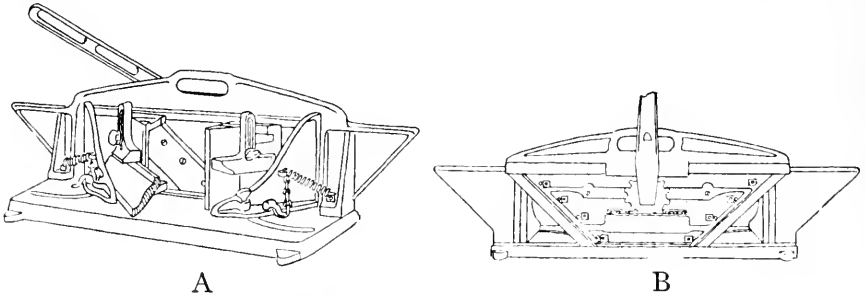

FIG. 208. BENCH TRIMMER.

be beveled. The success of a trimmer depends upon the close cutting of the face of the knife edge. Any bevel

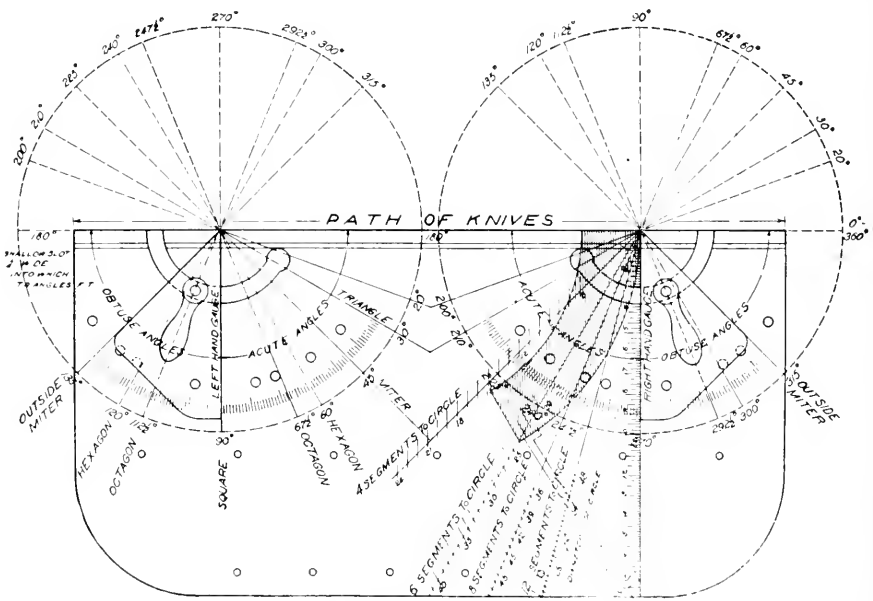

FIG. 209. TRIMMER TABLE.

whatsoever would tend to push the knife away from the stock. The face of a knife is ground slightly concave, about $2/1000''$. All the grinding and oilstoning or honing

must be done on the bevel side. In removing the wire edge the face side may be touched with a fine, hard, flat stone just enough to remove the wire edge. The final stroke in honing should be taken from the bevel side as this tends to leave the edge shaped toward the stock to be cut, which produces better results.

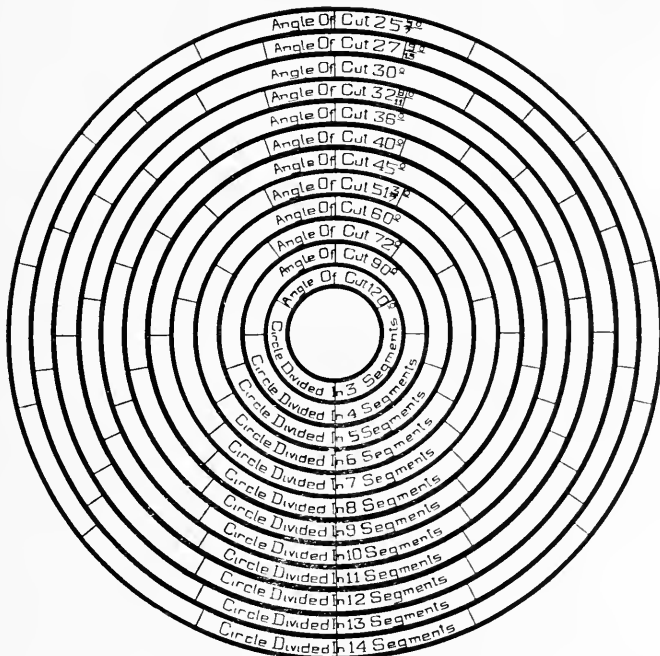

FIG. 210. TABLE FOR SEGMENTAL WORK WITH TRIMMER.

Fig. 209 shows a trimmer table ingeniously laid off to assist in segmental work. Two gages are given so that both halves of the circle may be attended to. All degrees between the knife line and the lines marked right and left gage lines are for acute angles, those beyond the gage lines are for obtuse angles. A little study of the cut will indicate its use. The shaded part represents a segment of a 24" circle set to trim one of 6 segments. Figs. 210, 211, 212 are devices furnished by the manu-

facturers of the Oliver trimmers to aid the workman in segmental work. They are self-explanatory.

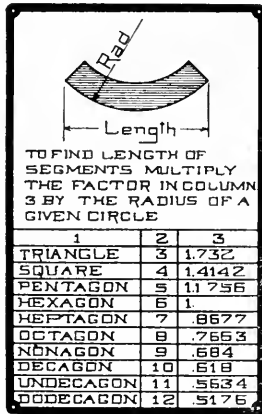

FIG. 211. TABLE FOR SEGMENTAL WORK ON TRIMMER.

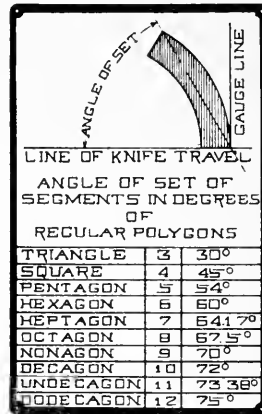

FIG. 212. TABLE FOR SEGMENTAL WORK ON TRIMMER.

127. Miter Plane and Chute Board.—Fig. 213 illustrates a machine tool which serves a purpose similar to that of the trimmer. A plane with its iron set askew is made to travel a path along a base. An adjustment makes possible the presenting of small stock at any desired angle with reference to this path.

128. Miter-Box. In Fig. 214 is illustrated a miter-box of improved type. The saw may be set at any angle desired. Its use is obvious.

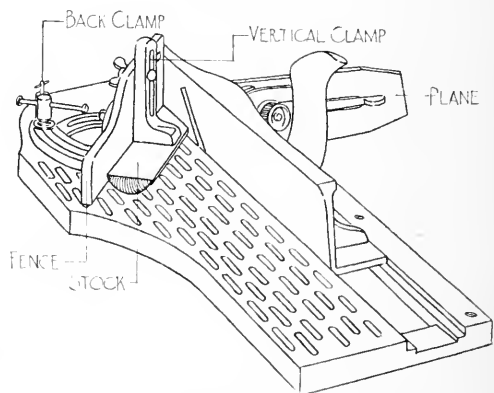

FIG. 213. MITER PLANE AND CHUTE BOARD.

129. Picture Frame Miter-Box and Nailing Clamp.—

By means of a machine tool like that shown in Fig. 215, picture frame making becomes simple. Two clamps are attached to a piece of molding and the miters cut. After miters are cut, these clamps will hold the stock firmly while the saw is run thru the kerf to make a "sawed fit." When a fit is secured the frame is revolved as in Fig. 215-b, and the joint fastened by boring and nailing.

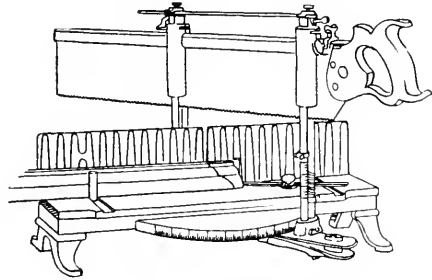

FIG. 214. MITER BOX.

130. Automatic Grinder.

—Where planer, jointer, or trimmer knives are to be sharpened, an automatic holding and feeding device of some kind is necessary. Fig. 216 shows an attachment known as a hand feed, which may be attached to a grindstone. The knife is set in this feed and moved back and forth across the stone by means of the handwheel.

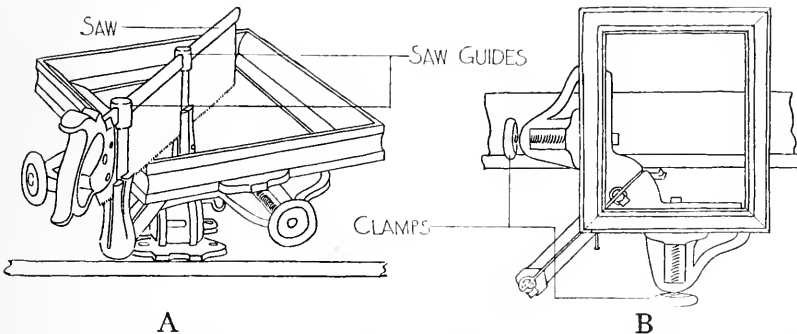

FIG. 215. PICTURE FRAME MITER BOX AND NAILING CLAMP.

Fig. 217 shows an automatic knife grinder which may be set to take a certain depth of cut. When this depth is secured the machine stops cutting. The mechanism is such that the carriage reverses its direction auto-

matically at the end of each stroke. The machine will grind either straight or hollow edge.

The knife should be set and the holder adjusted so as to secure the angle of bevel desired; an index is provided on the knife holder. The stops then should be set so

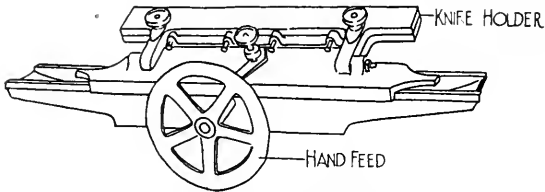

FIG. 216. AUTOMATIC HOLDING AND FEEDING DEVICE.

that the carriage shall carry the knife almost but not quite off the stone at each direction of travel.

The emery wheel is cup-shaped and has a spindle speed of 1,500 R. P. M. The speed of the feed to the knife frame carriage is $23\frac{1}{2}$ feet per minute, approximately.

131. The Grindstone.—A good grindstone, Fig. 218, should be a part of every shop where beginners are. A stone with coarse grit should be selected.

When a stone becomes smooth or shiny from use it

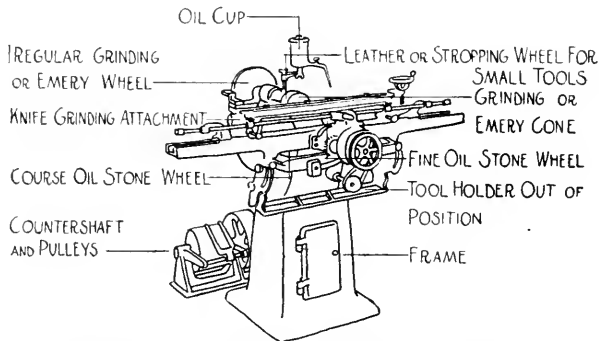

FIG. 217. AUTOMATIC KNIFE GRINDER.

may be put in shape again by cutting off this glaze by holding to its surface a piece of coarse sand stone, a piece of emery wheel, or by holding and rolling the end of a piece of gas pipe against it. A 3' stone, 6" thick is none too large for a good-sized shop. A stone should

be run as fast as is possible and not throw water. A 3' stone may be run 65 R. P. M., or at a surface speed of about 600 feet per minute. Arrangements should be made to flow plenty of water on a stone.

132. Power Transmission.—Leather belting represents the primitive as well as the most common method of power transmission.

The success of a shop depends greatly upon the care and upkeep of the belts. If they are neglected and allowed to become dry and loose they will not transmit the power properly. If they are not properly spliced or laid they will make an annoying pound as the joint passes over the pulley. This not only sounds bad but is hard upon the bearings and causes a loss of power as well.

There are several kinds of belting but the best for the wood shop is leather. Woven belts, or canvas belts

covered with rubber, used upon threshing machines are harsh and do not cling to the pulleys as do leather belts. They are cheaper than leather belting.

Leather belting should be kept pliable by an occasional application of neat's foot oil. Mineral oils must be avoided as they rot leather. Before applying the neat's foot oil, see that the belt is clean; a cloth dampened with kerosene may be of assistance. Apply a light coating of oil to each side of the belt and allow this to work its way

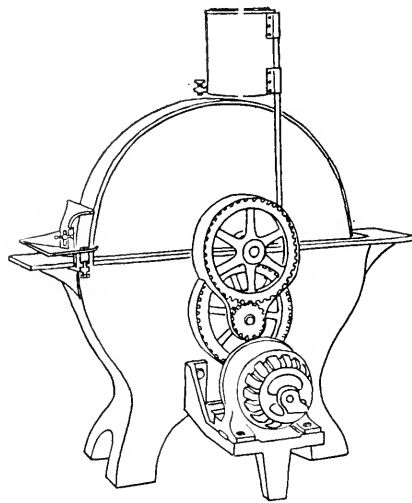

FIG. 218.
MOTOR DRIVEN GRINDSTONE.

into the belt before a second is applied. Repeat the oiling until the leather is mellow and soft.

Avoid the use to excess of sticky belt dressings. They cause the belt to cling to the pulley, often-times with such force as to pull off the grain side of the belt, as well as interfere with free transmission of power. An occasional application may be made where immediate clinging of belt is required.

Belts which have become saturated with grease or mineral oils, such as machine oil, must be cleansed by washing with naphtha.



FIG. 219. BELT HOOKS.

133. **Splicing Belts.**—There are a number of ways to splice a belt. Belt hooks may be used to advantage upon cheap rubber belts such as are used upon farm machinery, Fig. 219. Such fastenings are not to be recommended for shop use.

A whang or rawhide lacing may be used where the

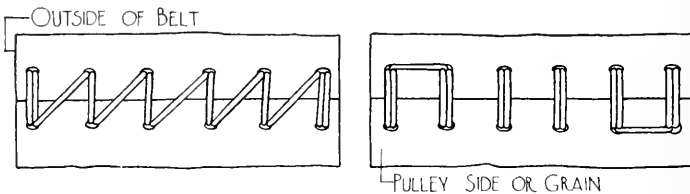

FIG. 220. WIRE LACING.

belt is to be run at a low speed. The “pounding” upon high speed machines, made by the lacing is not desirable.

Wire lacing, Fig. 220, is often used upon woodworking machines. This makes a satisfactory splice and is fairly noiseless. This wire comes in three sizes determined by the size of the belt. It is quite flexible and will stand a great amount of wear upon pulleys of fair diameters. On

small pulleys, such as lathe pulleys, it has a tendency to break, making it quite dangerous to shift such belts by hand. Directions for applying wire lacing will be found upon the box in which the wire is bought. Belt splicing machines can be got which will apply wire lacings very quickly.

The endless or glued belts are considered the most satisfactory and are used upon high-speed machines because the splice is noiseless.



FIG. 221. BELT SPLICES.

There are two kinds of endless belt splices. The single-

ply splice, Fig. 221-a, is used where the belt is composed of a single thickness of leather. The double-ply splice is to be used upon double belts, Fig. 221-b.

To prepare a single belt for splicing, (1) tack it to a board and with a smoothing plane taper the ends as shown. The taper should be about as long as the belt is wide. Professional belt men have special tools for

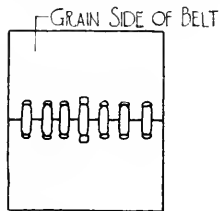

FIG. 222. STRAIGHT STITCH BELT LACE.

this work but they are not a necessity, the plane serving very well indeed. (2) When the ends have been prepared, place the belt alongside a straight-edge so that the edge of the belt may be kept straight. (3) Apply good hot glue, but not boiling, just as if gluing wood. The glue should not be too thick. (4) Turn the laps together and with the face of the hammer work out from

the joint all the glue possible. (5) Place a block of wood on the joint and apply a hand clamp to hold the belt between the block and the board on which the belt is resting. Special belt glues are prepared for belting purposes but the ordinary cabinet glue gives satisfactory service. Large belts must be glued a small portion at a time. Chilled glue is of no value.

Single belts should be put on so that the grain or hair side will run next the pulleys, and so the points of the lap will run against the pulleys. The lap on the outside

Punch Nos.	Diam. of Hole	Recom'd Width of Lace	Width of Belt	Weight of Lace
6	11/64"	1/4"	} Up to 5"	Light
7	3/16"			
8	1/4"	5/16"		
9	9/32"	3/8"	} 6" to 14"	Light
10	5/16"	7/16"		Medium
11	3/8"	1/2"		Heavy
12	13/32"	5/8" & 3/4"	14" & over	Heavy

Some beltmen use but two sizes (No. 9 and No. 11) of punches for all widths of laces; that is, one hole in punched and the punch is then offset to cut the first round hole into an oval hole. The longest way of the oval hole is cut parallel with the edge (not the end) of the belt. Do not use a punch larger than necessary to draw in the lace.

FIG. 223.

of the belt is most likely to come loose if run against the air pressure. Double belts should be placed so that the points of the lap will run with the pulleys, since both sides will then not be affected by air resistance.

There are a number of ways to lace a belt. Fig. 222 shows one style known as the straight stitch lace. (1) Cut the ends of the belt to be laced square to the edge, using a try-square. (2) Punch a row of holes in each end exactly opposite each other and 1/2" from the edge

with $\frac{3}{4}$ " between centers. Begin to lay out for the holes at the middle of the belt width.

Belt lacings are put up in bundles containing 100' of lacings, varying in width by 16ths from $\frac{1}{4}$ " to $\frac{1}{2}$ ", inclusive, with additional widths of $\frac{5}{8}$ " and $\frac{3}{4}$ ". Such lacings are very strong and are made from imported India cowhide or from the best native hides. Lacings $\frac{1}{4}$ " to $\frac{5}{16}$ " are known as light-weight, $\frac{3}{8}$ " to $\frac{7}{16}$ " medium, and over that as heavy.

Holes for lacings should be no larger than is required to draw in the lace. The foregoing table, Fig. 223, gives the recommendation of a well-known belting firm for proportions.

(3) Place the ends of the belt together and begin the lacing. Put the lacing thru holes No. 3 and No. 8 from the grain side, Fig. 224. Draw the ends of the lace even.

(4) Place lace A thru hole No. 3, down thru No. 8, up thru No. 4, down thru No. 9, up thru No. 5, down thru No. 10, up thru No. 5, down thru No. 10, up thru No. 4, down thru No. 9, up thru No. 3. (5) Directly back of hole No. 3 punch a hole with an awl, and draw the remaining end of the lace thru this hole. Cut a slight slip close to the belt to prevent the end of the lace from withdrawing, Fig. 225. (6) Take lace B and work it in the opposite direction, passing successively thru Nos. 7, 2, 6, 1, 6, 1, 7, 2, 8. (7) Fasten back of No. 8.

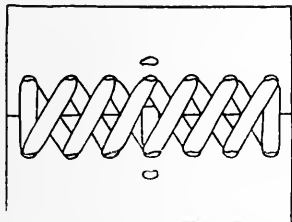

FIG. 225. STRAIGHT STITCH BELT LACE—FLESH SIDE.

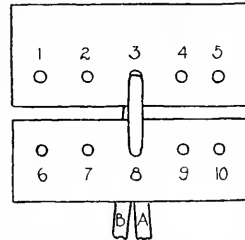
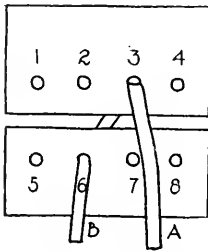

FIG. 224. STRAIGHT STITCH BELT LACING, GRAIN SIDE.

Where an even number of holes are made use of the following order is to be used: (1) Place the lace thru holes No. 3 and No. 6, Fig. 226, from the flesh side and

draw the ends even. (2) Place end A thru hole No. 7, up thru No. 4, down thru No. 8, up thru No. 4, down thru No. 8, up thru No. 3, down thru No. 7, up thru No. 2. (2) With the awl punch a hole directly back of hole No. 2 and fasten in the usual manner. (3) Pass the end B



of lace successively thru Nos. 2, 5, 1, 5, 1, 6, 2, 7. (4) Fasten back of No. 7.

There are other styles of lacing in common use, the directions for making which may be found in any belting manual such as put out by belting manufacturers.

FIG. 226. GRAIN SIDE, STRAIGHT STITCH BELT LACE, EVEN NUMBER OF HOLES.

Leather belts are of two kinds, oak tanned which is the most common, and elk tanned which has the appearance of elk hide. New belts when first placed upon pulleys will stretch a great deal. It is a good plan to stretch new belts before splicing them. Fig. 227 illustrates one method of stretching a belt. The ends are made fast and a stick or board the width of the belt sprung under the middle. A new belt should, on ordinary

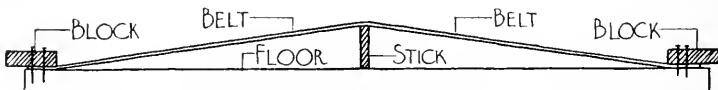

FIG. 227. PRELIMINARY STRETCHING OF A NEW BELT.

stretches, be made about 2" shorter than the distance about and between the pulleys measures. Belts should not be run any tighter than is absolutely necessary. Excessive strain on a belt means excessive strain on bearings with waste in friction. There is as much loss in tight as in loose belts.

134. **Selection of Belting.**—A belt should never be used which is as wide as its pulleys. A slight misalignment of shafting will cause the edges to rub against shifting fingers, causing damage to the belt and loss of power. Belts should never be held in place by cleats but the pulleys and shafting should be aligned properly.

Hanging belts vertically should be avoided if at all possible. If vertical belts must be used they should be thin and wide that they may grip the pulley. Preferably belts should be hung horizontally or at an angle, with pulleys neither too close nor too far apart and with slack side of belt above, if possible, to increase the arc of contact. Short belts do not give the tension of the belt time to recover before being placed under stress again. Long belts weight the bearings unnecessarily and have a tendency to weave about over the pulleys.

A belt should be able to transmit from 5 to 25 per cent overload. Single belts are best for small pulleys. Where the width of belt would be over $1\frac{1}{2}$ times the diameter of the smallest pulley, a narrower double belt should be used with relatively narrower pulleys. Ordinarily, double belts are used only on pulleys 18" in diameter or over.

The strongest belts are made from what is known as center stock leather. This means that such belts will be composed of short lengths with laps near together. Such belting is designated first quality. Belts made of side and shoulder stock are designated as second quality and are cheaper, being used for lighter work.

Good leather belting has an estimated strength of 4,000 to 4,500 pounds per square inch; lacings reduce this one-third. Pulleys of large diameter are better than those of small diameter, the belt speed being the same. A speed of 4,000 feet per minute is considered the best for transmission purposes.

The arc of contact is the amount of pulley circumference in contact with the belt. Where the pulleys are equal the arc of contact is 180° each.

The following formulae will assist in the proper selection of belting:

Speed in ft. per min.=Diam. of pulley in ft. \times 3.1416 \times R. P. M. of pulley.

H. P.=Speed in ft. per min. \times width of belt in ins. \times working tension, product \div 33,000. (For single belt use 55; double belt, 88; three-ply, 110.)

Width of belt to transmit given H. P.=Given H. P. \times 33,000, product \div belt speed in ft. per min. \times working tension. (Single belts, 55; double, 88; three-ply, 110.)

The above formulae apply only where the pulleys are equal or of nearly equal diameters without idlers. Where the arc of contact is other than 180° allowance for variation in working tension or effective pull must be made.

The term "working tension" or "effective pull" is used to represent the force necessary to turn the pulleys. It represents the difference in tension between the tight and loose sides of a belt, and varies among other things with the arc of contact of the smaller pulley. With an arc of contact of about 180° this value is approximately 55 pounds per inch of belt width, single belt, 88 for double, and 110 for three-ply.

Where arc of contact is not 180° .

Working tension or effective pull=Arc of contact \times 55 for single, 88 for double, and 110 for three-ply belts, product \div 180.

Arc of contact on smaller pulley may be found by stretching tape over the pulleys and then estimating the number of degrees contact by means of a protractor, Figs. 228 and 229.

Length of belt is ordinarily told by drawing a tape over the pulleys in the position the belt will have, allowance being made for splice.

Fig. 230 shows some of the more common "drives" and the relative positions of the pulleys to secure results.

Occasionally it is desired to know the length of belting in a roll. This can be found by adding the diameter of the hole in the center to the outside diameter of the roll, divide the result by 2, multiply by $3\frac{1}{7}$, and multiply this result by the number of coils in the roll. If the diameter is taken in inches the final result must be divided by 12.

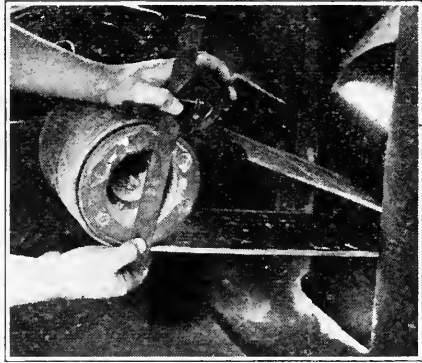

FIG. 228. DETERMINING ARC OF CONTACT.

135. Babbitting Bearings.—While babbitting is primarily the work of the millwright, the woodworker is called upon not infrequently to babbit bearings of wood-working machines which have worn out or been melted out thru too tight belting.

To rebabbit a journal, (1) take a cold chisel and cut out the old babbit. Be sure to clean out the anchor holes, which are holes bored in the sides of the boxing into which the babbit flows, forming an anchor.

(2) Line up the shaft in the lower boxing as accurately as can possibly be done in the position it is to occupy. (3) With a blow torch heat the inside of the boxing and journal quite hot—so hot it cannot be handled. (4) With putty or clay stop up the ends of the box so the babbit cannot run out. (5) Pour in the melted babbit up to the level of the top of the box. (6) While the journal is still

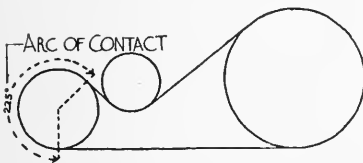

FIG. 229. ARC OF CONTACT.

warm, place the upper half of the box, having heated it. (7) Between these two halves liners should be placed. Liners are generally composed of three thicknesses of cardboard. When removed they allow the box to be

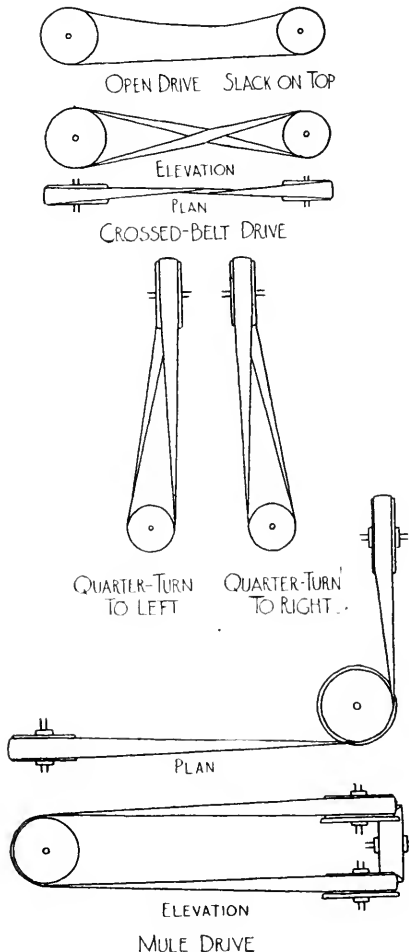

FIG. 230. COMMON "DRIVES."

adjusted. (8) Putty up the ends of the top half of the box, leaving a small vent hole at the top. (9) Pour the molten metal thru the oil hole in the top box.

A second method of babbitting, by pouring both halves of the box at once, is as follows: (1) Cut V-shaped notches in the liner for the babbitt to run thru, Fig. 231. (2) Place these liners, locating the shaft properly and stopping up the ends of the boxes, except the small vent hole. (3) Pour the metal thru the oil hole in the top box. The metal will flow thru the V-shaped notches in the liners into the lower box. (4) Break the box apart by a quick, sharp blow on a cold chisel, held to cut between the boxes.

If the notches are made the sizes of those of the illustration, they will admit the babbitt and still permit the boxes to be broken apart easily. To vary the size much

will make for trouble, either the babbitt will not flow thru or the boxes cannot be easily broken apart.

Babbitt is ready to pour when it is heated so that it will readily char a pine stick such as the reverse end of a match.

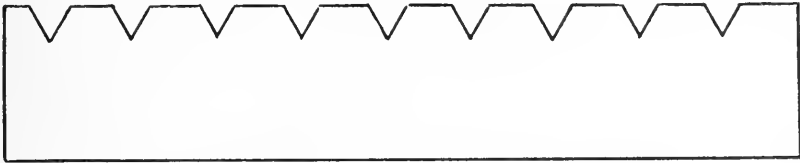

FIG. 231. LINER FOR BABBITTING BEARINGS.

136. Dust Exhaust System.—Modern factories have complete arrangements whereby shavings, dust and chips

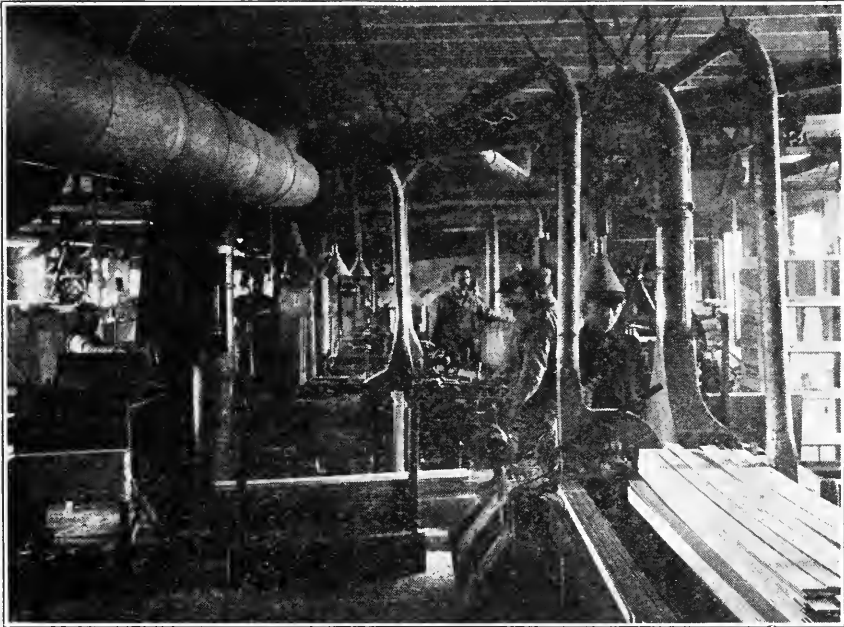

FIG. 232 . EXHAUST SYSTEM—INTERIOR PIPING.

from the various machines are taken away by exhaust thru a system of piping. The exhaust system is well illustrated in Figs. 232, 233, and 234, which show the

pipng about the machines, and the exit of the refuse at the boiler room where it is used for fuel.

The outlet pipe for such a system should remain full size until the shavings reach the boiler room or shaving pit. The intake pipes may diminish in size as limited by capacity. If a shop system should make use of a 24" fan for exhausting purposes, a 10" or 11" main would be

used. A planer would have a 5" pipe leading to this, the saw a 3" pipe, etc. The sum of the areas of the intake pipes must not be greater than the area of the outlet pipe.

A 24" fan should run 2,500 R. P. M. and will take a 4 H. P. motor to do medium work.

137. Shaft Drive vs. Individual Motor Drive.
—Next to the exhaust system nothing aids so greatly in keeping a well ordered shop as the use of electrically distributed power. The

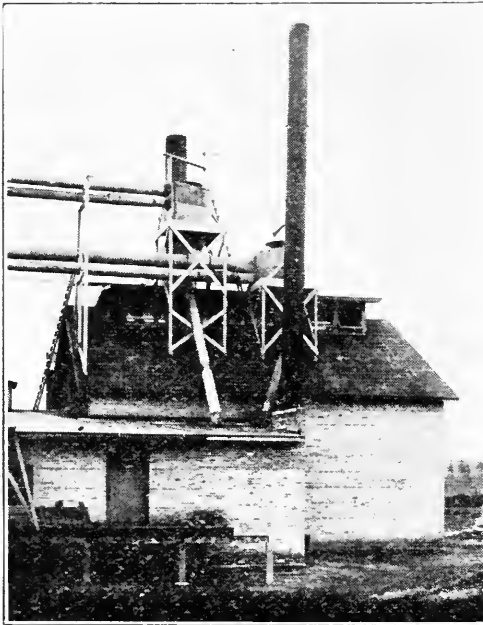

FIG. 233.

EXHAUST SYSTEM—EXTERIOR PIPING.

relative merit of shaft-driven vs. motor-driven machines has been a source of considerable discussion. The consensus of opinion seems to be, that where heavy machines are operated either continuously or for part time, where the load is constant, direct motor drive is desirable. With light running machines, all of them never running to their full capacity at any one time, and where the loads

are variable, such as with a classroom in wood-turning, the group drive consisting of a number of machines connected to a shaft, with these shafts each electrically driven, is considered better.

One of the objections to the direct motor drive is the strain put upon the motor by variable loads upon the machine. This is overcome greatly by either a flexible coupling, Fig. 235, or an intervening belt drive.

138. Calculating Speeds and Diameters of Pulleys, Saws, Grindstones, Etc.—The term, "speed," as applied to pulleys, has reference to the number of revolutions the pulley will make in a minute, usually indicated by the abbreviation R. P. M.

Cutting speed or surface speed of a saw, a lathe, a grindstone, etc., has reference to the number of lineal feet of stock or of toothed edge, etc., which will pass a given stationary point in one minute of time.

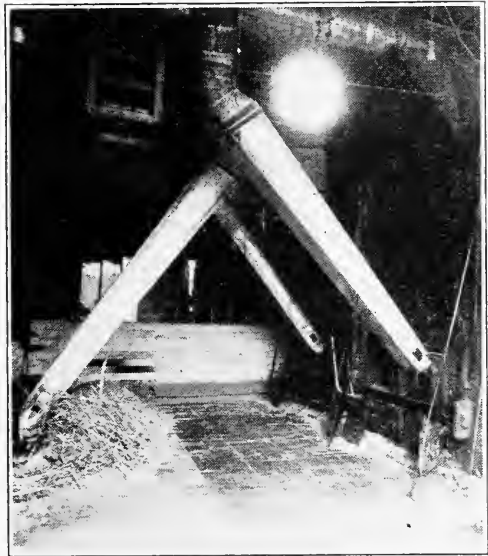

FIG. 234. EXHAUST SYSTEM—PIPING IN BOILER ROOM.

Rule for cutting speed: Multiply the number of feet in the circumference of the work being turned by the number of revolutions per minute to get the cutting speed in feet per minute.

Rule for pulley speeds: The diameter of a driving pulley times its R. P. M. equals the diameter of the

driven pulley times its R. P. M.

Where a series of driving and driven pulleys must be traced in order to determine a fact at one extreme or the other, as finding the speed of a machine knowing the speed of the driving motor and the diameters of the various pulleys intervening, the operation is simplified by knowing that the continued product of the speed or

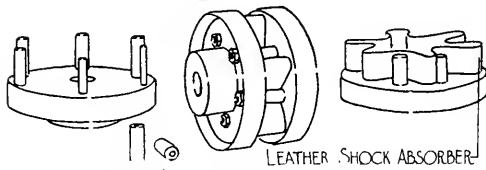

FIG. 235. FLEXIBLE COUPLING.

R. P. M. of the first driver by the diameters of the various drivers is equal to the continued product of the R. P. M. of the last

driven pulley and the various driven pulley diameters.

Let S = the cutting or surface speed; c = circumference of the work; then

$$S = c \times \text{R. P. M.} \quad (c = \text{diameter} \times 3 \frac{1}{7}).$$

Let D = diameter of driving pulley and d = diameter of driven pulley; R. P. M. the speed of the driving pulley and $r. p. m.$ the speed of the driven pulley, then

$$D \times \text{R. P. M.} = d \times r. p. m.$$

whence

$$D = \frac{d \times r. p. m., \text{ etc.}}{\text{R. P. M.}}$$

Or, in a series

$$D \times D' \times D'' \times \text{R. P. M.} = d \times d' \times d'' \times r'' p'' m''$$

whence

$$r'' p'' m'' = \frac{D \times D' \times D'' \times \text{R. P. M.}}{d \times d' \times d''}, \text{ etc.}$$

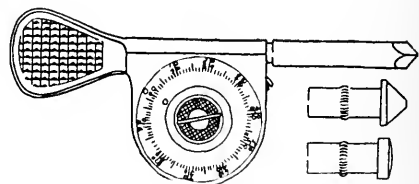

FIG. 236. SPEED INDICATOR.

Where transmission is thru gears instead of pulleys, as in determining the feed of a planer, the following rules are applicable:

Rule for speed: The speed or R. P. M. of any two meshing gears is inversely proportional to the number of teeth.

Where a train of gears is to be figured, the continued product of the R. P. M. of the first driver and the number of teeth in the various driving gears equals the continued product of the R. P. M. of the last driven gear and the number of teeth in the various driven gears.

An intermediate gear is a gear used merely to transmit power from one gear to another. As it does not affect the speed ratio of driver and driven gear it may be neglected in figuring the train of gears. One or more of these intermediate gears will be found in every train, a train consisting of three or more gears in mesh.

Let S = speed or R. P. M. of driving gear; s = speed of driven gear; T = number of teeth of driver and t = number of teeth of driven gear, then

$$S:s::t:T,$$

whence

$$s = \frac{S \times T}{t}, \text{ etc.}$$

Also,

$$S \times T \times T' \times T'' = s \times t \times t' \times t'',$$

whence

$$s = \frac{S \times T \times T' \times T''}{t \times t' \times t''}, \text{ etc.}$$

Fig. 236 illustrates a tool known as a speed indicator. The pointed end is held firmly against the end of a revolving shaft and the number of revolutions in a given time may be read on the graduated dial.

CHAPTER IV.

JOINERY.

139. **Joinery.**—This term in its broader meaning refers to the art of framing the finishing work of a house, such as doors and windows; and to the construction of permanent fittings, such as mantels, cupboards, linen presses, etc. Joinery as used herein refers merely to the putting together of two or more parts, called the members.

Joinery, in its first meaning, is well illustrated by the many articles of completed furniture to be found illustrated thruout the book, in its second meaning by Figs. 271-277.

140. **General Directions for Joinery.**—Take into consideration the direction of the grain in planning the relative positions of the members. Make due allowance where shrinkage is likely to be considerable.

As far as possible, plan to have the members join face to face. Face sides are more likely to be true than are the other two surfaces and therefore the joints are more likely to fit properly.

Make all measurements from a common starting point, as far as practicable. Remember to keep the head of the gage and the beam of the try-square against one or the other of the faces, unless there should be special reason for doing otherwise.

In practice it is sometimes advisable to locate the sides of a joint by superposition rather than by measurement.

Laying out by superposition consists in placing one

member upon another and marking upon the second member the width, thickness or length of the first. Usually, it is found possible to locate and square with knife and try-square a line to represent one of the sides of the joint. The first member is then held so that one of its arrises rests upon this line, and a point is made with knife at the other arris. The superimposed piece is then removed and a line made with knife and try-square—not thru the mark of the knife point but inside, just touching it. Fig. 237 illustrates locating with center lines.

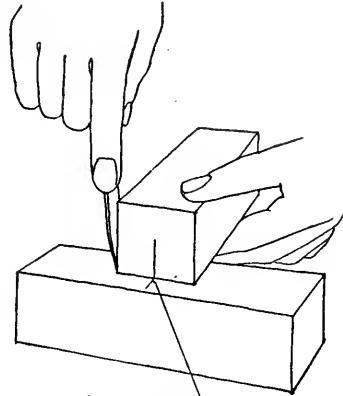

CENTER LINES
FIG. 237. LOCATING
WITH CENTER LINES.

Where several members or parts are to be laid out, cut and fitted, it is of the utmost importance that the work be done systematically. System and power to visualize—that is, to see things in their proper relation to one another in the finished piece—make it possible for men to lay out and cut the members of the most intricate frames of buildings before a single part has been put together. Lay out duplicate parts and duplicate joints as taught in elementary woodwork, Fig. 238. Where several joints of

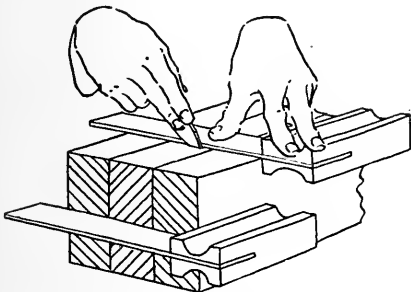

FIG. 238. LAYING OUT
DUPLICATE PARTS.

a similar size and kind are to be fitted, mark the different parts to each joint with the same number or letter as soon as fitted, that no other member may be fitted to

either of these, Fig. 239. On small pieces, such as the stool, it is possible to aid in visualizing by setting up the posts in the positions they are to occupy relative to one another, marking roughly, as with a penciled circle, the approximate location of the mortises, auger holes, etc., Fig. 240. The members may then be laid on the bench and accurately marked without danger of misplacing the openings.

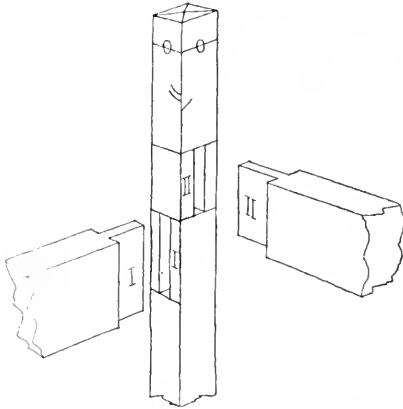

FIG. 239. MARKED DUPLICATE PARTS AND JOINTS.

While the knife is used almost exclusively in laying out joints, there are a few instances in which a pencil, if well sharpened and used with slight pressure, is preferable. To illustrate: suppose it is desired to locate the ends of the mortises in the posts, Fig. 239. To knife entirely across the surfaces of the four pieces and around the sides of each, as would be necessary to locate the ends of the mortises, would injure the surfaces. Instead, pencil these lines and gage between the pencil lines. Those parts of the pencil lines enclosed by the gage lines—the ends of the mortises—

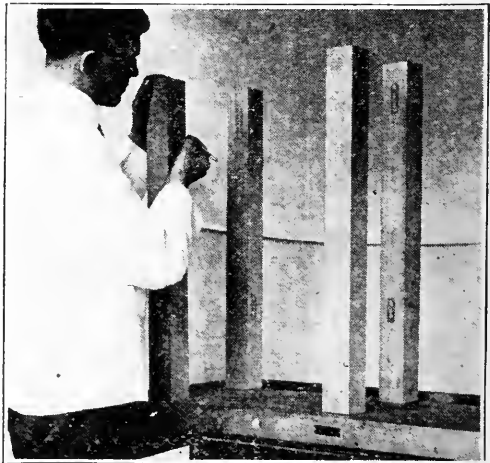

FIG. 240. MARKING APPROXIMATE LOCATION OF MORTISES, AUGER HOLES, ETC.

may then be knifed, if desired, to assist in placing the chisel for the final cut.

In sawing joints in hard wood, the saw should be made to cut accurately to the line. When working soft wood, beginners are often permitted to leave a small margin—about one thirty-second of an inch—between the knife line and the saw kerf. This margin is afterward pared away with the chisel.

In assembling framework and the like, where it is necessary to drive the parts together, always place a block of wood upon the member to be pounded to take the indentations that will be made. A mallet is preferable to a hammer for such pounding.

141. Dado.—A dado, Fig. 241, is made by cutting a rectangular groove entirely across one member into which the end of another member fits. Dados are cut across the

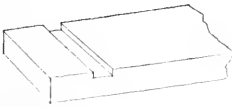

FIG. 241. GROOVE FOR DADO.

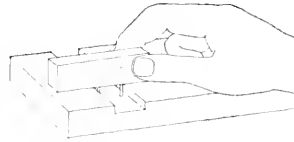

FIG. 242. TESTING GROOVE FOR DADO.

grain of the wood; when similar openings are cut parallel to the grain, they are called simply grooves. Dados are used in the making of shelving, window and door frames, etc.

142. Directions for Dado.—(1) Locate by means of the rule one side of the dado, and mark its position with the point of the knife. (2) At this point, square a sharp line across the piece with knife and try-square. (3) By superposition, locate and mark the second side. (4) Square these lines across the edges of the piece a distance equal to the approximate depth of the dado. (5) Set the

gauge for the required depth and gauge between the knife lines on the two edges. (6) Saw just far enough inside the knife lines that the sides of the dado may be finished to the lines with the chisel. Saw down just to the gauge lines, watching both edges that the kerfs be not made too deep. (7) Chisel out the waste until the bottom of the dado is smooth and true. Test the bottom as shown in Fig. 242. Two brads are driven into a block having a straight edge, until they project a distance equal to the proposed depth of the dado. (8) Pare the sides of the dado to the knife lines. These sides might be finished in another way, by setting a wide chisel in the knife line and tapping it gently with a mallet. If care is taken the successive settings of the chisel need not show.

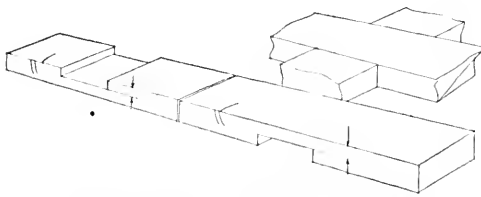

FIG. 243. CROSS-LAP JOINT.

Where the dado is to be cut on a piece narrow enough that the saw may be made to follow the line accurately, it is considered better practice to saw accurately to the line.

143. Cross-Lap Joint.—Usually, stock for the two members of the cross-lap joint can be best planed to width and thickness in one piece. Place two sets of face marks on the piece, so that there shall be one set of marks on each member after they are separated. Two methods of making this joint are given. The first is safer for beginners; the second, because the members cannot be tried until the joints are completed, is an excellent test of one's ability. Fig. 243.

144. Directions for Cross-Lap Joint.—First Method: (1) Square the two ends, measure from each of these the

desired length of each member, square knife lines around, saw apart, finishing the ends square to the lines. (2) Measure from one end of each member the required distance to the nearer edge of the joint. Since the corresponding faces of the two members must be on the same side of the piece when the parts are put together, it will be necessary to lay off the groove of one member on the face, and of the other member on the side opposite the face. If the joints are to be

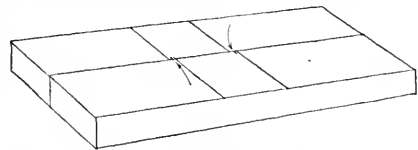

FIG. 244. SHOWING METHOD OF LOCATING POSITION FOR CORRESPONDING LINES.

in the middle of each member but one measurement need be made. (3) Square sharp knife lines across at these points. (4) By superposition, locate and knife the second edge of each joint. (5) If the joints are to be in the middle of each member, before proceeding farther, test to see that the lines have been laid out properly. If the members are placed side by side and the ends evened

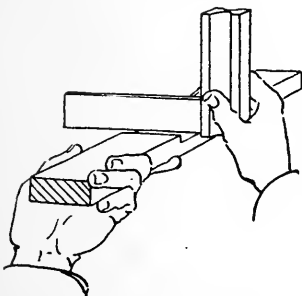

FIG. 245. TESTING GROOVES OF LAP-JOINT.

as in laying out in (2), the lines will of necessity correspond. Turn one of the members end for end and even the two ends; the lines ought still to correspond. If they do not, points marked midway between the corresponding lines will give the correct position for the new lines, Fig. 244.

(6) Extend the knife lines across the two adjoining surfaces of each member. (7) Set the gage for the required depth and gage between the knife lines on the surfaces. Tho the groove on one member is laid out on the side opposite the face, do not make the mistake of holding the head of the gage against other than the face. (8) Saw accurately

to the knife lines and to a depth indicated by the gage lines. (9) Chisel out the waste stock. (10) Test as shown in Fig. 245. A well-made cross-lap joint is one in which the members can be put together with the pressure of the hands and which will not fall apart of its own weight. Fig. 246 shows the results of "forcing a fit."

145. Directions for Cross-Lap Joint.—Second Method.

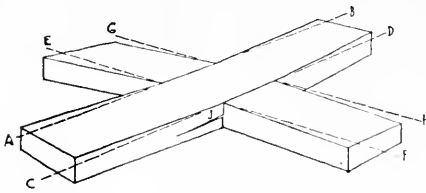

FIG. 246. SHOWING RESULTS OF FORCING FIT IN LAP-JOINT.

The two members are to be planed to width and thickness in one piece, but are not to be separated until the grooves have been laid out and cut. The grooves must be laid out

by measurement only, since superposition is impossible. The positions of the grooves relative to the face are, as in the first method, one on the face and one on the side opposite. The gaging for both is done from the face.

146. Glue Joint.—Frequently it becomes necessary to glue together a number of boards to make one wide enough to meet the requirements of the work in hand. A table top is a good illustration. A properly glued butt joint ought to be stronger than the natural wood.

When the wood is of sufficient thickness, the joint may be reinforced by means of dowels. The jointer should be used for planing the edges. It is extremely difficult to prepare edges for glue joints with the shorter planes. The jack-plane should be used to rough off the edges and prepare them for the jointer.

147. Directions for Glue Joint.—(1) If the boards are in the rough, plane one surface of each true and out of wind. (2) Pencil the face marks upon these surfaces and indicate in some way the direction of the surface grain as well. Later, it will be necessary to plane both pieces at

once in surfacing over the joints, and unless the parts are fitted with proper regard to the grain, it will be impossible to plane one without roughing up the other. Then, too, the faces should be so selected that the warpage of one shall counteract the warpage of the other. Fig. 247 shows the manner of placing the pieces. Observe the rings of growth. Boards which have the annual rings extending directly across, quarter-sawed boards, will be found best for making up table tops, etc., because less subject to warpage. If plain or bastard sawed stock is to be used it may be found advisable to rip wide boards into widths of four to six inches, reversing each piece as in Fig. 247. (3) Joint one edge of each piece straight and square. The final plane strokes must be taken the full length of the board and the plane-

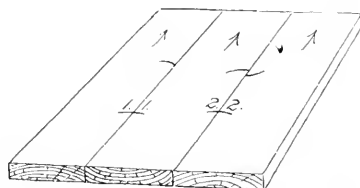

FIG. 247. POSITION OF PARTS
—GLUE JOINT.

iron must be set very shallow. Since the shrinkage is more at the ends than in the middle, sometimes the middles of long boards are planed just a shaving or two lower than the ends.



FIG. 248. PLANING EDGES FOR GLUE
JOINT.

A more common practice among practical woodworkers is to place the two pieces in the vise, face surfaces together, and plane the two edges at once, using a jointer with the iron ground squarely across. Fig. 248. No try-square

test is necessary but the edges must be straight. When the boards have been jointed straight and as nearly square across as the worker can estimate by the "feel"

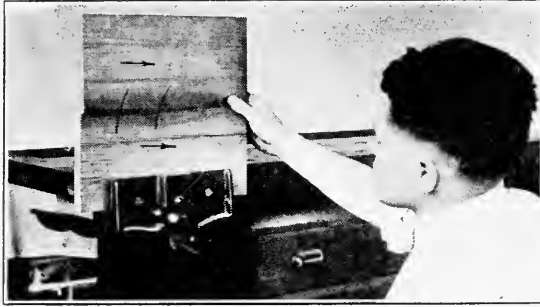

FIG. 249. TESTING GLUE JOINT.

of the position of the plane while working, the vise is released and one of the boards is revolved edge over edge and set in position upon the other board. If one member is revolved in this way

it may be observed why no try-square test is necessary—any inclination or bevel on one member being equalized by a corresponding opposite bevel on the other. The members should be marked as in Fig. 247 so that they may be properly and quickly placed when glued, ready for clamping. (4) Place one of the boards in the vise, jointed edge up, and place the other board in position on it. Four tests are commonly used: First, placing the eye on a level with the joint and looking toward the light, Fig. 249; second, tapping the under board lightly to see if the top board "rocks"; third, sliding the top board lengthwise slowly to "feel" for suc-



FIG. 250. TESTING FACES OF GLUE JOINT.

tion; fourth, holding a straight-edge as shown in Fig. 250, to see that the faces lie in the same plane. (5) Glue the edges, Fig. 251. Work rapidly but carefully. (6) Place the parts in the clamps and set away to dry; ten hours is usually long enough. Keep the faces as even as possible in applying the clamps. (7) When the glue has hardened the clamps may be removed, the surplus glue scraped off and the parts treated as one piece in squaring it up.

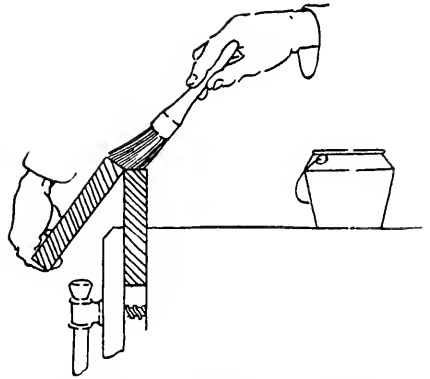

FIG. 251. APPLYING GLUE TO EDGES OF BOARDS.

148. Doweling.—Dowels are small wooden pins used in joining parts together. Dowels can be bought ready

made in a variety of sizes. If desired short dowels may be made as follows: (1) Select straight-grained, strong wood—beech, birch or oak; waste wood can usually be found that will do. (2) Split, not saw, these pieces roughly to square prisms. The blocks from which they are to be split should not be

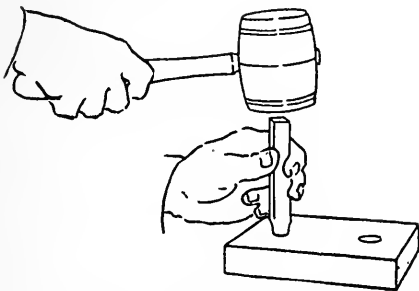

FIG. 252. DRIVING DOWEL RODS THROUGH PLATE.

over eight or ten inches long to work well. (3) Plane off the irregularities, roughly rounding the pieces to size. (4) Point the ends slightly and drive the pieces thru a dowel plate, Fig. 252. The pegs should be driven thru the larger hole first. The holes of the dowel plate are larger in diameter on one side of the plate than on the other to give clearance to the peg as it is driven thru.

The cutting edge of the hole is at the smaller diameter ; place that side of the plate up. Never use a hammer as it would split the top of the peg and would ruin the cutting edge of the dowel plate should it strike it. Use a mallet, and when the peg is nearly thru finish by striking a second peg placed upon the head of the first.

149. Directions for Doweling.—(1) Place the boards to be doweled side by side in the vise, the face sides out, and even the jointed edges. (2) Square lines across the two edges with knife and try-square at points where it is desired to locate dowels. (3) Set the gage for about half the thickness of the finished board and gage from the face side across knife lines. (4) At the resulting crosses bore holes of the same diameter as that of the dowel.

These holes should be bored to a uniform depth. Count the turns of the brace. One inch is a good depth for ordinary work. (5) Countersink the holes slightly, just enough to remove the sharp arrises. This removes any burr and allows a little space into which the surplus glue may run. (6) Cut the sharp arrises off the dowel, just

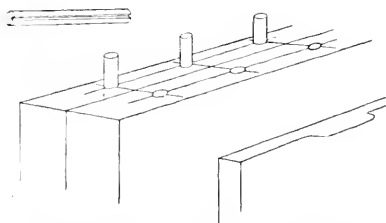

FIG. 253. DOWELED JOINT.

enough to allow it to be started into the hole. (7) With a stick slightly smaller than the hole, place glue upon the sides of the hole and drive the dowel in. A narrow saw kerf previously cut along the side of the dowel will allow the surplus glue to escape and thus prevent any danger of splitting the board. (8) Clean off the surplus glue, unless the members can be placed together before it has had time to set. (9) Saw off the dowels to a length slightly less than the depth of the holes in the second

piece. (10) Trim off the sharp arrises, Fig. 253. (11) Glue the holes and the edge of the second board. (12) Put the two members in the clamps and set away until the glue has had time to harden.

150. Keyed Tenon-and-Mortise.—Fig. 254 shows the tenon, the mortise in the second member into which the tenon fits, the mortise in the tenon and its key or wedge.

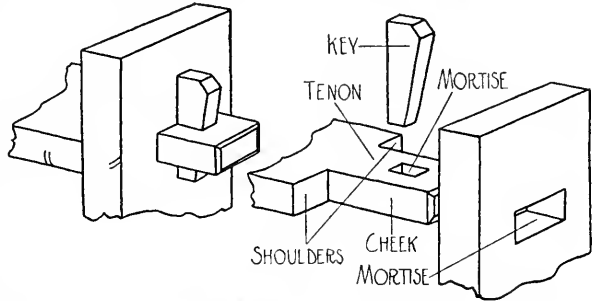

FIG. 254. KEYED MORTISE-AND-TENON JOINT.

151. Directions for Key.—Keys are made in quite a variety of shapes. Some of

the simple forms are shown in Fig. 255. Where two or more keys of the same size are to be made, it is customary to plane all in one piece. (1) Plane a face side, a face edge, and shape the remaining edge as desired. If there is more than one key, (2) Gage and plane each to thickness. The lines A-B and C-D, Fig. 255, indicate the points at which measurements are to be made to determine the length of mortise in the tenon which is

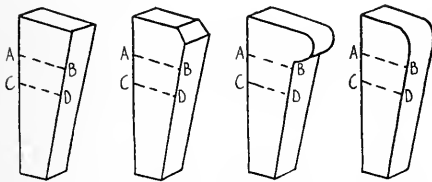

FIG. 255. SIMPLE FORMS OF KEYS.

to receive the key. These lines should be laid off at a distance apart, equal to the thickness of the tenon.

152. Directions for Tenon.—(1) Measure from the end of the piece the length of the tenon, and mark with a knife point. Where tenons are to be cut on both ends of a piece, measurement is frequently made from the middle of the piece each way, to locate the shoulders. Should there be any variation in

the length of the piece from what it should be, this difference will then be equally divided at the ends. This is done when it is more important to have the distance between the shoulders of a definite length, than that the tenons be of correct length. (2) Square knife lines entirely around the piece at the knife point mark. (3) Set the gage equal to the distance required from the face

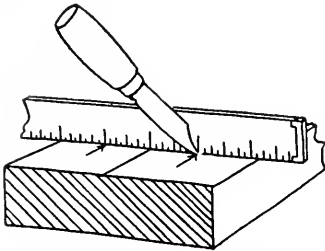

FIG. 256. MARKING WITH POINT OF KNIFE.

edge to the nearest edge of the tenon, and mark on both sides, as far as the shoulder marks, and on the end. (4) Repeat, setting the gage from the face edge to the farther edge of the tenon. If the two members are of the same width and the tenon and mortise are to be equally distant from the face edge, both tenon and mortise should be gaged with the same settings. Frequently the gage settings are obtained from the rule indirectly. The rule is laid across the piece and the width or thickness of mortise or tenon marked with the point of a knife blade, Fig. 256. The spur of the gage is then set in one of these points, the block being pushed firmly against the face; the thumb screw is then fastened, Fig. 257. The second setting is obtained in a similar manner from the same edge or side. All

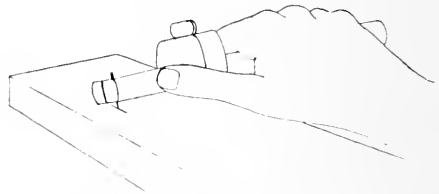

FIG. 257. GAGE SET TO MARK.

the pieces are marked for the first width before resetting. (5) After having laid out the mortise in the tenon (see 1, Sec. 154), rip to the gage lines and cross-cut to the shoulder lines, paring if necessary. (6) Slightly chamfer the ends of the tenon.

153. Directions for Mortise.—(1) From one end of the piece measure and mark with the knife point the respective distances to the two edges of the mortise. (2) Square lines across the face edge and the two broad surfaces at these points. (3) Set the gage equal to the required distance from the face edge to the nearer edge of the mortise and mark between the lines. (4) Set the gage equal to the required distance from the face edge to the farther edge of the mortise and mark between the lines. Make both gage lines on face side and side opposite as well. (5) Cut the mortises. First, bore a series of holes thru the mortise, using a bit somewhat smaller than the width of the mortise. Bore these holes so that they connect one with another. (6) Place the piece on a chiseling board and, taking thin cuts about half way thru, work from the middle of the mortise out to within one thirty-second of an inch of the knife and gage lines. (7) Reverse and chisel from the other side, finishing it; then chisel the first side out to the lines. Test the sides of the mortise with a straight-edge—the blade of the chisel makes a good one—to see that they are cut straight. Fig. 258.

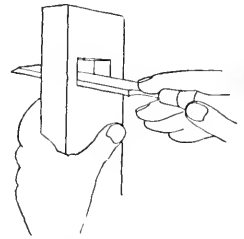

FIG. 258.
TESTING SIDES.

154. Directions for Mortise in the Tenon.—(1) Lay out the sides of the mortise for the key before the sides and shoulders of the tenons are cut. From the shoulder line of the tenon, measure toward the end a distance slightly less (about $\frac{1}{32}$ ") than the thickness of the member thru which the tenon is to pass. This is to insure the key's wedging against the second member. (2) Square this line across the face edge and on to the side opposite the face side. (3) On the top surface measure from the

line just squared around the piece a distance equal to the width the key is to have at this point when in place, Fig. 255, A-B. (4) Square a pencil line across the surface at this point. (5) In a similar manner, measure and

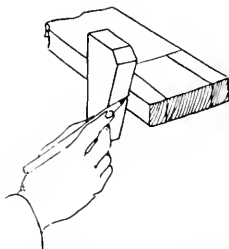

FIG. 259. LAYING OFF MORTISE FOR KEY OR WEDGE.

locate a line on the opposite side, C-D, Fig. 255. (6) Set the gage and mark the side of the mortise nearer the face edge on face side and side opposite. (7) Reset, and from the face edge gage the farther side of the mortise, marking both sides. (8) This mortise may be bored and chiseled like the one preceding. As one side of the mortise is to be cut sloping, a little more care

will be needed.

A second method of laying out the mortise in the tenon consists in locating the ends of the mortise by placing the key as in Fig. 259 and scribing along the sloping side. These lines are then squared across the two surfaces of the tenon. The remainder of the procedure is similar to that just described.

155. Blind Mortise-and-Tenon.—Probably no joint has a greater variety of applications than the blind mortise-and-tenon, Fig. 260. It is of equal importance to carpentry, joinery and cabinet-making. The tenon shown has four shoulders; it is often made with but three or two.

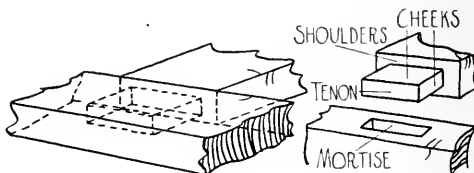

FIG. 260.

BLIND MORTISE-AND-TENON JOINT.

156. Directions for Tenon.—(1) Measure from the end of the piece the length of tenon (see also directions for tenon, Sec. 152), and mark with the point of a knife.

(2) Square knife lines entirely around the four sides at this point to locate the shoulders. (3) Lay the rule across the face edge near the end of the piece and mark points with the end of the knife to indicate the thickness of the tenon, Fig. 256. (4) With the head of the gage against the face side, set the spur of the gage in one of these marks, then fasten the thumb screw, Fig. 257. Gage on the end and the two edges as far back as the knife lines. When there are several tenons remember to mark all of them before resetting. (5) Set the gage in the other mark, the head of the gage being placed against the face side; then gage as before. (6) In a similar manner, place the rule across the face side, mark points with the knife for the width of tenon, set the gage to these points, and gage on the face and side opposite as far as the shoulder lines and across the end. The head of the gage must be held against the face edge for both settings. (7) Rip to all of the gage lines first, then cross-cut to the shoulder lines, using back-saw. (8) The end of the tenon may be slightly chamfered that it may be started into the mortise without tearing off the arrises of the opening.

157. Directions for Laying out Mortise.—(1) From one end of the piece measure the required distance to the nearer and the farther ends of the mortise. Mark points with the knife. (2) Square lines across at these points. (3) Lay the rule across the face into which the mortise is to be cut, and mark points with the knife for the sides of the mortise. (4) Set the gage as was done for the tenon, the spur being placed in the knife point mark and the head of the gage being pushed up against the face. Gage between the cross lines. (5) Reset from the same face for the other side of the mortise, and then gage.

If a mortise or tenon is to be placed in the middle of a

piece, find the middle of the piece and with the knife place points to each side of the center mark at a distance equal to one-half the thickness or width of the tenon or mortise. When several mortises or tenons of the same size are to be laid out and are to be equally distant from a face, the gage needs to be set but twice for all—once to mark the nearer edges and once for the farther edges of the tenon or mortise. Should there be several like members with like joints, the gage settings obtained from the first piece will suffice for all.

The importance of working from face sides or face edges only, cannot be overestimated. To work from either of the other two sides of a piece would make the joints subject to any variation in the widths or thicknesses of the pieces. To gage from the faces only, insures mortises and tenons of exact size no matter how much the pieces may vary in widths or thicknesses.



FIG. 261. LAST STEP IN MORTISING.

158. Directions for Cutting Mortise.—Two methods of cutting mortises are in common use, (a) boring and chiseling, and (b) chiseling alone. First method: (1) Fasten the piece in the vise in a horizontal position. (2) Bore a series of connecting holes to the required depth with a bit slightly smaller than the width of the mortise. (3) The sides of the mortise are next pared to the gage and knife lines, beginning at the auger

holes and working with thin slices toward the lines. This method requires care and patience in order to get the

sides of the mortise cut square to the surface. It is especially well adapted to large mortises from which much wood is to be removed.

159. Directions for Cutting Mortise.—Second Method: (1) Clamp the piece which is to be mortised firmly to the bench top, using a hand clamp. Fig. 261 illustrates the proper position for the worker at the bench. Tighten the vise screw until it holds the piece solidly. (2) Select a chisel of a width equal to that desired for the mortise. Stand well back of the mortise at one end or the other so as to be able to sight the chisel plumb with reference to the sides of the mortise. (3) Begin the cutting in the center of the mortise. Make the first cut with the bevel of the chisel toward you; reverse the bevel and cut out the wedge-shaped piece, *w*, Fig. 262.

(4) Continue cutting in this manner until the proper depth has been attained, making the opening no larger at the surface than is necessary. (5) Set the chisel in a vertical position, bevel towards you, begin at the center and, taking thin slices, cut toward the farther end. Drive the chisel the full depth of the mortise each time, then pull the handle towards you to break the chip from the sides of the mortise. Cut to within $\frac{1}{8}$ " of the end of the mortise. (6) Reverse the piece, or your position, and cut in a similar manner to within $\frac{1}{8}$ " of the second end. (7) With the bevel side of the chisel next to the end of the mortise pry out the chips once or twice as the cutting proceeds. (8) Chisel the ends to the knife lines, carefully sighting the chisel for the two directions. Fig. 263 suggests the order.

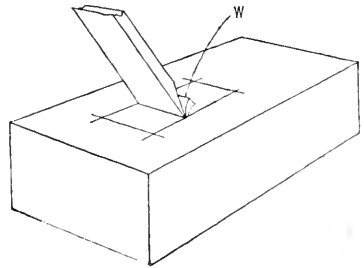

FIG. 262. CUTTING OUT WEDGE-SHAPED PIECE.

160. **Miter Joint.**—The miter joint is subject to various modifications. In the plain miter, Fig. 264, the ends

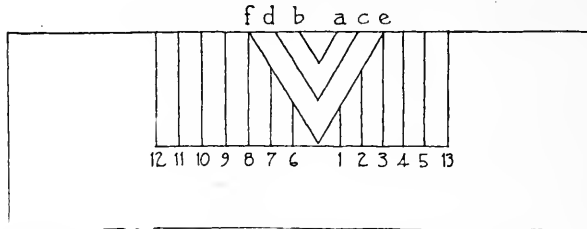

FIG. 263. ORDER FOR CHISELING OUT MORTISE.

or edges abut. They are usually fastened with glue or nails or both. The most common form of the plain miter is that in which the slope is at an angle of 45° to the edge or side.

161. **Directions for Miter Joint.**—(1) Lay off the slopes. (2) Cut and fit the parts. To fit and fasten four miter joints, such as are found in a picture frame, is no easy task. Special miter boxes are made for this purpose which make such work comparatively easy. (3) Fig. 265 shows the manner of applying the hand clamps to a simple miter joint. When a joint is to be nailed, drive the nail thru one piece until its point projects slightly.

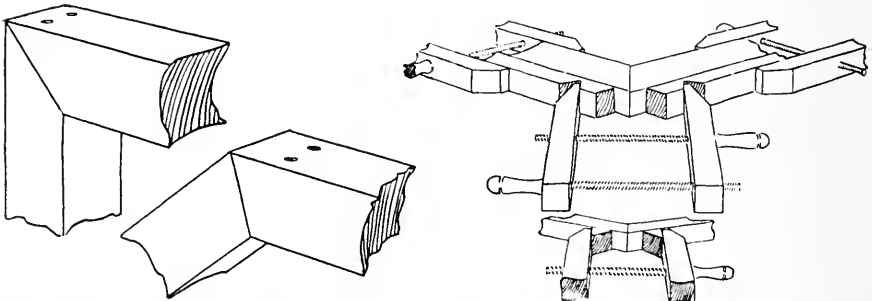

FIG. 264. PLAIN MITER JOINTS. FIG. 265. CLAMPING MITER JOINT.

Place the second piece in the vise to hold it firmly. Hold the first piece so that its end projects somewhat over

and beyond that of the second; the nailing will tend to bring it to its proper position, Fig. 266. If a nail is driven thru from the other direction, care must be taken to so place it that it will not strike the first, or a split joint will result.

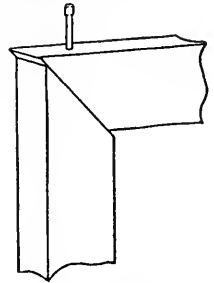

FIG. 266.
METHOD OF
NAILING MITER
JOINT.

162. Dovetail Joint.—Dovetailed joints are so named from the shape of the pieces which make the joint. Fig. 267 shows a thru multiple dovetail commonly used in fastening the corners of tool boxes. In hand-made dovetails, the tenons are very narrow and the mortises wide, while in machine-made dovetails, tenons and mortises are of equal width. Mechanics lay out the tenons without measurement, depending upon the eye unaided to give the proper size and shape. Sometimes dovetails are laid out to exact shape and size, the tenons being marked on both

sides and ends. The mortises are marked with try-square and bevel after one side of each has been marked by superimposing the tenons. In some kinds of dovetailing, such as the half-blind dovetail, the mortises are made first and the tenons marked out from them by superposition.

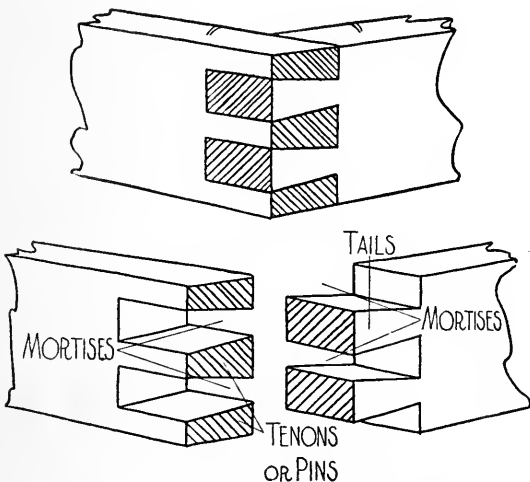

FIG. 267. DOVETAIL JOINT.

163. Directions for Dovetail Joint.—(1) Square lines around each end to locate the inner ends of the mortises and tenons. These lines will be at a distance from the ends equal to the respective thicknesses of the pieces. (2) Determine the number of tenons wanted and square center lines across the end of the member which is to have the tenons. Place these center lines so that the intervening spaces shall be equal. (3) Measure along an arris and mark on either side of these center lines one-half of the desired width of the tenon. In fine hand-made dovetails, the usual width for the narrow edge of tenon is scarcely more than one-sixteenth

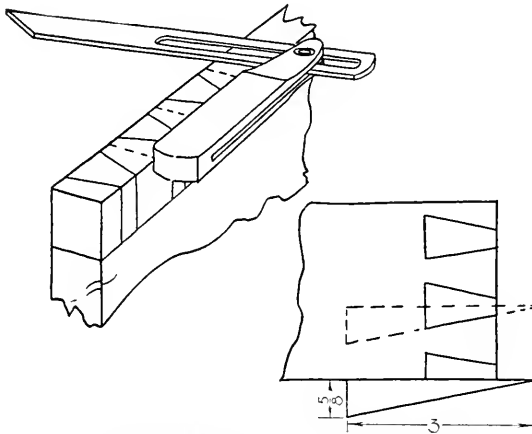

FIG. 268. MARKING DOVETAIL JOINT.

of an inch—the width of a narrow saw kerf. (4) Set the bevel for the amount of flare desired. Fig. 268 shows measurements which may be used in setting the bevel. A flare stick may be made of thin wood and used instead of a bevel if desired, Fig.

268. (5) Mark the flares on either side of the center lines. Place the bevel so that the wide side of the tenon shall be formed on the face side of the piece. (6) Carry these lines back on each side of the piece as far as the lines previously drawn across these sides. (7) With a fine tenon saw rip accurately to the lines. Cut the kerfs out of the mortises, not out of the tenons. (8) Chisel out the mortises formed between the tenons, and trim up any irregularities in the tenons. (9) Set the tenons

on end on the face side of the second member, with the face side just touching the cross line placed on the second member, Fig. 269, and mark along the sides of the tenons. (10) Square lines across the end to correspond with the lines just drawn. (11) Saw accurately to the lines, cutting kerfs out of the mortises, not the tails. Chisel out the mortises for the tenons, Fig. 270. (12) Fit the parts together.

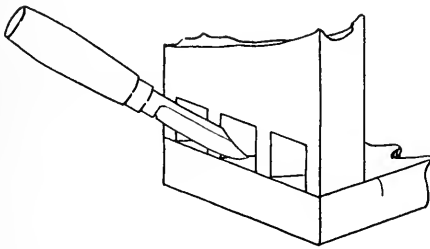

FIG. 269.

MARKING SECOND MEMBER.

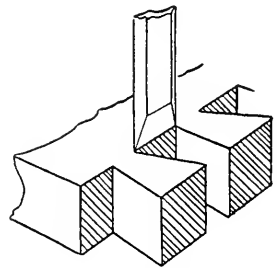
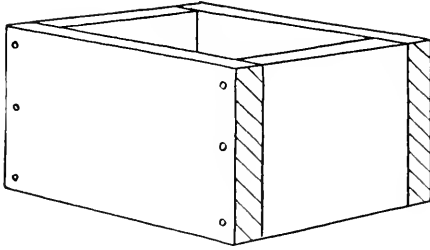

FIG. 270.

CHISELING MORTISES.

164. Additional Joints.—In addition to the typical joints just described, the following forms of fastenings will be found in common use: Figs. 271 to 277. With the information and experience obtained in the making of the type forms, one should have little difficulty in laying out and constructing these additional forms.



BUTT JOINT

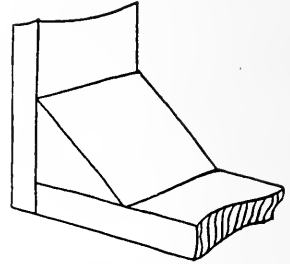

GLUED AND BLOCKED JOINT

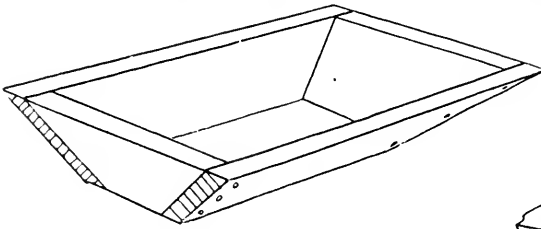

HOPPER JOINT

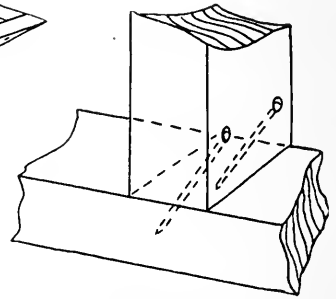

TOE NAIL JOINT

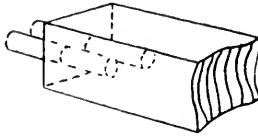
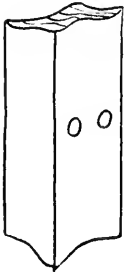

DOWELED BUTT JOINT

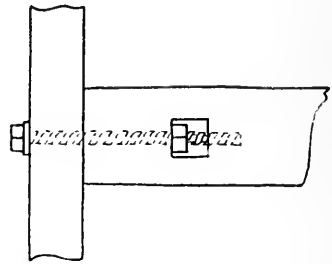

DRAW BOLT JOINT

FIG. 271.

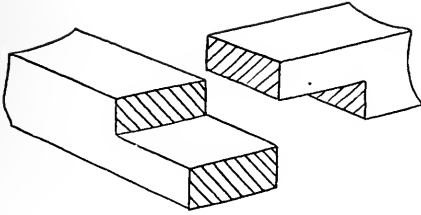

END LAP JOINT

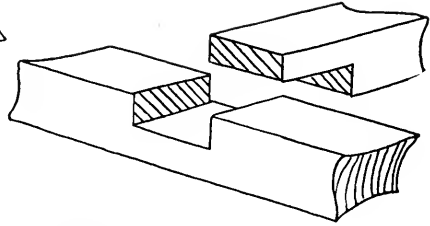

MIDDLE LAP JOINT

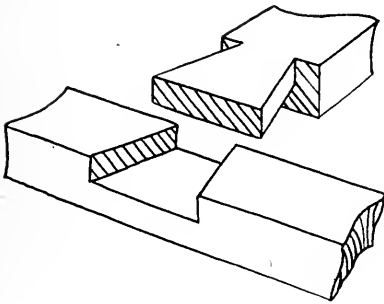

LAPPED DOVE-TAIL

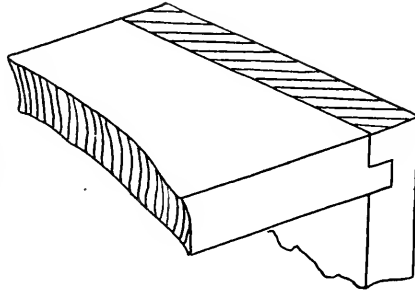

LEDGE OR RABBET

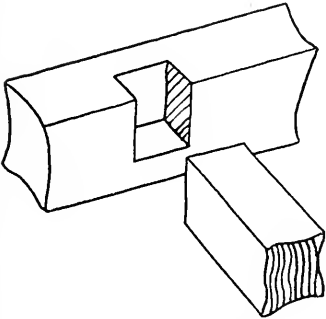

GAINED JOINT

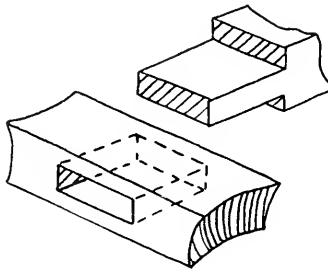

THRU MORTISE & TENON

FIG. 272.

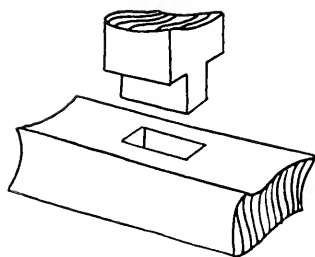

STUB MORTISE & TENON

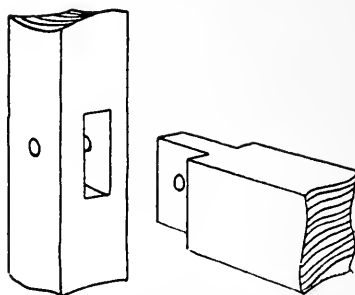

PINNED MORTISE & TENON

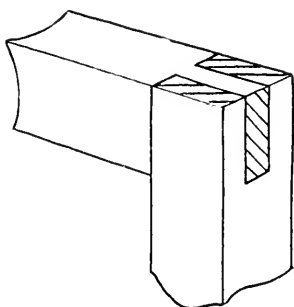

SLIP JOINT

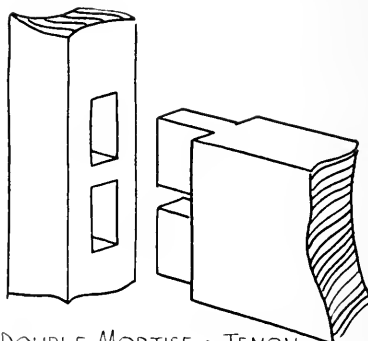

DOUBLE MORTISE & TENON

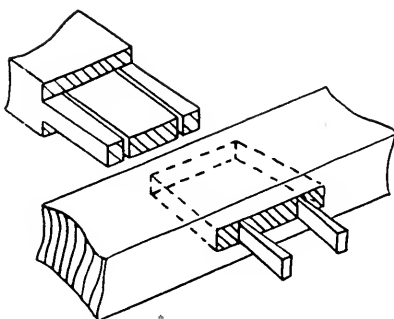

WEDGED MORTISE & TENON

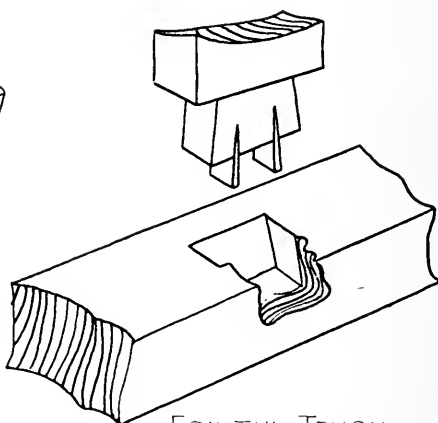

FOX-TAIL TENON

FIG. 273.

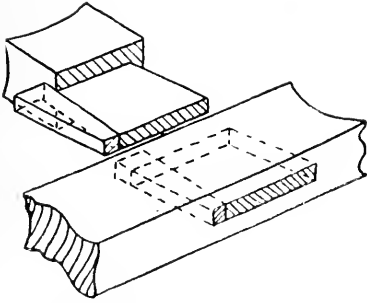

DOVE-TAIL MORTISE & TENON

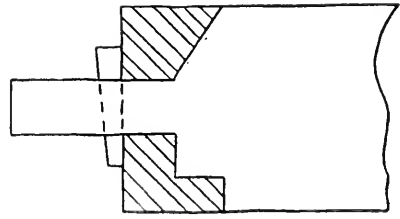

TUSK TENON

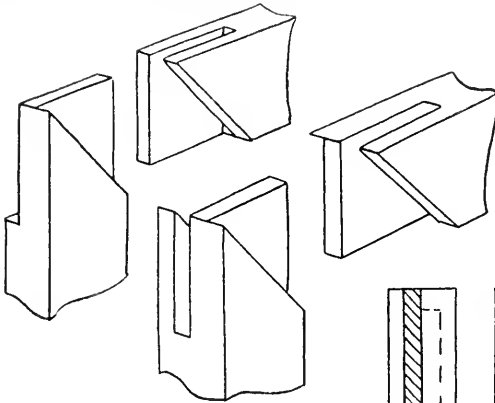

STRETCHER JOINT

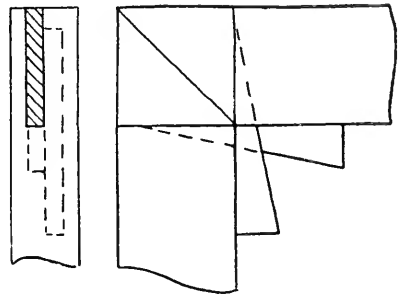

STRETCHER JOINT

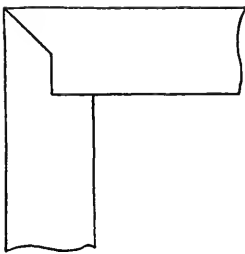

LEDGE & MITER

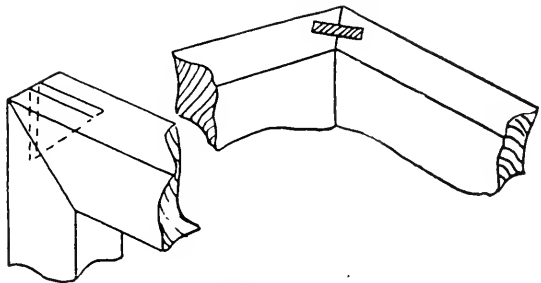

SPLINE MITER

FIG. 274.

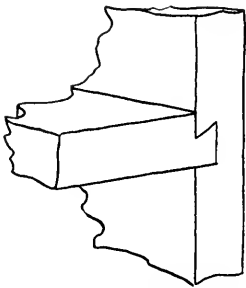

DOVE-TAIL DADO

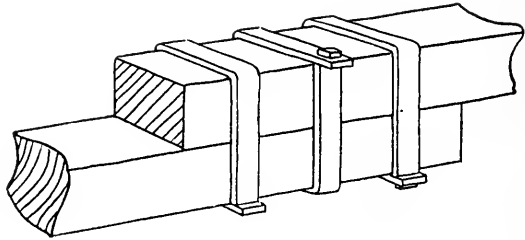

LAPPED & STRAPPED

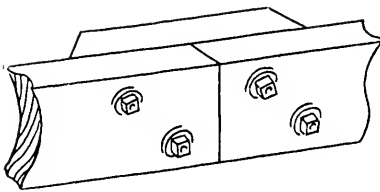

FISHED JOINT-A

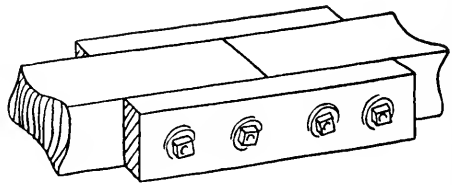

FISHED JOINT-B

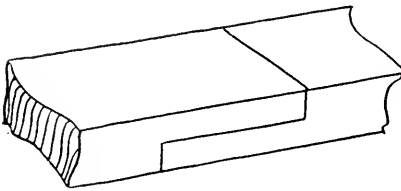

SPLICE JOINT

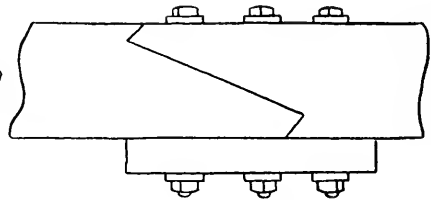

SCARF JOINT

FIG. 275.

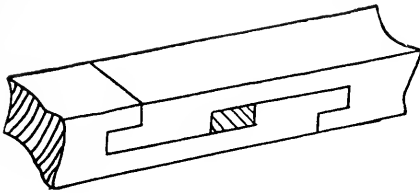

SPLICED JOINT

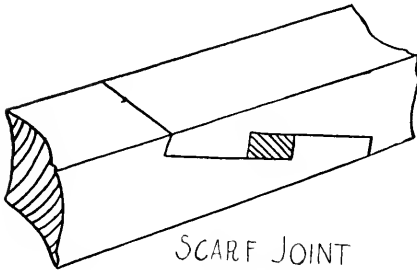

SCARF JOINT

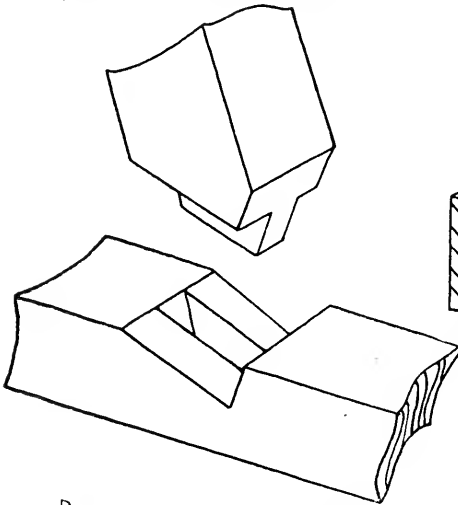

BEVEL-SHOULDER JOINT

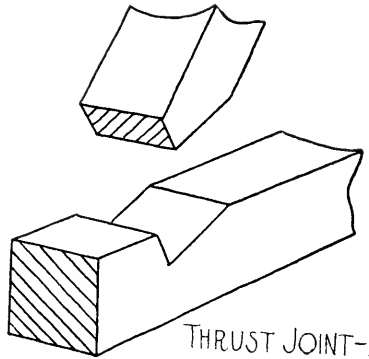

THRUST JOINT-A

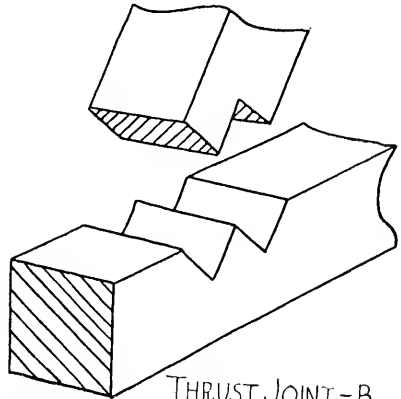

THRUST JOINT-B

FIG. 276.

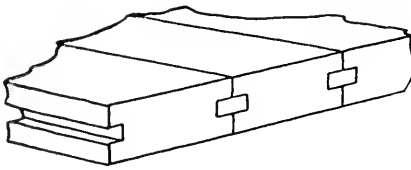

SPLINE JOINT

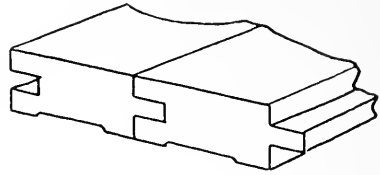

MATCHED JOINT

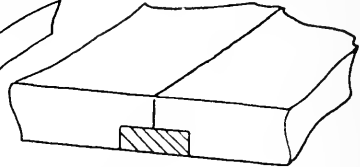
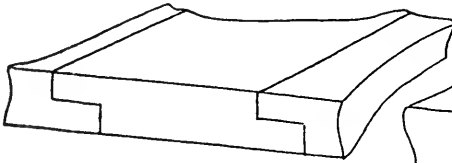

RABBETED & FILLISTERED JOINT

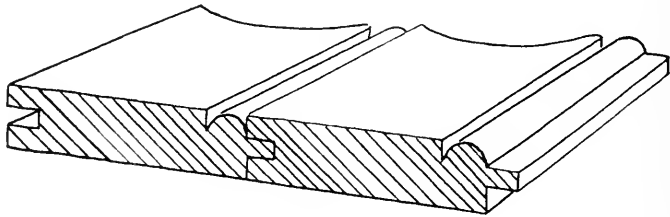

BEADED JOINT

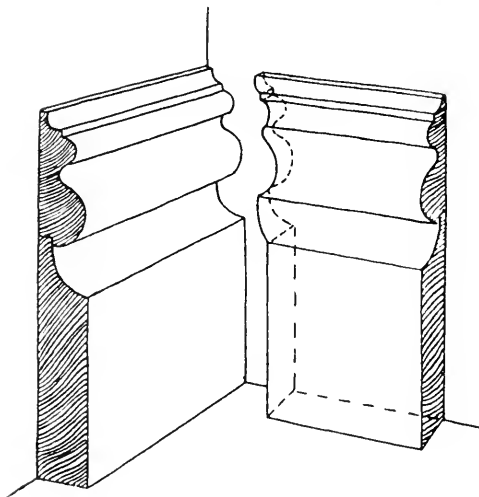

COPED JOINT

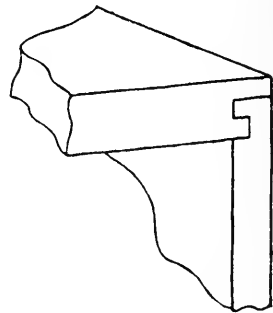

DRAWER CORNER

FIG. 277.

165. Hopper Joint.—The hopper joint is laid out and worked as follows: (1) Work the members to the proper width. (2) Plane the upper and lower edges to the proper bevel. The setting of the T-bevel may be obtained by setting it upon the drawing, Fig. 278. (3) Lay off the proper lengths and, with T-bevel and knife, score lines on the outer surfaces. (4) Square these lines across the upper and lower edges and connect on the inner surfaces. (5) Saw and plane to these lines.

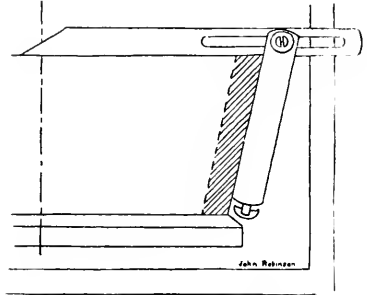

FIG. 278. SETTING T-BEVEL FROM DRAWING.

If the corner is to be composed of a miter joint instead of a butt joint, the miter square must be used in scoring across the edges, Fig. 279.

If the hopper is to have more than four sides, the miter across the edges will have to be laid out by means of the combination square or bevel protractor. In determining the setting of the tool, remember that the sum of all the angles about a point is 360° ; that the angle A, Fig. 280, in any regular polygon will be 360° divided by the number of sides possessed by the polygon. Again, the sum of the three angles of any triangle equals 180° ; therefore, angles B and B' being equal will be equal each to one-half the remainder obtained by subtracting angle A from 180° . This fact

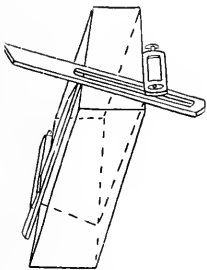

FIG. 279. BEVEL PLACED FOR MITERED HOPPER JOINT.

might have been expressed in a simple formula; the student may do this for himself.

The combination square, Fig. 40, makes possible any setting in degrees that may be desired.

It must be remembered that the method of laying out a hopper just described is applicable only where the edges are made parallel with the base.

The principle used in obtaining the angular measurement for a miter cut of a hopper of any number of sides applies with equal force to segmental work in carpentry, pattern-making and cabinet-work. In Fig. 281, for il-

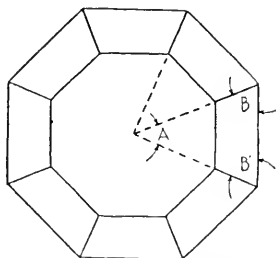

FIG. 280. CENTRAL ANGLE OF ANY POLYGON EQUALS $360^{\circ} \div N$.

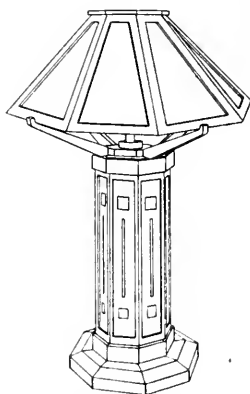

FIG. 281. TABLE LAMP.

lustration, the miters for the base, as well as the column, will be obtained in this manner. The shade is nothing more than a hopper inverted and may be laid out like a hopper.

The beginner may have observed that he has no way of testing a mitered edge on the shade except by means of the lines drawn across the top and bottom edges with the straight lines on the surfaces connecting these. That is, he cannot by the method described, determine a setting for his bevel or combination square for a test across a mitered edge with the beam on a face surface. It is possible to determine this angle, but it involves geometry

which the high-school boy will not have had in the early years. The method given will produce satisfactory results.

166. Doweled Joint.—In the construction of the doweled butt joint it is not always easy, because of the irregularity of the members, to locate centers by measurement. In such a case small brads may be driven into the end of one of the members and the heads snipped off so as to allow a protrusion of the remainder, of $\frac{1}{8}$ ". This member is then held in position relative to the second member and the points forced against the second member. Afterward the nails may be withdrawn, the holes forming the centers for boring.

Where many like members are to be doweled, templates or templets of tin or cardboard may be made of a shape which can be easily fitted to each member. Holes are punched in this templet as desired; pricks with an awl thru these holes locate boring centers.

Still another method consists in turning on the lathe dowel markers, Fig. 282. By having a variety of sizes with the centers accurately placed, time may be saved over the methods just described. To use this marker, bore the holes in one of the members, insert markers of proper sizes and then press this member against the second member.

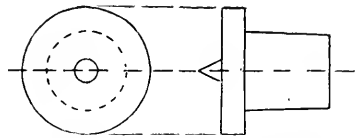

FIG. 282. DOWEL MARKER.

167. Pinned Mortise-and-Tenon.—In making the pinned mortise-and-tenon, the hole in the member containing the mortise is laid off by measurement. The hole in the tenon for the pin is also laid off by measurement but with this difference—it is drawbored. This consists in locating and boring the hole in the tenon slightly nearer the shoulder of the tenon than the

measurement of the hole thru the mortise would suggest. The purpose of drawboring is to insure the mortised member being pulled up snugly against the shoulders of the tenoned member. The amount of offset in drawboring is determined by the size of the members. In barn framing, where a tenon would be 2" thick by 6" wide by 6" long, the center in the tenon for the pin hole is drawn toward the tenon shoulder about $\frac{3}{32}$ ".

168. Coped Joint.—In fitting one irregular member against another the mitered joint is not always satisfactory. A more frequent form is the coped joint. This form of joint is especially suited to internal angle work, as in placing base boards and base mold.

To form this joint, (1) saw the ends of one member square and fit snugly to the corner just as if no other member were to be fitted there. (2) Place the second member in the miter-box and saw the end which is to fit into that corner, mitering with the bevel or slope on the face of the molding. The intersection of this slope or bevel with the face of the molding indicates the line along which the molding is to be "backed." Backing consists in cutting away the beveled surface straight across the molding with a slight undercut to insure the faces fitting. (3) This backing is best done with a fine-bladed coping saw.

CHAPTER V.

WOOD-TURNING.

169. **Turning Between Centers.**—Stock used in turning between centers should be approximately square in cross-section. Should the stock be much greater than three inches square it is safer for beginners to remove the arrises, thus forming an octagonal section, before beginning to turn.



FIG. 283. CENTERING STOCK BY DIAGONALS.

170. **Centering the Stock.**—(1) To center stock, either square or rectangular in section, draw the diagonals on each of the two ends, Fig. 283. Stock which is irregular in cross-section is scribed as in Fig. 284. The dividers are set to the approximate distance of the center from any one side and the end scribed as shown. If no plane table is near upon which to lay the stock in scribing, the same result may be accomplished by dropping the one point of the dividers over the arris along which the scribing is being done, stock and dividers being held freely in the hands, Fig. 285. (2)

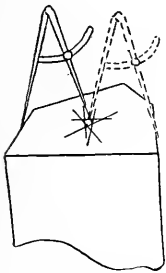

FIG. 284.
CENTERING
IRREGULAR
STOCK.

Place the stock on the live or spur center. The most common way of doing this consists in placing the center of the end, as indicated by the intersection of the diagonals, against the spur center and driving against the other end of the stock with a mallet until the spurs

penetrate the wood to a depth of about $\frac{1}{16}$ ". In hard wood, a seat must be made for the spurs or spur center. This is done by making a saw kerf along each of the diagonals or by boring a small shallow hole at their intersection.

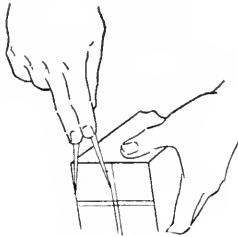

FIG. 285.
CENTERING STOCK.

A second method of placing the block on the live center differs from this one only in that the pounding is done off the lathe, a special live center being kept for this purpose, the pounding being done on the center instead of on the block or stock. The advantage of this latter method consists in its saving the lathe head and bearings the jar of the blows struck by the mallet on the end of the stock. The disadvantage lies in the fact that spur centers are seldom exactly alike and, for accurate work, it is best to make use only of the spur marks of the center which is to be used on that particular lathe. (3) After the live centers are once set in the end of the stock, so mark the center and the end of the stock that, should it become necessary at any time to remove and replace the stock, the spurs may be given the same relative positions. This is especially advisable where stock is removed between class periods to be replaced at the next period.

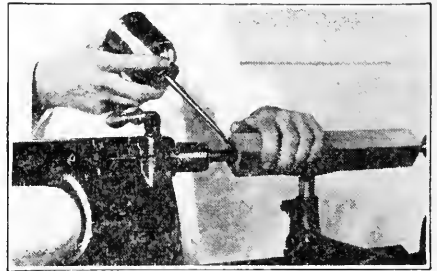

FIG. 286. OILING DEAD CENTER.

It is essential, of course, that centers be marked and kept only on the lathes for which they are marked. (4) Draw the tailstock up to within several inches of the stock and fasten it to the lathe bed firmly by means of the tailstock

clamp. (5) Screw up the dead spindle until the cup-center has been forced into the wood a good $\frac{1}{32}$ ". (6) Withdraw the cup-center slightly and place a few drops of lubricating oil on it and the wood, Fig. 286. The oil might have been placed on the end of the stock before its insertion in the lathe. (7) Rotate the stock several times by revolving the cone pulley, before throwing on the power. Otherwise the binding of the stock may throw the belt off. As a further precaution, take hold of the belt and see if the

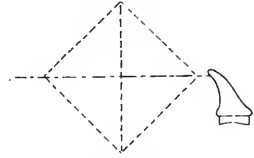

FIG. 287.

ADJUSTING TOOL REST
FOR HEIGHT.

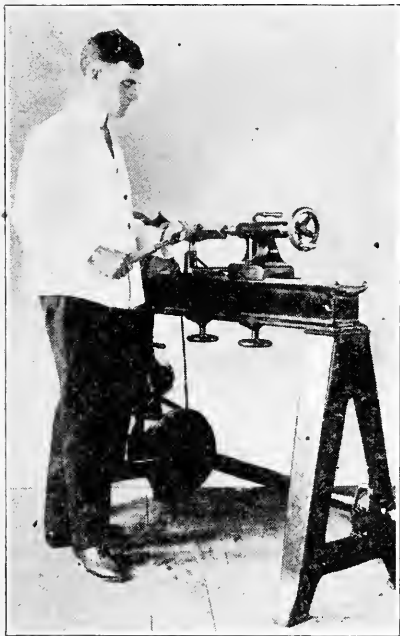

FIG. 288.

POSTURE AT THE LATHE.

stock will revolve without the belt's slipping. If it does not, release the dead spindle slightly and try the belt again. It may be necessary to unscrew the spindle slightly again before the wood will revolve freely. (8) Adjust the spindle clamp carefully.

171. Adjusting the Tool Rest.—Before power is turned on, the tool rest must be clamped in a safe position, Fig. 287. A lathe has a maximum speed of about 3,000 R. P. M., and a loose rest at any time is a dangerous thing. Never attempt to adjust a rest with

the lathe in motion, and uneven stock between centers. Stop the lathe.

Adjust the rest so that its top is slightly above centers, about $\frac{1}{8}$ " to $\frac{1}{4}$ ", keeping it parallel to the stock to be turned, and about $\frac{1}{8}$ " away from the farthest projecting arris on the stock. The height of rest is governed by the height of the worker relative to the lathe. An easy position is the controlling factor. Revolve the stock by pulling the belt or moving the cone to see that the rest is safely placed. Throw the power on slowly, giving the lathe an opportunity to "speed up" before applying full power.

172. Position of the Operator.—The position of an operator at a lathe should be one that will produce facility, stability and comfort. Fig. 288 illustrates a good position in general. The feet should be well apart to give stability. The tool rest, if the adjustment above center is too high or too low to allow the hand to rest comfortably beside the body, should be changed. The body should be turned slightly so that the left side of the worker is a little nearer the lathe than the right.



FIG. 289. POSITION OF HANDS ON GOUGE—FIRST POSITION.

173. Use of the Large Gouge.—The large turning gouge is used for making the first or roughing-off cuts. It is also used to reduce the cylinder to its approximate diameter. The lathe should be run on low speed until the arrises are removed and the cylindrical form obtained.

With the handle of the gouge held firmly, but not rigidly in the right hand, against the body; and the

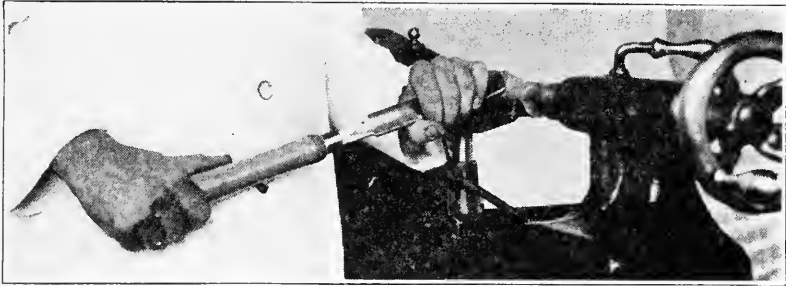

FIG. 290. POSITION OF HANDS ON GOUGE—SECOND POSITION.

left hand against the rest, and grasping the blade, as in Fig. 289, with the wrist dropped to allow the hand to act as a sliding guide along the rest, the fingers encircling the tool; push the tool slowly toward the revolving stock. Begin the cut somewhere near the middle of the length of the stock and carry the tool along and out beyond the end. Next, holding the tool as in Fig. 290, work toward the

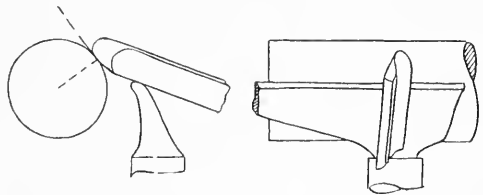

FIG. 291. CORRECT POSITION OF GOUGE IN ROUGHING OFF.

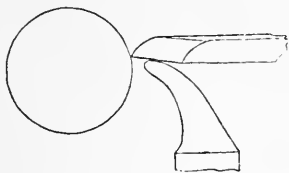

FIG. 292. INCORRECT POSITION OF GOUGE IN ROUGHING OFF.

second end. Continue in this manner until the stock has been reduced to within $\frac{1}{8}$ " of the final diameter.

The gouge, like other edged tools, works best when held so as to produce a shearing cut. This is secured by rolling the blade slightly on the rest as in Fig. 291, and holding the cutting edge high up on the cylinder. When turning toward the other end of the stock the gouge is rolled in

the opposite direction. Fig. 292 illustrates a position often assumed by beginners. This position of the tool causes it to scrape instead of cut and the edge to be dulled in a short time. If a gouge is properly ground the cutting angle is not obtuse enough to serve as a scraping edge.

Once a cylindrical surface has been formed, a quick way to locate the position of the gouge with reference to the revolving surface is to place the tool with its bevel or grind rubbing the wood, then gently lift the right hand until the edge begins to cut, after which it is to be moved to the right or left slowly and uniformly.

To prevent a "bite" (the catching of the tool in the wood so as to throw the tool out of position and a piece out of the stock) see that the tool is resting firmly upon the toolrest before attempting the cut. Also see that the rest is moved to within $\frac{1}{8}$ " of the cylindrical surface after the arrises have been removed from the square. These precautions, with the cutting edge properly placed, ought to prevent trouble.

174. Use of the Outside Calipers.—Until the beginner has secured a slight mastery of his tools he can hardly

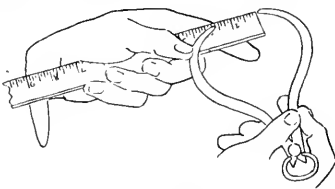

FIG. 293.

SETTING THE CALIPERS.

be expected to work to a fixed and final dimension. He should, however, begin quickly to make an effort to work to a fixed or predetermined dimension. After the arrises are removed he should set the calipers as in Fig.

293 to a dimension somewhat smaller than that of the cylinder just obtained and practice reducing the cylinder to this dimension with a smooth surface from end to end of the project. The skew should be used for this smoothing. Caliper the cylinder as the work progresses. Woodturners caliper while the stock is revolving, by holding

the instrument at right angles to the line of centers, touching the work lightly and carefully so that the leg of the caliper on the near side may not be carried over the diameter thru friction. The beginner had better stop his lathe to do this calipering, Fig. 294. In no case should the calipers be forced over the work, but the work should be reduced until they may be passed over the diameter without any pressure whatsoever, just touching at both legs.

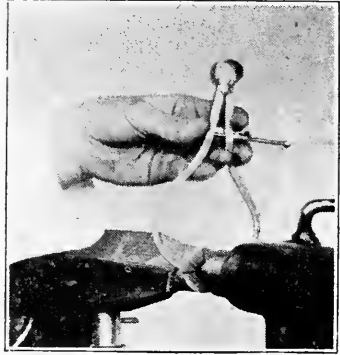

FIG. 294.
CALIPERING THE STOCK.

After the worker has repeated this operation several times and finds he can work to a calipered diameter with some degree of assurance, he should set his calipers for the final diameter and work to the same.

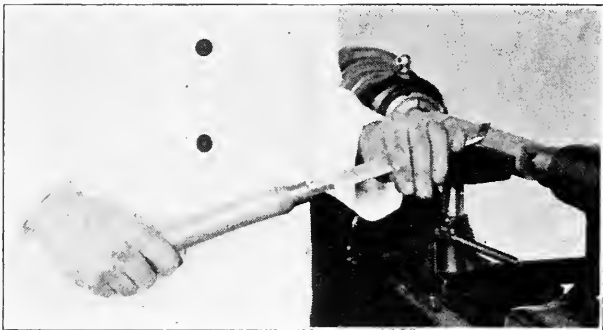

FIG. 295. USING LARGE SKEW—FIRST POSITION.

175. Use of the Large Skew.—The large skew is to be held as in Figs. 295 and 296. This tool is to be used to smooth the surface of a cylinder after the gouge has roughed it off. Fig. 297 shows in greater detail this tool when in cutting position. Begin the cut several inches

from an end and carry it toward and out over the opposite end. Never begin right at an end or the tool will catch in the wood and split it or possibly throw the tool from the hands of the worker.



FIG. 296. USING LARGE SKEW—SECOND POSITION.

The simplest way to get the skew in proper cutting position is (1) to lay it flat upon the tool rest and upon the cylinder with the cutting edge safely above the cylinder's surface, Fig. 298-a. (2) Allowing the tool to slide freely thru the left hand, draw the right hand and the tool down and back gradually until it has a position similar to that in Fig. 298-b. (3) Swing the right hand and the

tool to the right or the left, Fig. 297, front view, depending upon the direction the cutting is to take, and (4) lift the hand slowly until the edge begins to cut, Fig. 298c. (5) Holding this position move the tool slowly

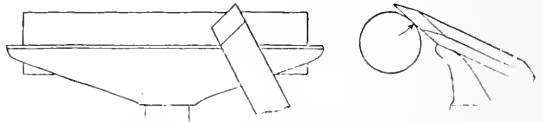

FIG. 297. DETAIL OF POSITION OF SKEW.

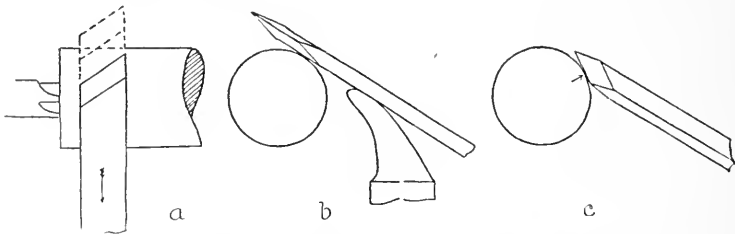

FIG. 298. SUCCESSIVE PLACINGS OF SKEW FOR POSITION.

and uniformly along the rest and the cylinder. Do not move the feet but let the body move, with the ankles as pivots, in the direction of the cutting.

The secret of safe cutting with the skew lies in maintaining the angles just suggested with reference to the front and side views, and in raising the handle just sufficient to allow the edge to cut without further raising the heel of the bevel or grind from the surface of the wood. To raise the handle higher is to remove the heel from contact with the surface of the cylinder and thereby destroy the working fulcrum used in regulating the amount of cut, resulting in a "bite." Obviously, if the cutting at any time is becoming too deep the edge may be raised and the cut made shallower by lowering the right hand and the tool handle a little.

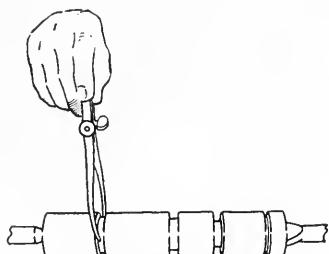

FIG. 299. PARTING TOOL CUTTINGS FOR DIAMETER.

176. Cutting Off; Use of Parting Tool.—The parting or cutting-off tool is used for two purposes: (1) with the aid of calipers, to determine quickly the approximate diameters desired for a part or parts of a piece of spindle turning, Fig. 299; (2) to part or cut off the stock at any



FIG. 300. USING THE PARTING TOOL.

desired point. In either case the manipulation of the tool is the same.

This is a scraping tool. When so used the blade is

held in a horizontal position, the narrow edge upon the rest and the point of the tool a little above the line of centers. The tool is pushed forward into the stock, Fig. 300.

The $\frac{1}{4}$ " scraping tool may be used in a similar manner for this same purpose. In using this tool it is advisable to make the groove slightly wider than the tool to prevent its heating thru friction.

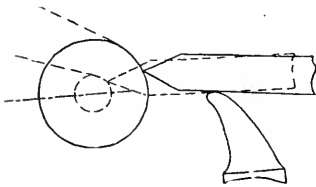

FIG. 301. DETAIL OF PARTING TOOL POSITIONS.

The parting tool will make more of a cutting and less of a scraping action if held as in Fig. 301 with the lower bevel more nearly tangent to the surface at the bottom of the cut. This will necessitate starting the cut with the handle low and raising it as the point of the tool approaches the center of the cylinder.

In cutting to length, leave $\frac{1}{16}$ " between the line and the groove made by the cutting-off tool, to be dressed up later by means of the small skew.

In laying off lengths, see that enough stock is left at the live center to insure the parting tool's not striking the revolving spurs. If enough stock is left, the parting tool may be inserted so as to leave a $\frac{3}{8}$ " diameter; this may be reduced still further when the main part of the turning has been completed and the greatest strain removed.

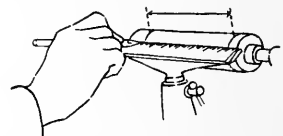

FIG. 302. LAYING OFF SUCCESSIVE MEASUREMENTS.

Fig. 302 illustrates the manner of laying off lengths. A very sharp pencil is held at the desired point as indicated by the rule and pressed gently against the revolving stock.

177. **Use of the Toe of the Skew to Dress Off an End.**
 —The small skew is to be used in dressing off the end of the cylinder after the parting tool has prepared the way. Hold the tool as in Figs. 303 or 304. The essential thing in this operation is that the grind or bevel of the skew adjacent the end being cut, shall lie very nearly parallel

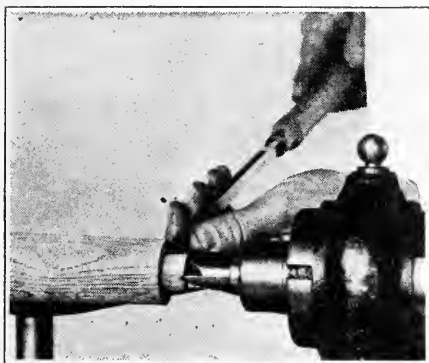

FIG. 303. USE OF SMALL SKEW
 IN SQUARING END AT
 LIVE CENTER.

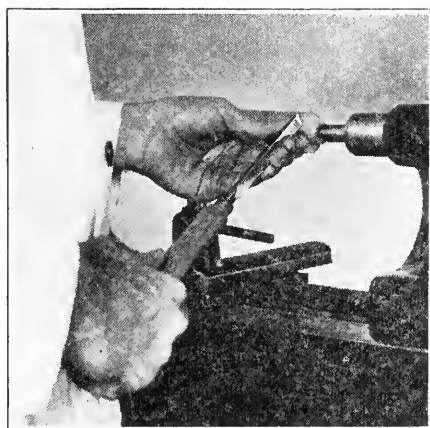

FIG. 304. USE OF SMALL SKEW
 IN SQUARING END AT
 DEAD CENTER.

to the end surface of the cylinder. There should be just enough inclination from this plane to allow the toe of the skew to cut, with the heel of the grind so placed against the surface of the cylinder that it may be used as a fulcrum in manipulating the cutting edge of the toe of the skew when striving for light or heavy shaving. Care must be taken in using the heel of the grind as a fulcrum not to allow the cutting edge on the heel of the skew to come in contact with the surface of the cylinder end, or a "run" will result. The forces involved here are somewhat subtle and the student will need to

exercise patience with careful thought. In Fig. 305 is shown in detail the position of the skew and the direction of movement in the vertical plane taken to keep the cutting edge of the skew toward the center of the cylinder. About $\frac{1}{32}$ " should be taken at each cut.

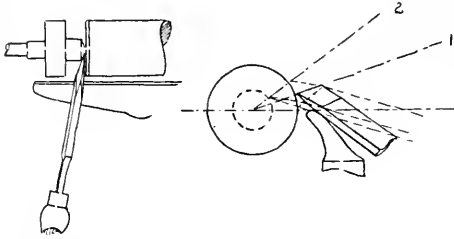

FIG. 305. DETAIL OF POSITION OF SKEW AND DIRECTION OF MOVEMENT IN SQUARING AN END.

The end of the cylinder may be the more completely surfaced with the skew if some more of the waste stock is removed as in Fig. 306. This half V-cut is made by inclining the skew so that the grind or bevel farthest removed from the end surface of the cylinder shall parallel the proposed surface of the V with just sufficient variation to cause the toe of the skew to cut, and still prevent the heel from catching. The heel of the grind, as heretofore, serves as a fulcrum. This V-cut is made after each end cut, which is forced below the surface of the end slightly, until the diameter on small projects is reduced to about $\frac{1}{8}$ " at the live center and slightly less at the dead center. The amateur had better stop the lathe and remove the waste ends by means of the chisel or a knife, after securing the instructor's permission. An experienced lathe man would spread his left hand about the project and, inserting the chisel with the right hand, would cut the cylinder free at the live end while the lathe is in motion.

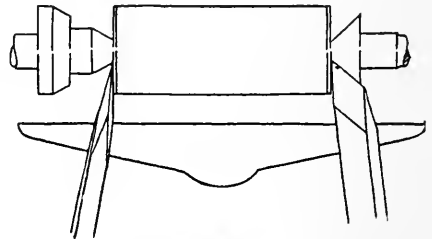

FIG. 306.
REMOVING WASTE STOCK.

178. Heel of the Skew Used to Cut to a Shoulder.—

In the forming of a shoulder the vertical cuts are made as just described in the preceding section. The horizontal cuts, however, while made with the skew, differ somewhat from those used in plain cylinder surface work. The skew is placed upon the tool rest in the manner described for the starting position of the skew in plain surface work, the heel toward

the shoulder, and then the blade is drawn down and back until the heel is over the point of tangency between the skew and

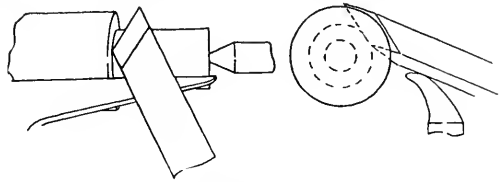

FIG. 307.

CUTTING SHOULDER WITH SKEW.

cylinder. When this position is secured the handle of the skew is raised and moved to the right or left just enough to allow it to cut lightly as the tool is moved along the rest. Fig. 307.

179. Long Taper Cuts.—The large gouge is used in the usual manner to rough out the approximate shape of the taper. The skew is used to smooth this surface in a manner quite similar to its use on plain cylinder work, but with one important difference—the taper cut is begun with the heel of the skew, the skew being held as in cutting to a shoulder horizontally. After the taper has been started, the skew may be drawn a little farther down and back, until the cut is being taken at the usual point of contact in large skew surface smoothing, Fig. 297. Or, if one prefers, the full length of the taper may be cut with the skew held as in the starting position, with the heel alone. In cutting with the heel alone one must be watchful that he does not take a deeper cut in the middle of the length of the taper than he intended. The heel enters so readily that the beginner might better strive for a

shallower depth at the middle than he realizes he has need of. The cutting must take place from the shallower toward the deeper part of the taper cut always, of course.

180. Laying Off Consecutive Measurements.—Where a number of like spindles are to be turned, consecutive measurements are best transferred to the stock from a piece of thin wood or from cardboard with a straight edge, the measurements having been previously placed along the edge with a sharp pencil or an awl. A more per-



FIG. 308. CUTTING V-GROOVES.

manent templet, and one from which the measurements are more quickly transferred, is obtained by driving small brads into the edge of the wood at the points required, snipping off the heads and filing the projecting ends to sharp marking points. This templet is pressed against the revolving stock insuring similar markings for the various pieces to be turned.

181. Making Full V-Grooves.—A little experience will have been obtained in the use of the skew in the making of the semi V-grooves in dressing off the cylinder ends. In full V work, it is much better to make use of the heel of the skew, the small skew being used. When the heel is used the cutting edge is better sup-

ported on the grind or bevel and a shearing cut is obtained.

(1) Hold the blade between the thumb and the last three fingers, Fig. 308. (2) The dimensions having been previously laid off on the stock, a rather deep cut is made with the heel of the skew on the line which indicates the proposed bottom of the depression. In making this cut care must be taken not to burn the cutting edge by too continuous a pressure. (3) The side or bevel of the V is begun with the extreme obtuse cutting angle of the heel, Fig. 309. Only one-half of the V should be cut at a time. With

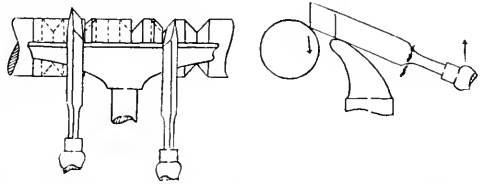

FIG. 309. DETAIL OF CUTTING V-GROOVES.

the completion of this half the remaining half may be cut down by reversing the position of the chisel. By this method of cutting the junction of the two surfaces of the V will be true to measurement.

In cutting V's it will be found easier if the skew is given a "pump handle" or "hinged" movement as indicated by the arrows in Fig. 309. This movement consists in placing the tool well up on the work and, using the rest as a fulcrum, raising the handle until the heel of the skew enters the surface to the depth wanted. As in all other cutting with the skew, the grind or bevel next the surface being cut must be used as a fulcrum by which to regulate the depth of the cut, without, at the same time, allowing the full edge to catch and cause a run. It must be remembered that a point will not "run," either heel or toe; it is only when the entire cutting edge is allowed to become engaged that trouble ensues. Yet, on the other hand, the tool must not be placed so as to

engage too little of the point by throwing the grind too far from parallelism with the surface being cut, for then a smooth surface would not be possible nor would there be sufficient bearing of the heel of the grind to serve as a fulcrum in guiding the point. This balance must be learned by practice, but a careful analysis and understanding of the facts will aid wonderfully.

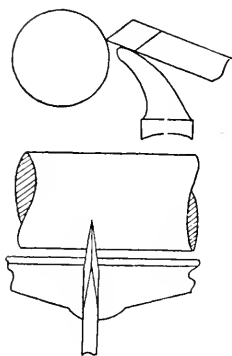

FIG. 310. USING TOE OF SKEW IN MAKING PREPARATORY CUT.

182. Short Convex Cuts; Beads.— In turning short, convex curves or beads, (1) a deep vertical cut is made at the place the two curved surfaces will eventually roll together. The manner of making this cut is identical with that used in making the first vertical cut preparatory to making the V-groove. Also this cut may be made by inserting the toe of the skew as in Fig. 310. (2) With the length of the tool at right angles to the line of centers, place the small skew flat upon its side and well up on the cylinder and rotate the blade, cutting with the heel, until it assumes successively the positions indicated in Fig. 311. As the curve is being cut, the tool must be drawn backward as shown by its position on the stock at the beginning and at the end of the cut.

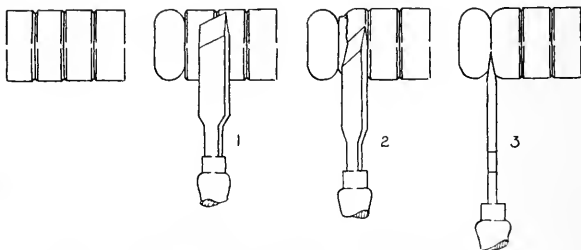

FIG. 311. MAKING SHORT CONVEX CUTS.

This is done to permit the grind to maintain its tangency with the curve. The positions of the hands in this work

are similar to those assumed in the making of V-grooves, Sec. 181.

183. Concave Cuts.—Short concave curves are made with the small gouge, the hands being placed upon the tool and rest as described in Sec. 181. It is very essential for proper concave cutting that the gouge be properly shaped; the student is referred to Sec. 84 for information as to the proper shape of the cutting end.

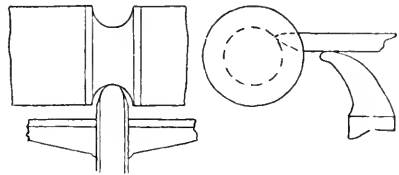

FIG. 312.

STARTING SHORT CONCAVE CUT.

(1) Rough out the approximate shape of the cut by pushing the gouge, while lying on the rest in a horizontal position with the hollow uppermost, into the wood well within the lines limiting the sides of the cut, Fig. 312.

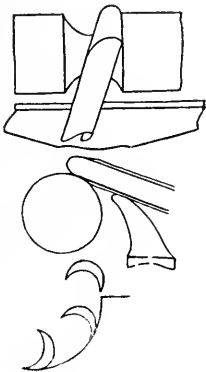

FIG. 313.

MOVEMENT OF
GOUGE IN SHORT
CONCAVE CUTS.

(2) Roll the tool over until the grind is at right angles to the surface of the wood with one lip touching the wood, Fig. 313.

(3) Roll the tool until it assumes the position shown in Fig. 314. The effect of this rolling should be to bring the grind against the surface already cut and thus make this grind serve as the fulcrum by means of which the cutting edge of the gouge may be regulated as to depth of

cut. (4) The gouge is pushed forward as it is rolled over, being directed toward the line of centers. (5) Cut with the grain only, that is, cut to the bottom of the groove only and reverse the position of the tool to cut the remaining arc. (6) Cut alternately, beginning each cut at the surface of the cylinder, and continue until the limit

lines are reached. (7) The accuracy of the arc may be tested by placing the square as in Fig. 315.

184. Long Convex Cuts.—To turn spindle forms involving long convex curves, (1) rough off the stock to the largest diameter, using the large gouge. (2) Lay off the longitudinal dimensions upon this cylinder. (3) With the parting tool determine the diameters. (4) Rough out with the large gouge. (5)

Finish with the small gouge. Place the thumb in the hollow and encircle the blade with the three fingers, the index finger being hooked under the tool rest and the blade firmly upon the rest. (6) Make the cut with the lip of the tool and keep the grind tangent to the surface being cut, quite like that observed in concave cutting. Swing the handle in the direction of the cutting that this tangency may be maintained, Fig. 316. The skew might have been used for this work.

185. Face-Plate and Chuck Work.

—In face-plate and chuck turning, the scraping tools

are made use of because the cutting tools would be certain to catch and "run." This difference is due to the fact that in face-plate and chuck work the stock is placed

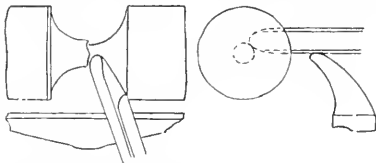

FIG. 314. FINAL POSITION OF GOUGE IN SHORT CONCAVE CUTS.

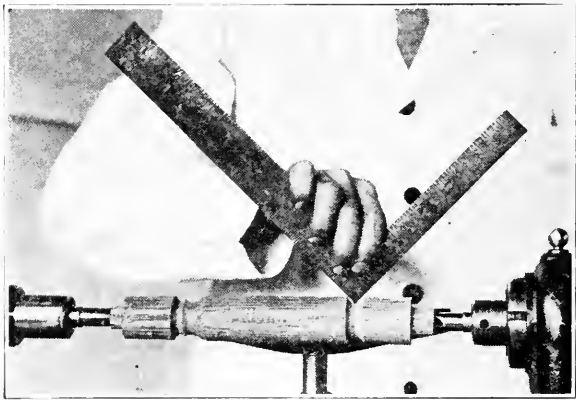

FIG. 315. TESTING CONCAVE CUT.

in the lathe with the grain of the wood extending at an angle with reference to the line of centers, entirely different from that which it has in spindle turning, as a rule.

The skew and gouge used in spindle turning might be made use of for scraping in face-plate and chuck work. It is better, however, where the expense of the additional tools is not an item, to make use of the scraping

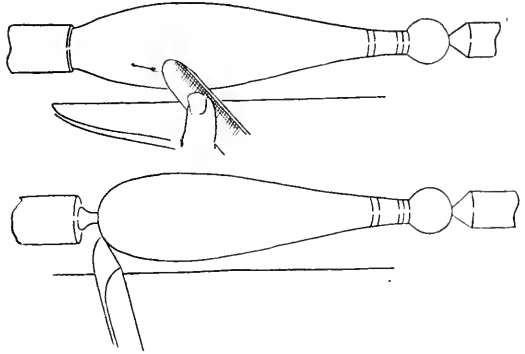

FIG. 316. LONG CONVEX CUTTING.

tools described in Sec. 46. The cutting wedge of the skew is not obtuse enough to withstand the effect of scraping and remain in condition for further effective spindle turning. Then, too, a scraping tool cuts best when given a scraping burr, a thing which would ruin a skew for spindle work.

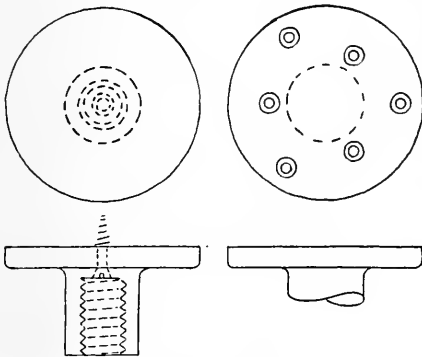

FIG. 317.

FACE PLATES—CENTER SCREW
AND SURFACE.

186. Face-Plates; Preparation of the Stock.—Each lathe is, as a rule, provided with several face-plates. These should be numbered to correspond with the number of the lathe to which they belong and should not be used on any other lathe.

The center screw face-plate has a fixed screw at its center. This is for use with stock 4" in diameter or under. For stock of greater diameter a surface plate must be used. The surface face-plate has holes drilled at

various places over its face, thru which screws may be inserted, then into the stock. There is usually a hole in the center of the surface face-plate thru which a screw may be inserted, making it equally suited for center screw work, Fig. 317. When turning stock with a diameter of from 4 to 6 inches, the second speed should be used for roughing off and the highest speed for finishing. For stock with a diameter over 6 inches, the slow speed should be used for roughing off and a second or third speed for finishing.

For both large and small face-plate turning it is safer to remove the surplus stock, the corners, before attaching the piece to the lathe. (1) With the dividers describe a circle somewhat larger than the finished diameter is to be, about $\frac{1}{8}$ " larger. (2) Saw to this line, making use of the band-saw, or the bow-saw if no band-saw is available.

(3) If the stock is of soft wood and under four inches in diameter, place the center screw face-plate on the lathe and then attach the stock to the center-screw by pressing firmly upon the wood while turning it. If hard wood is to be used, a small hole must be bored so that the core of the screw may enter. This method of fastening stock to the face-plate is appropriate, of course, only where the project is of such shape that the center screw will not interfere with the work of turning, and on small work. The center screw may be used upon larger work but an additional screw, or screws must be made use of. Where screws are inserted thru the plate other than at the center, care must be taken to place them so that they will not come in contact with the scraping tools while turning. The surface of the stock which is to come in contact with the face-plate must be planed true before attaching it. The reason is obvious.

Where it is necessary to cut entirely thru a piece of stock that is fastened to a face-plate it is necessary to "back" the stock by the insertion of a piece of stock, usually about $\frac{1}{4}$ " in thickness, between the face-plate and the stock. In some cases this backing is surfaced true on only one side; then this side is fastened to the face-plate and the second side surfaced with the scraping tools. This backing allows the tool to cut entirely thru the project without coming in contact with the metal of the face-plate, Fig. 318-a. Backing is also used where the project to be turned is too thin for the insertion of screws, or where it is desired to increase the working surface of the face-plate. Fig. 318-b and c. In the first case the screws are inserted entirely thru the backing and then into the project, holes being bored thru the

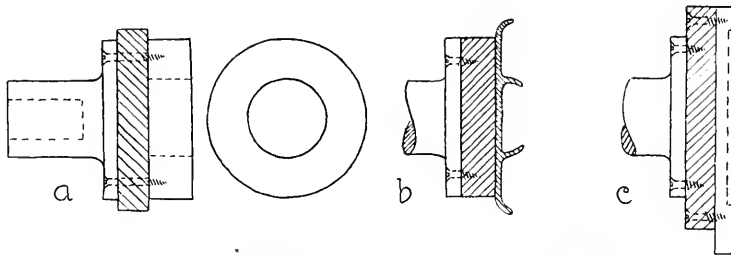

FIG. 318. BACKING FOR FACE-PLATE WORK.

backing at places appropriate to the screw holes in the face-plate, the shape of the project being considered in determining which holes in the face-plate shall be used. In the second case the screws are inserted in the backing only, the project being glued to the backing after the backing has been faced off. The manner of fastening the third type is clearly indicated in the drawing.

For accurate face-plate turning there should be no end "play" in the live spindle. All good lathes are made with adjustable bearings and, should the student find he

can move the cone and spindle endwise in the headstock, he should report the matter to his instructor for directions as to the remedy.

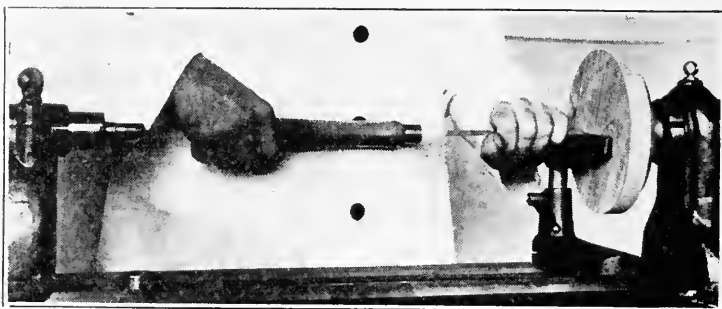

FIG. 319. FACE-PLATE WORK.

187. **Rough Scraping.**—(1) With the stock to be turned upon the face-plate and in the lathe, the tail stock well out of the way, move the tool rest to within $\frac{1}{8}$ " of, and as nearly parallel to, the surface to be turned as possible, Fig. 319. The tool rest should be raised to such a level that the operator cuts along a horizontal line passing thru the center of the revolving stock. (2) Use

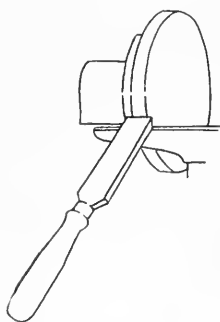

FIG. 320. TURNING
TO DIAMETER.

the wide square-nosed scraping chisel, holding it in a horizontal position. Begin at the center and move it toward the left slowly and uniformly. (3) Test the face by placing a straight-edge across it. (4) The corners having been previously cut off, the diametral dimension may next be secured. Figs. 320 and 321 illustrate two different methods. In the first, the rest is swung around as in spindle turning and the edge is scraped by means of the broad square-nosed chisel. In Fig. 321, the tool rest is swung at an angle with reference to the line of centers and the spear

point tool is made use of, being held so that one of its scraping edges shall move at right angles to the line of centers, or square across the stock. (5) Care must be taken in all center-screw face-plate turning not to allow the tool to "dig," and not to scrape too strongly, or the project will be turned up on the screw so that the wood screw threads will be destroyed, and the stock will fall from the lathe.

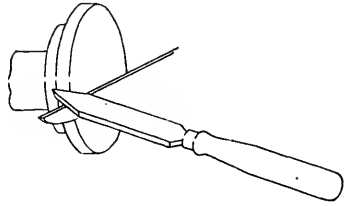

FIG. 321. TURNING TO DIAMETER—SECOND METHOD.

188. **Convex and Concave Scraping.**—Convex surfaces, such as beads, are best scraped by means of the square-nosed chisel or else the spear point, Figs. 322 and

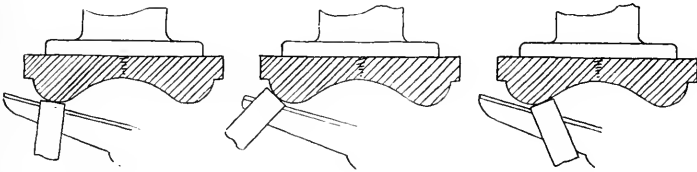

FIG. 322. CONVEX SCRAPING WITH SQUARE NOSE SCRAPER.

323. The direction of movement of the tool is indicated in the drawing, the movement being either to the right or to the left as required.

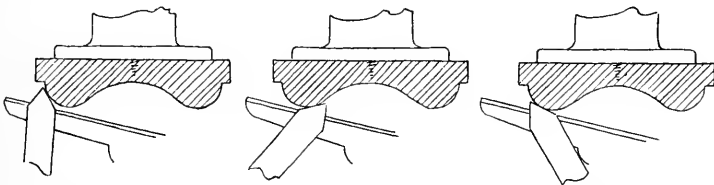

FIG. 323. CONVEX SCRAPING WITH SPEAR-POINT CHISEL.

In concave scraping the round-nosed tool is to be used. This is forced into the wood to the approximate

depth and then worked to the right and to the left, working from the deepest part out, Fig. 324.

189. **Chucks; Their Use.**—The processes of turning and scraping so far described, presuppose projects of such construction that there will be surfaces into which screws may be fastened without injury to the completed result. There are some kinds of work, however, which must have both surfaces or edges worked with the lathe tools. Rings, spheres, etc., are standard examples. With such projects, chucks must be made use of. Chucks are no more nor less than pieces of soft wood, such as white pine, so shaped that the partially turned project may be held thereby and the rest of it turned without injury.

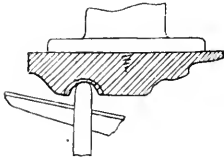

FIG. 324.
CONCAVE SCRAPING.

Rings, spheres, etc., are standard examples. With such projects, chucks must be made use of. Chucks are no more nor less than pieces of soft wood, such as white pine, so shaped that the partially turned project may be held thereby and the rest of it turned without injury.

Chucks are, in general, of two kinds, recessed and spindle, Fig. 325. In the recessed chuck a depression is

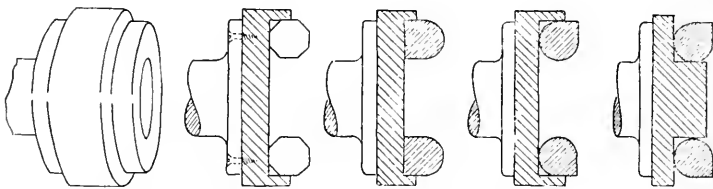

FIG. 325. TURNING A RING—FIRST METHOD.

made slightly deeper than half the thickness of the project to be held. The project must fit against the bottom of the depression and snugly enough at the sides so that it shall not move when the scraping tool is applied. In the spindle chuck the spindle is turned to such a diameter that the internal opening of the project may fit quite snugly and not permit the project to move on the chuck while turning. In either case the project is to be held in place by what is known in the machine shop

as a "press fit," a fit made in this case by firm pressure of the hand.

The exact details of preparing the stock for chucking will be found to vary with different turners. For example,

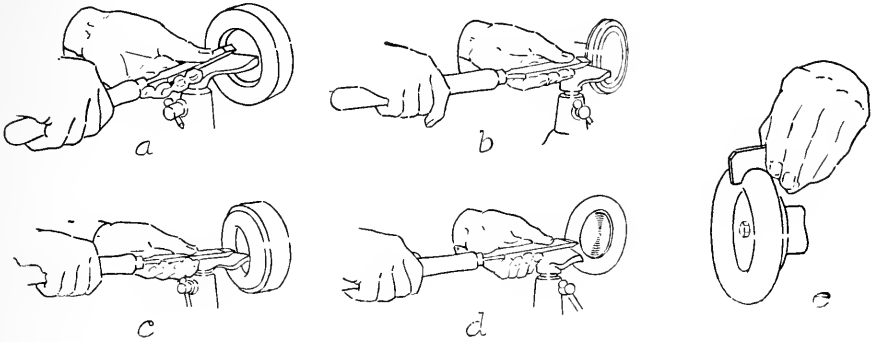

FIG. 326. TURNING A RING—SECOND METHOD.

consider the turning of a ring. Fig. 325 shows steps which may be taken. Fig. 326, a, b, c, d, shows another way. Fig. 327 illustrates a third way. Any one of these methods would be considered good practice. In all three ways will be seen certain essentials. After the ring has been turned to a square section the next essential step is in making out of this square section an octagonal one, a process made use of in joinery, forging, etc., where a square is to be formed into a circular section.

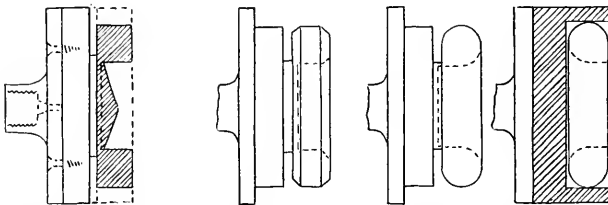

FIG. 327. TURNING A RING—THIRD METHOD.

In the method illustrated in Fig. 325 a face-plate is made use of which is sufficiently small to allow the outer edge of the ring to be modeled before its insertion in a

chuck. The stock at the center is removed no more than is necessary to allow the outer edge to be rounded over. This center is removed just before chucking. In modeling the outer edge a templet should be made use of as in Fig. 326.

In Fig. 326 the ring is chucked as soon as the square section is completed on the face-plate. The templet to be used here in connection with the chuck work would be but one-fourth of a circle.

In Fig. 327 the ring is three-fourths completed in contour before being chucked. This is made possible thru using a much thicker piece of stock than is used in either of the other methods, the ring being separated from the remainder of the stock by means of the parting tool as shown. This extra thickness of stock would prove a serious drawback to this method were the wood being turned expensive.

In turning such projects as napkin rings, a chuck will be used to hold the stock when boring out the center. A mandrel may be used to hold the ring after it is bored.

- (1) Place the stock between centers and turn it to the approximate external diameter at its largest point.
- (2) Chuck one end and bore the other to a depth slightly over half way. Boring is merely end scraping, the tool rest being placed at right angles to the line of centers and the tool held parallel to the line of centers.
- (3) Remove, and chuck the second end and complete the boring. This boring should be carefully done so that the project may fit the mandrel neatly.
- (4) Prepare a mandrel by turning a piece of stock between centers until it has a diameter suitable for the placing of the ring, one that will hold the ring in place during the turning of its convex or external surface.
- (5) Place the ring upon the mandrel and complete the turning, Fig. 328.

Another example of chucking is to be seen in the process of turning a sphere. (1) The sphere is turned between centers, being made as nearly spherical as possible, Fig. 329. A templet may be made and used to test. (2) The stock is removed from the lathe centers and the dead and live ends cut off. (3) A chuck like that shown in Fig. 330 may be prepared. As in other chucks the project must be held snugly at its circumference and have its inner surface resting against the bottom of the depression of the chuck.

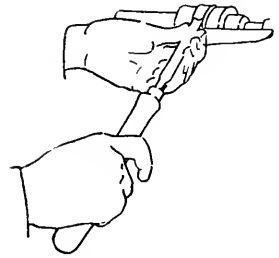

FIG. 328.
MANDREL WORK.

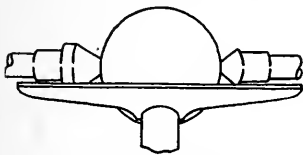

FIG. 329.
TURNING SPHERE
BETWEEN CENTERS.

Fig. 331 shows a chuck in which the ball is recessed only about one-fourth of its diameter, instead of being recessed slightly over one-half as in the case of the first chuck shown. The sphere is held in place here by drawing up the tail stock and placing a piece of leather between the cup center and the project. This leather will revolve and prevent any

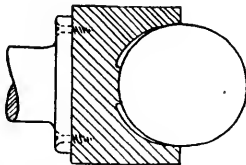

FIG. 330.
CHUCKING A SPHERE
—FIRST METHOD.

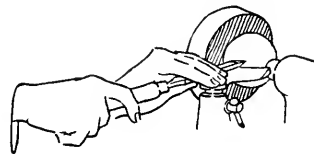

FIG. 331.
CHUCKING A SPHERE—
SECOND METHOD.

injury to the surface of the sphere. (4) The essential thing in the case of either kind of chuck is the movement of the sphere in the chuck made at various stages of the turning process. This movement consists in turning the

sphere slightly, never more than thru an arc of 45° , taking off a shallow scraping, then shifting again in the same direction. As the ball grows smaller thru successive scrapings the chuck will need to be made deeper to hold it. (5) Since the turning between centers made the ball or sphere circular in section across the grain, it must be placed in the chuck first so that it may be rounded up in the opposite direction. The secret of success lies in the frequent shifting of the sphere in the chuck, after each slight scraping, with thought or method as to the direction this shifting is made to take.

190. Sandpapering and Finishing.—If the work has been well done, the tools properly sharpened and properly used, very little sandpapering will ever need to be done. If edged tools or scraping burrs are not producing smooth surfaces they should be attended to at once so that what sandpapering is needed may be done with paper of fine grit. Paper left from joinery sanding, worn paper, is better than fresh paper for this work. If new paper is used, it must be moved back and forth slowly that scratches may not be produced on the surface of the work. Do not make use of high speed in sanding for fear of burning or scorching the wood.

If the wood to be finished is coarse grained, such as oak, it should be filled with a paste filler in the usual manner of applying paste fillers. After the filler has flatted, the piece may be placed in the lathe, run on low speed, and the filler rubbed into the open grain and off the highlights, a soft pad being used. Finish the rubbing with a cloth. A second coat may be applied in the same manner after a wait of twenty-four hours. Sometimes a third coat is required in order to bring the smoothness desired. On close grained wood such filling is not necessary.

For a waxed finish, apply a coating of wax to the project, by means of the fingers or a cloth. Allow this to stand five or ten minutes; then start the lathe at low speed and polish by holding a soft cloth against the revolving stock. Another coat may be applied in the same manner after a wait of an hour.

A shellac finish, somewhat similar to that known as French polish, is obtained as follows: (1) Turn the lathe with the hand and apply a coat of shellac to the



FIG. 332. SHELLACKING AND POLISHING.

project. (2) Allow it to set for five or ten minutes, or until the shellac is dry enough to sandpaper. (3) Sand lightly with worn or No. 00 paper. (4) Moisten a piece of soft cotton cloth with a little thin shellac. (5) Hold this against the revolving project with a light but firm and uniform pressure, moving the pad slowly to and fro across the project, Fig. 332. A drop or two of linseed or machine oil placed on the pad will assist in causing the shellac to flow properly. An excess of oil, however, will destroy the possibility of a permanent gloss. (6) Should the shellac have a tendency to "pile up" it may be removed by increasing the pressure at that point, the pressure causing the shellac to heat and flow.

Some patience will be required to master this finish. Once the amount of pressure and the movement is learned, a fine surface may be produced such as cannot be produced in any other way.

Where a close-grained wood is used the natural color of the wood may be greatly enhanced by the application of a coat of boiled linseed oil or of paraffin oil as a first coat. Allow this oil to stand over night after the excess has been rubbed off with a clean cotton cloth.

CHAPTER VI.

INLAYING AND WOOD-CARVING.

191. Inlaying: General Considerations.—The process of inlaying consists of setting pieces of one material into closely fitting recesses in a solid ground of another and contrasting material. Inlay is most effective as a means of decoration on woods of fine grain such as walnut, mahogany, gum, maple, etc. For the inlay, a wood of fine grain with little tendency to split is necessary. In all cases the inlay should be prepared before the recesses, as it is much simpler to fit the recess to the inlay than the reverse.

192. Directions for Forming and Fitting Inlays of Irregular Outline.—Designs such as shown in Fig. 333 are best executed in $\frac{1}{16}$ " white holly veneer as follows: (1) The required design should be carefully traced on rice paper or architects' tracing paper. (2) The individual forms should be transferred, one by one, to the veneer with carbon paper. (3) With saw and chisel cut the pieces from the sheet of veneer and trim to exact size and shape with a sharp pocket knife. Straight edges may be planed if the size of the piece permits. Straight ends may be cut with a chisel. Pieces so small as to be difficult to hold are best worked by forming as completely as possible at the end of a larger piece before cutting off. Small, sharp curves are cut with the point of the knife, or, if absolutely necessary, with a jewelers' file. The

file should be used only as a last resort. Careful attention must be given the direction of the grain to avoid splitting delicate pieces. The edges must be straight from top to bottom, and should be slightly beveled to insure

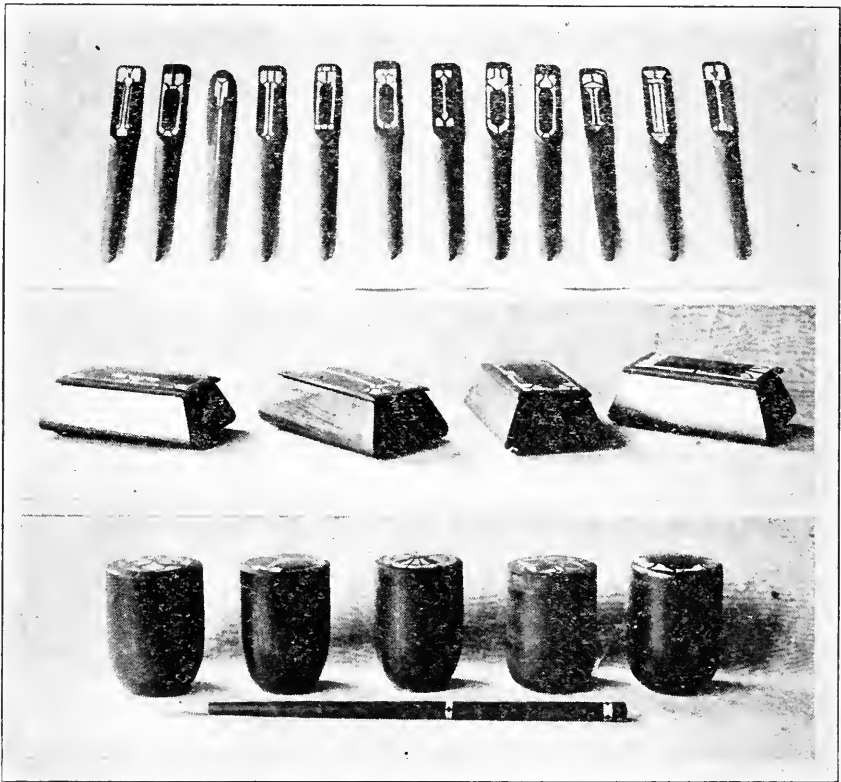

FIG. 333. INLAYS OF IRREGULAR OUTLINE.

a close fit. (4) When all the required pieces have been prepared it is wise to set them out in their proper relative positions to see that they fit properly with one another, making any necessary corrections.

In laying out recesses it is best to work from center lines wherever possible. (5) Hold the first piece to be inlaid in position on the project and carefully trace

around it with a sharp, hard pencil. Great care must be taken that the piece does not slip while its outline is being traced. Do not attempt to trace the outline directly from the drawing. (6) With the point of a sharp knife cut around this outline slightly inside the line, Fig. 334.

(7) Remove the material between these cuts to a depth slightly less than the thickness of the veneer being used. This may be done with the carving tools or with the knife. Narrow spaces are best sunk by means of the knife, cutting in from

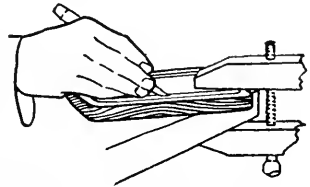

FIG. 334. OUTLINING.

the sides. Wider spaces may be scored across the grain with the knife point. The bottoms of these recesses need not be smooth; in fact, a slight roughness is an advantage in that it forms a good key for the glue. The sides, however, must be sharp and clean cut.

(8) Place the inlay in position and fit by enlarging the recess until the piece can be forced into place by the pressure of the vise or clamps. (9) When properly fitted, remove the inlay with the point of a knife; glue the recess thoroly, and force the inlay into place. (10) Proceed in like manner with the other pieces. It is not necessary to wait for the glue to set before going ahead with the other pieces. It is best to glue each piece in place as soon as its recess is prepared, as this lessens the liability of splitting out the small spaces between the pieces. On irregular surfaces a block may be used to force the inlay into position, or it may be rubbed into place with the face of a hammer.

(11) After the glue has thoroly set, cut down the inlay flush with the surface of the ground with a plane, if possible, or with a flat gouge. Should this be done before the glue has had time to set, the inlay is apt to be

drawn below the surface of the ground by the contraction due to drying. (12) The entire surface is now sand-papered, using a block that the inlay and ground may be kept flush.

193. **Strings and Bandings.**—Strings, such as shown in Fig. 335, are best formed by ripping strips from the edge of a sheet of veneer whose thickness is equal to the width of the required line. Double strings and bandings, such as those shown in Fig. 336, are built up somewhat



FIG. 335.
BANDINGS APPLIED.

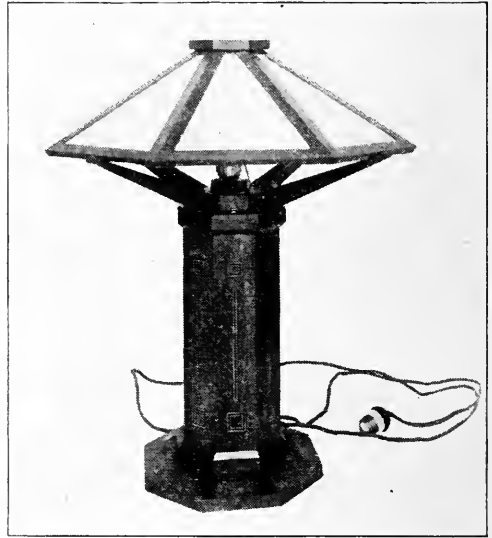

FIG. 336.
DOUBLE STRINGS AND BANDINGS.

as indicated in Fig. 337. Bandings are carried in stock in the larger cities in endless varieties of combinations and woods. They are sold by the yard in varying widths but with a uniform thickness of about $\frac{1}{16}$ " , and at prices so low, because of the economy of quantity production, that few, even of the large commercial users of bandings, trouble to make up their own inlays.

194. Directions for Building up a Typical Banding.—

For those schools where, for educational reasons, it is desired that the boys shall build their own bandings the following directions are given: Suppose it is desired to build up a banding such as that shown at C in Fig. 337.

(1) Having determined the length of banding required and the relative proportions of the veneers to be used, glue and clamp between blocks the alternate layers of walnut and holly as shown in A,

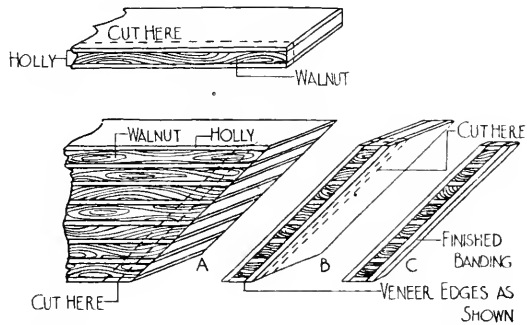

FIG. 337. STEPS IN BUILDING A BANDING.

Fig. 337. (2) After the glue on this has had time to set, place the stock on a circular saw and cut off the diagonal slabs or layers as indicated by the dotted lines of A, Fig. 337. (3) Sand these surfaces lightly, remove the dust, then glue to either side the holly veneer as shown at B, Fig. 337. (4) After the glue has hardened on these slabs, it remains to cut off thin layers on the circular saw of about $\frac{1}{16}$ " as indicated by the dotted lines of B, Fig. 337. These layers are ready for insertion in the recesses made in the ground material.

The ingenuity which may be exercised in the arrangement of woods and colors in building up line inlays is limitless.

195. Directions for Laying Strings and Bandings.—

Strings and bandings may be laid either with gage and knife, or with the scratch stock.

First Method: Lines with the grain are laid with the gage, the spur of which must be filed to a knife edge, as

shown in Fig. 338. The vertical edge of the spur must be toward the outside of the line. Either two gages, one

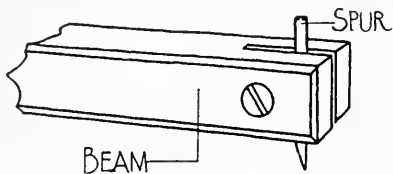

FIG. 338.
GAGE FOR INLAY WORK.

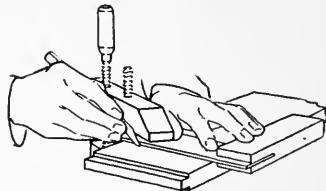

FIG. 339.
CUTTING ACROSS THE
GRAIN.

for each side of the recess, or a mortise gage should be used. After scoring the lines to the necessary depth with the gages, the material between the lines is to be split out or routed with knife or chisel.

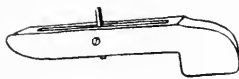

FIG. 340.
SCRATCH STOCK.

Lines across the grain are cut with the knife held against the edge of a square which is firmly clamped in position as in Fig. 339.

Curves are cut with the knife freehand, or guided by a templet, or with the gage, or with the compass, as the case permits.

Second Method: The recesses may be cut with a scratch stock, shown in Fig. 340, using a cutter equal in width to that of the required recess. This tool may be made from a block of maple, or from a marking gage. Plow bits make excellent cutters. Fig. 341 illustrates the manner of using this tool.

Care must be taken to keep the head firmly pressed

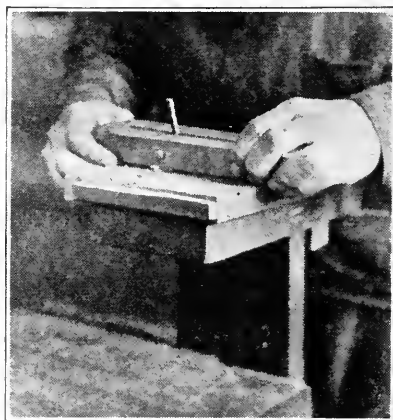

FIG. 341. SCRATCH IN USE.

against the edge of the ground material and to take light cuts. The cutters must be kept sharp.

When laying bandings around curves the longitudinal joints should be split, in order that the sections may slip along each other when bent. They should, of course, be reglued when set in place.

Bandings for sharp curves should be built up in a mold, Fig. 342. The thin veneers used bend quite easily, particularly if thoroly heated before gluing. For the wider lines use two or more thicknesses of thin veneer. Only a good grade of hot glue should be used for this work.

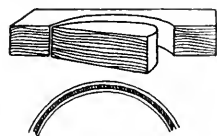

FIG. 342.
BUILT-UP BAND-
INGS FOR CURVED
WORK.

Color in inlay is usually obtained by the use of different woods. Thin veneer may be colored thru by soaking in some of the penetrating stains now on the market.

196. Directions for Marquetry.—A good illustration of marquetry, or the laying of irregular forms within irregular forms, is that shown in Fig. 343. The top of this jewel casket is made up of three pieces of $\frac{1}{16}$ " veneer, with the butterfly design mortised or recessed into the top veneer.

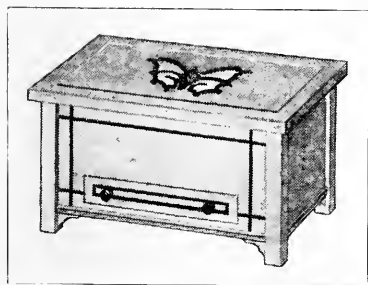

FIG. 343. JEWEL CASKET.

The butterfly design mortised or recessed into the top veneer. The three part veneer is necessary, for when the top veneer is laid, there must be a veneer of corresponding thickness laid to the underside of the core to counteract the effect of the veneer attached to the top surface. The paneled effect of the top is obtained by means of a border of veneer raised $\frac{1}{16}$ " above the ground. A good combination of woods would be mahogany for the ground and maple for the wings with rosewood borders and body.

(1) Fasten together three veneers of the woods just mentioned, $\frac{1}{16}$ " each in thickness, by means of a touch of glue at the corners. (2) Attach a blueprint of the butterfly to the top veneer using a touch of glue at each corner. (3) When the glue has set, using a fine-bladed coping saw, cut out the innermost outline. Next saw the more remote outline. Since all three pieces of veneer are sawed alike, the maple may be used for the centers of the wings, and the rosewood for the borders, and the mahogany for the ground. Where fine enough blade is not at hand a slightly thicker blade may be made to serve by placing the rosewood on the mahogany and the maple on the rosewood and inclining the blade so that the aperture of the mahogany will be approximately of the same size as that of the piece which is to fit into it when all are cut. (4) Shade the maple as required by dipping the pieces into hot sea-sand placed in a tray over a strong flame. A pair of tweezers will permit the pieces to be handled without discomfort, so that the scorching may be applied as desired. The wood should not be held in the sand long at a time or it will be burned instead of merely scorched. (5) Make the feelers by sharpening $\frac{1}{16}$ " black veneer and driving this into the kerfs made by the coping saw at appropriate places in the ground, the sawing being done before the ground veneer is placed. (6) Place the ground and the various pieces of butterfly veneer upon a piece of paper, with what is to become the top side of the veneers next to the paper. Use a touch of glue on each to hold the same in place. (7) Apply plenty of glue to the exposed surfaces of the core and clamp all three parts between two thick plane blocks. This pressure will force the glue into the saw kerfs so that the joints are hardly visible in the finished piece. (8) When the glue is

hardened thoroly remove the clamps and smooth the surfaces.

197. Finishing.—The inlay may be harmonized in tone with the ground by giving the entire project a coat of hot linseed oil. If the full contrast is desired the inlay should be given a coat of white shellac before the finish is applied. French polish and rubbed varnish are advised as finishes for inlaid work.

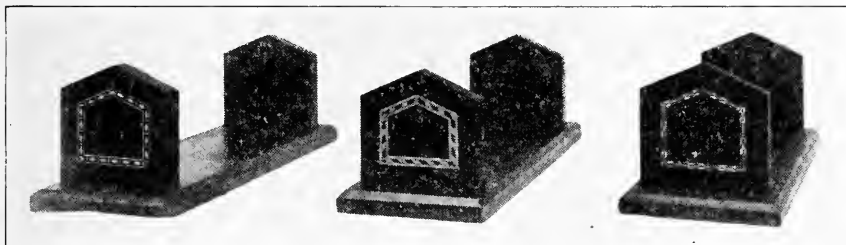

FIG. 344. APPROPRIATE APPLICATION OF INLAY.

Fig. 344 illustrates an appropriate application of inlay.

198. Wood-Carving.—The hard woods, such as oak, walnut, mahogany, gum, etc., offer fewer difficulties to the wood-carver than do the softer woods. The latter tend to tear under the pressure of the tool unless it is perfectly sharpened.

Carving tools must never be allowed to become dull, but must be kept sharp at all times. When properly sharpened a carving tool will cut across the grain of a piece of soft wood without tearing, and will leave a smooth and shining surface.

199. General Directions.—The required design if it consists of straight lines, may be drawn upon the wood with a straight-edge or with the tee-square and triangle, but if made up largely of curved lines, it should be traced freehand on the work by means of carbon paper, and corrected if necessary with pencil. The drawing and

carbon paper may be held in place with pins or thumb-tacks if care is taken to stick them in the background spaces.

The work to be carved must be firmly held. The vise may be used, or the piece may be clamped to the bench top, or to a carving stand, as shown in the illustrations which follow. These stands serve to raise the work above the level of the bench top and make the work much easier.

The tools should be laid out on the bench top with the cutting edges toward the carver, that he may select the required tool without loss of time.

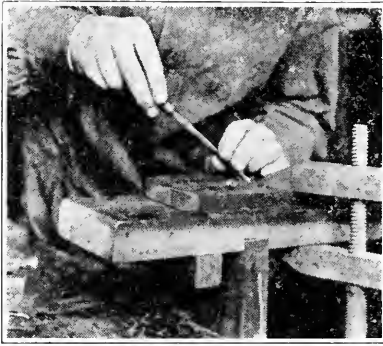

FIG. 345.

POSITION FOR LIGHT WORK.

For light work the tool is held as shown in Fig. 345. The end of the handle is held in the palm of the right hand and the blade is grasped by the thumb and first two fingers of the left hand. For heavier work the blade

should be grasped in the palm of the left hand as shown in Fig. 346. In either case the right hand pushes forward against the resisting pressure of the left, which must rest on or against the work or the bench. The pressure of the right hand should be just enough greater than the resistance of the left to force the tool slowly and firmly thru the wood. In no other way can the proper control of the tool be obtained. In making vertical cuts the handle is often held in the right hand as shown in Fig. 347. The cutting edge is guided by the left hand, and the weight of the body is used in forcing the tool into the work.

The use of the mallet is unnecessary save in large and deep work. In light work better results will be obtained by striking the tool with the heel of the palm of the hand as shown in Fig. 348.

200. Line Carving.—Simple line designs, such as those of Fig. 349, are best executed with a "veining" tool, that is, a $\frac{1}{16}$ " No. 2 gouge, held as in Fig. 345. Care must be taken to keep the angle between the tool and the surface of the work constant, for upon this angle depend both the width and the depth of the cut. Do not work over the lines a second time if it can be avoided.

The line being followed should come in the middle of the shaving raised by the tool. Start all lines a little inside the corners, finishing toward the corners in all cases. In cutting curves the tool must be so held that at all times its center-line lies in a plane tangent to the curve at the cutting edge of the tool. Strive for straightness of direction and smoothness of curve, rather than at mere geometric accuracy.

Sometimes good effects are produced by staining and finishing the surface of the wood before the lines are carved, and then refinishing the entire carved surface without the use of stain. This gives greater prominence to the lines of the design, but any inaccuracy in the cut-



FIG. 346.
POSITION FOR HEAVY WORK.

ting is made more apparent. This method, therefore, should not be attempted until the worker has acquired some skill.



FIG. 347.
VERTICAL CUTTING.

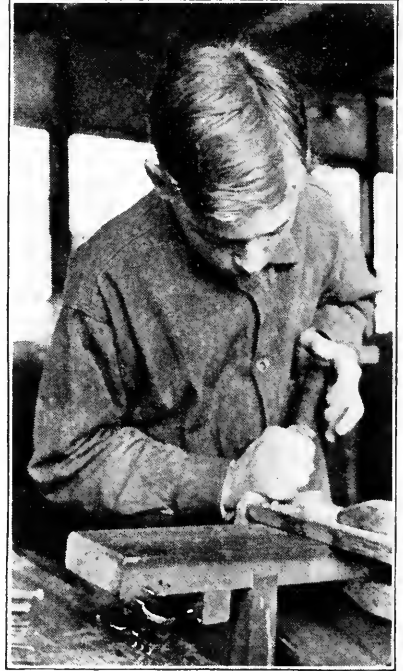

FIG. 348. USING THE HAND
FOR POUNDING.



FIG. 349. LINE DESIGNS.

201. **Ribbon Carving.**—Another simple and effective form of wood-carving consists of bands or ribbons produced by cutting a triangular groove on either side of a band as shown in Figs. 350 and 351. In cutting these grooves make the first cut a vertical one, and make it a short distance outside of the line of the band. This is to prevent crushing the wood on the edge of the band. In detail, the steps in the cutting process are: First, make a vertical cut about $\frac{1}{16}$ " outside of the line of the band; second, from outside of this cut make a cut sloping toward the first cut at the desired angle, thus releasing a chip; third,

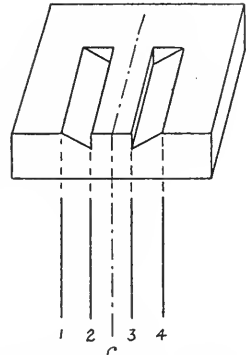

FIG. 350. SECTIONAL VIEW OF RIBBON CARVING.

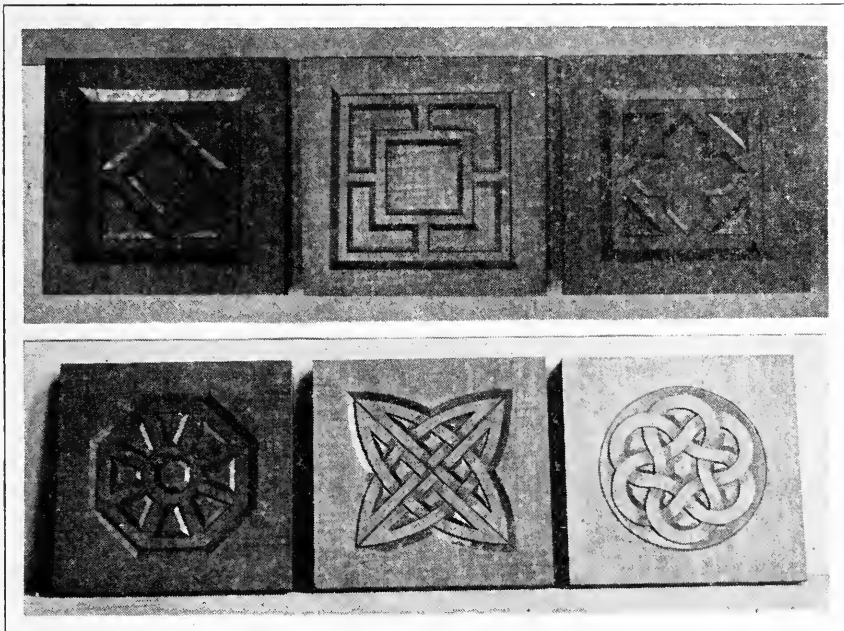

FIG. 351. RIBBON CARVING.

cut down vertically on the line of the band; repeat the last two steps till the required depth is reached.

In laying out a design there are two methods of procedure. In the first a center line, as in Fig. 350, is the

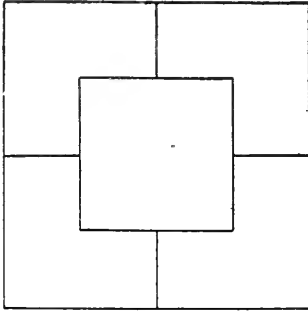

FIG. 352.

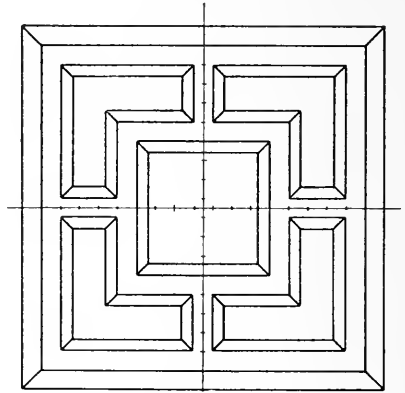

FIG. 353.

CENTER LINE METHOD OF LAYING OUT RIBBON CARVING.

base of measurement. If it is desired to use the design, Fig. 352, for ribbon carving, all the lines of the design are regarded as center lines, and on each side of every line will be drawn two other lines corresponding to lines 1, 2, 3 and 4 in Fig. 350. When all these lines have been drawn, and the corner connections made, the result will be as shown in Fig. 353. In laying out the lines of bands in a design of this character it is often convenient to divide the entire space of the design into small squares. In Fig. 353 the center lines of the large square are divided to indicate how the space might be divided into little squares equal in dimensions to the width of the band. In this case the design is nineteen units square. It will be noticed that the outer groove around the design is made a full unit in width, whereas the other grooves are somewhat narrower—in this case three-fifths of a unit. The reason for making the outer groove wider is

to unify and strengthen the appearance of the design. This widening of the outer band may be noticed in all the designs in Fig. 351.

The second method of procedure in laying out designs for ribbon carving is to start with the entire space across the band and the two bevels, or across the four lines in

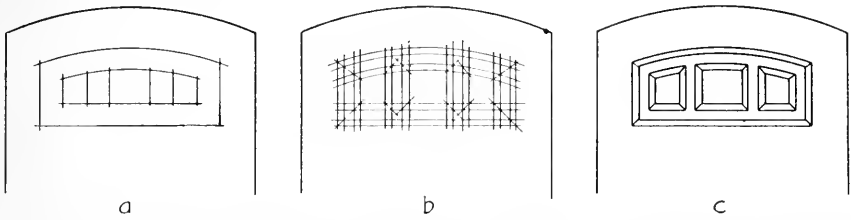

FIG. 354. SPACE DIVISION METHOD OF LAYING OUT RIBBON CARVING.

Fig. 350. This method is usually better when adapting a design to given proportions and shape of outline. For example, in a, Fig. 354, a broad band, which is to include the final band and two grooves, is drawn parallel to the upper edge of the object to be decorated and at the desired distance from it. Then this broad band is broken up as indicated in b and c, Fig. 354. The distance of the design from the top and sides of the object, and the width of the band and the grooves should be studied to give the most pleasing effect when the object is completed.

202. Grounding Out and Molding.—Another type of wood-carving is suggested by the Flemish carved oak tracery of the fifteenth and sixteenth centuries, examples of which are shown in Figs. 355 and 356. This consists of grounding out, or cutting down, to make a background, and then molding the edges.

The background spaces or "ground" are sunk as follows: (1) With a narrow gouge of quick sweep, say $\frac{1}{4}$ ", No. 9, cut around the spaces keeping a little inside the lines. (2) With the same tool held on its side, remove

the surplus material by a series of parallel cuts directly across the grain. Repeat this operation, if necessary, until the depth of the ground is but little less than that

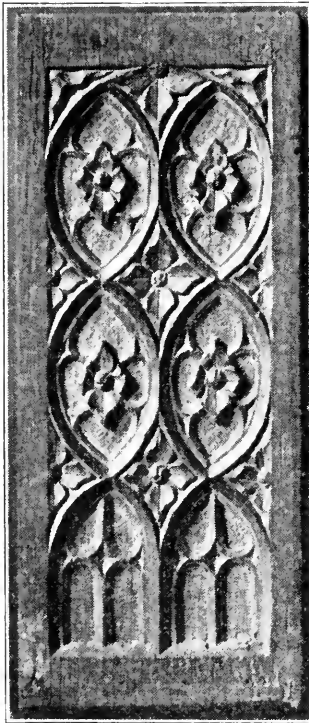

FIG. 355.



FIG. 356.

EXAMPLES OF FLEMISH CARVING IN THE BOSTON MUSEUM OF FINE ARTS.

required in the finished carving. (3) The sides of the grounds should next be cut down square, the tool being held as in Fig. 347. The depth of these "firming" cuts should be slightly greater than the required depth of the background, straight lines are firming with gouges that fit them best. In case no gouge is at hand to fit a particular curve, it may be firming either with a skew chisel, held as in Fig. 357, and swung about the left hand as a fulcrum, or with a gouge ground to a convex edge and rocked over (along) the required curve. (4) The

background is next sunk to the required depth and smoothed with gouges of slow sweep, say Nos. 3 and 4, sometimes called "flat gouges." The smoothing cuts

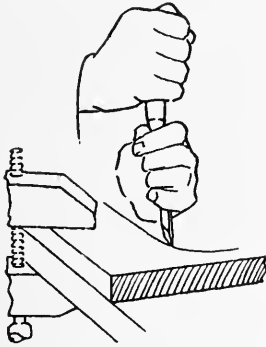

FIG. 357.
FIRMED WITH A SKEW
CHISEL.

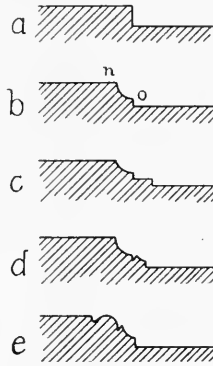
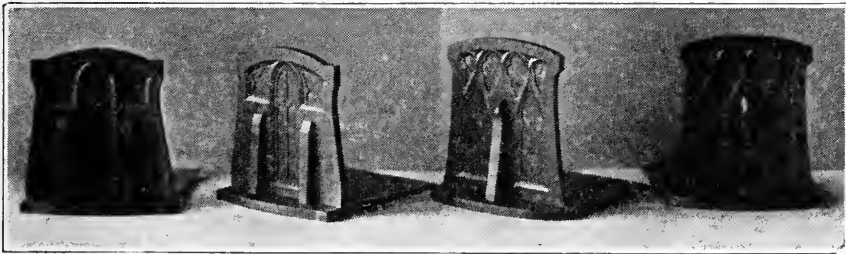

FIG. 358.
CROSS-SECTIONS OF
MOULDINGS USED
IN CARVING
TRACERY.

must meet the firming cuts so that the chips may be freely removed without any prying action with the tool. Do not use chisels for the smoothing.

After the process just described, the edges of the



a b c d
FIG. 359. BOOK SUPPORTS CARVED WITH TRACERY DESIGNS.

grounds are as shown in a, Fig. 358. The next step is to cut the corners off as indicated in b, Fig. 358, thus producing the curved moulding. This is done with a

gouge of medium size and the curvature needed to make the required molding. The result will appear as in c

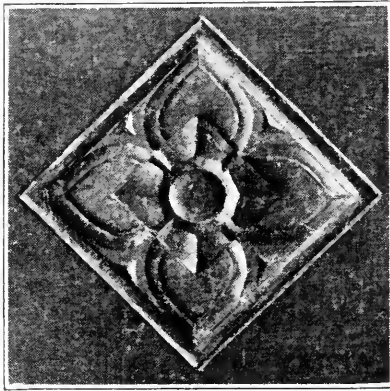

FIG. 360. SIMPLE MODELING.

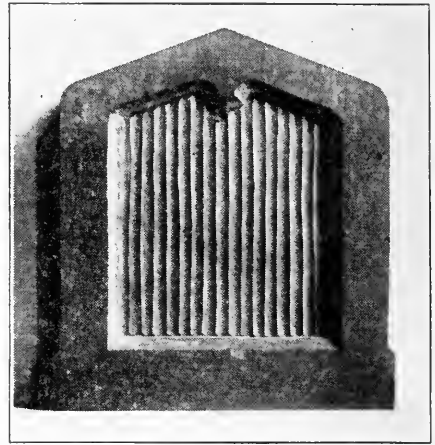
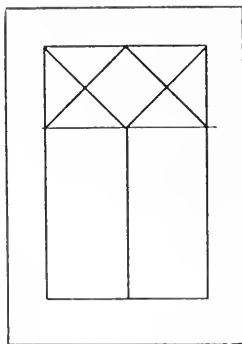

FIG. 361.

A TREATMENT OF BACKGROUND.

and d, Fig. 359. A very simple means of adding more complexity and interest to the design is the form of molding shown in c, Fig. 358 and applied in a and b, Fig. 359. The molding shown in d, Fig. 358, is the one



a

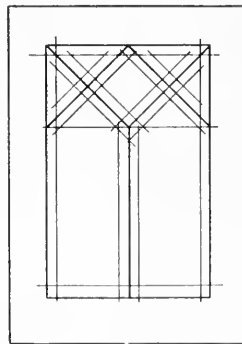

b

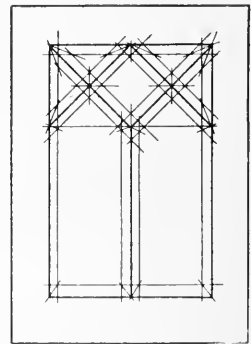

c

FIG. 362. THREE STEPS IN LAYING OUT A TRACERY DESIGN.

employed in Fig. 355; the one shown in e, Fig. 358, is found in a slightly modified form at the bottom of Fig.

356 and in Fig. 360. In the center of this latter design some very simple modeling is introduced. Suggestions for similar modeling may be found in Fig. 355. A treatment of background which sometimes proves very effective is shown in Fig. 361. Fig. 362 indicates the three steps in laying out a design of this type. All the lines in a, except the light horizontal line, indicate the upper corner of the molding as n in b, Fig. 358. In b, Fig. 362, lines corresponding to o, Fig. 358, have been added. C, Fig. 362, shows the addition of the intersection lines of the moldings. In Fig. 362 all the lines are straight, but the steps in the process are the same when the lines are curved as in Fig. 363. The decorative cusps,

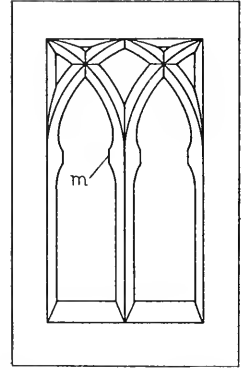

FIG. 363. A SIMPLE TREATMENT OF CUSPS.

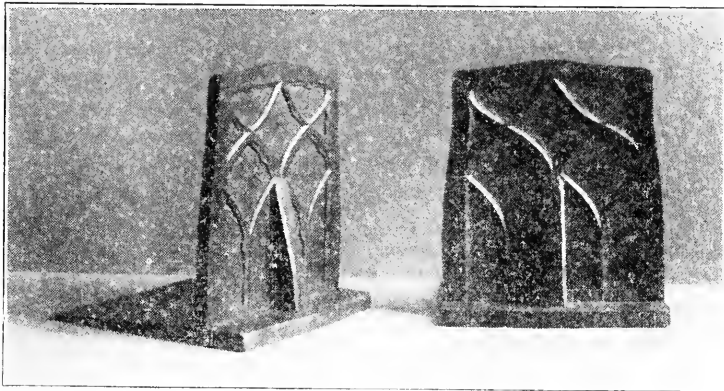

FIG. 364. FREE USE OF CUSPS IN TRACERY DESIGN.

m, in Fig. 363, need not cause any departure from the simple following of the fundamental lines cutting the molding. This fact is made evident by Fig. 364.

203. **Modeling.**—In relief carving, Figs. 365, 366, 367, the foreground masses stand out from the background

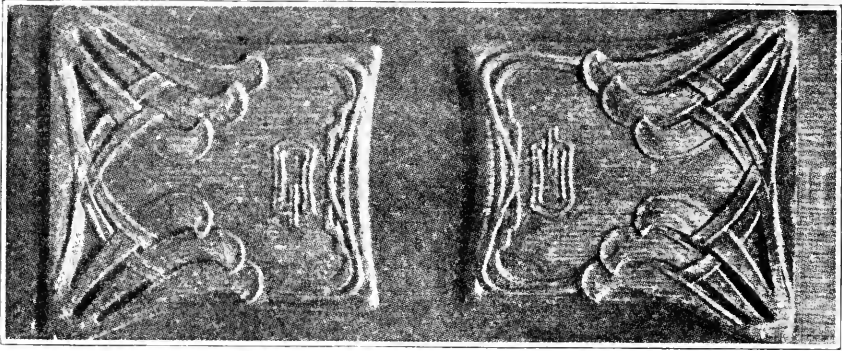

FIG. 365.

FOLDING BOOK-RACK WITH INTERLACED AND MODELED DESIGN.

spaces, and are usually modeled, according to the character of the design.

When the design permits, an interesting texture may be given the foreground masses, and a pleasing play of light and shade thrown across the carving by modeling, Fig. 368.

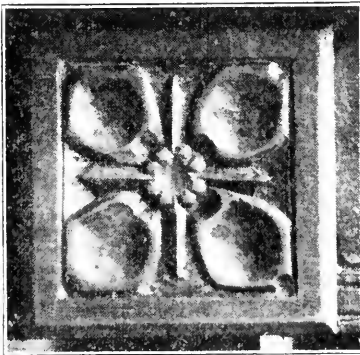

FIG. 366.

SIMPLE MODELED ROSETTE.

The texture of carving is due to the minute tool marks left on the surfaces. These marks should help express the rhythm of the design and explain the form. The use of scrapers or sandpaper destroys these marks and is therefore to be avoided. The degree of smoothness required depends upon the scale of the carving and the position it is to occupy. Large work to be viewed from

a distance requires a bolder, rougher treatment than small work to be seen close at hand. A general rule for small work is to make all surfaces as smooth as possible by the cutting action of the tools. Perfection of form rather than smoothness of surface distinguishes good carving.

204. Light and Shade.—The sparkle of carving is due to the uneven reflection of light by the varying surfaces. Those surfaces that reflect the light directly give the high lights; those that reflect it obliquely give the half-tones; the sharp edges give dark shadows on the background. These lights and shades should be balanced over the carving to correspond roughly with the distribution of interest in the spotting of the design. Variety of surface gives variety of light and shade. The background in Fig. 368



FIG. 367. ROSETTE
WITH FLORAL PANEL.

is a good example of surface treatment. Winding or twisting surfaces are particularly effective.

The modeling cuts should be made with as few changes of tools on each surface as possible, using tools whose curvatures correspond with those of the surfaces required. The large number of facets produced by the use of too many different tools on a surface tend to make the carving look labored, and lose the sharpness and crispness so essential to interesting texture.

Many rounded forms may be cut by holding the gouge

with the convex side up. Very delicate modeling may be done with the tool held as in Fig. 369. By twisting the U-shaped tools, while taking a cut, a very great change in curvature may be effected on a surface without the necessity of changing tools.

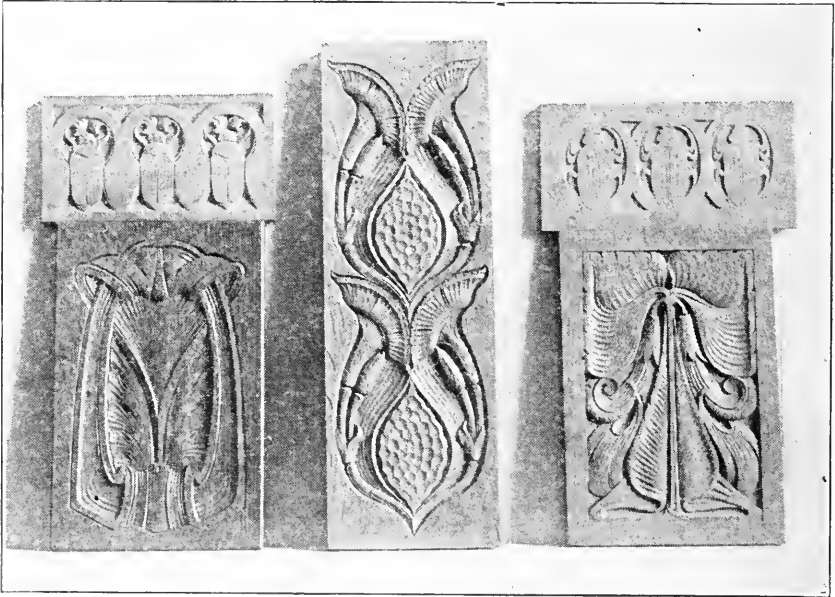

FIG. 368. EXAMPLES OF SURFACE TREATMENT FROM A SCHOOL IN LEIPSIK, GERMANY.

The modeling must be decided. Let the rounded surfaces be distinctly rounded, and the high points distinctly high, etc. Avoid uncertainty either of form or contour. Without a certain clear-cut sharpness, carving loses its distinctive character as a tool-wrought ornament.

It is often wise to try a design on a piece of scrap material to determine the scheme of modeling best adapted to it before attempting its final execution. Modeling the form in clay is still better, because it is so easily changed.

205. Finishing Carvings.—Carvings may be finished with oil, wax, or filler, followed by a thoro brushing to remove the surplus finishing material. The dull finish produced by these methods is much preferable to a high gloss. A finish of the latter sort tends to emphasize the tool marks and renders the carving harsh and hard. Varnish and polish should not, as a general thing, be used on carving.

206. Pierced Ornamentation.—Pierced ornamentation, such as that shown in Fig. 370, may be used to "lighten up" the appearance of an otherwise heavy-looking design. Such ornamentation, like inlay and carving, must not be allowed to interfere with the strength or utility of the project, and the spaces and lines must be as carefully thought out with reference to the project as a whole. Like inlay and carving, ornamentation such as this must not be used to excess.



FIG. 369. METHOD OF HOLDING TOOL FOR VERY DELICATE MODELING.

High-school boys may well have access to a jig-saw for work such as this. (1) A hole will be bored in the waste, the saw blade inserted and the kerf kept quite close to the line. (2) A chisel or gouge should be used for completing the work, as far as possible. A fine wood file may be used, care being taken to keep the edges square and straight. File marks should be removed with a scraper.

Where a jig-saw is not available a compass saw will serve as a substitute.

Straight line designs may be laid off directly upon the wood. Curved line designs should be traced from a full size drawing by means of carbon paper and a stylus. In either case it is wise to prepare full size drawings first, that the proper proportioning of parts may be secured without damage to the wood thru changed markings.



FIG. 370.
PIERCED ORNAMENTATION.

CHAPTER VII.

WOOD FINISHING.

207. **Wood Finishes.**—Finishes are applied to wood surfaces (1) that the wood may be preserved, (2) that the appearance may be enhanced.

Finishing materials may be classed under one or the other of the following: Filler, stain, wax, varnish, oil, paint. These materials may be used singly upon a piece of wood or they may be combined in various ways to produce results desired.

208. **Brushes.**—Good brushes are made of bristles of

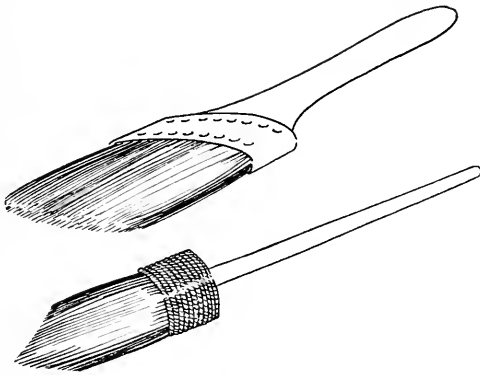

FIG. 371. BRUSHES BOUND IN METAL AND WRAPPED WITH WIRE.

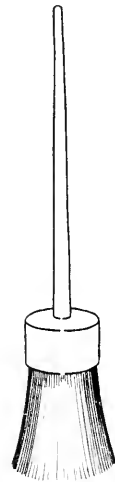

FIG. 372. DUSTING BRUSH.

the wild boar of Russia and China. These bristles are set in cement and are firmly bound by being wrapped with wire in round brushes or enclosed in metal in flat brushes, Fig. 371.

A large brush, called a duster, is used for removing dust or loose dirt from the wood, Fig. 372. Small

brushes, used for tracing, usually have chisel edges, Fig. 373.



FIG. 373. SMALL
CHISEL EDGE BRUSH.

Bristle brushes are expensive and should be well cared for. Brushes that have been used in shellac and are not soon to be used again should be cleaned by rinsing them thoroly in a cup of alcohol. This alcohol may be used later for thinning shellac.

Varnish and paint brushes should be cleaned in turpentine. If they are to be laid away for some time, a strong soap-suds, or lather, made from some of the soap powders, should be well worked into the brush, after the preliminary cleansing. It should then be carefully pressed into proper shape and laid away flat on a shelf. When the brush is to be used again, it should first be washed out, to get rid of all the soap.

Brushes that are used from day to day should be kept suspended, when not in use, as in Fig. 374, so that their bristles shall be kept moist, without their touching the bottom of the bucket or can.

Since alcohol evaporates rapidly, shellac cans with cone tops should be used.

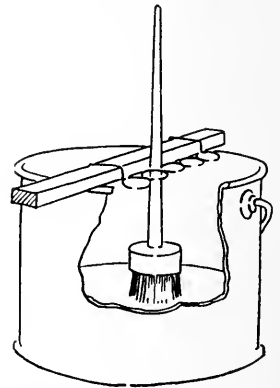

FIG. 374. METHOD OF
SUSPENDING BRUSHES.

Fig. 375 shows a can which is made double. Varnish is kept in the inner portion and water in the outer ring. The cover fits over the inner can and into the water space, thus sealing the varnish airtight but removing all danger of the cover's sticking to the sides of the can. The brush is suspended from the "cleaning wire" so that its bristles rest in the liquid.

If delicate woods are to be varnished, stone or glass jars would better be used to hold the liquid, as metal discolors it slightly.

209. **General Directions for Using Brush.**—(1) Hold

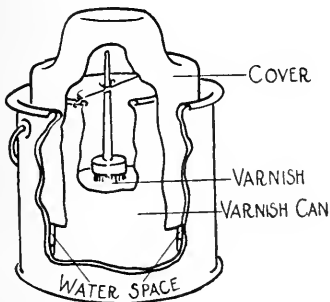

FIG. 375. DOUBLE CAN—
PREVENTS EVAPORATION.



FIG. 376. CORRECT
METHOD OF HOLDING
BRUSH.

the brush as in Fig. 376. (2) Dip the end of the brush in the liquid to about one-third the length of the bristles. (3) Wipe off the surplus liquid on the edge of the can, wiping both sides of the brush no more than is necessary to keep the liquid from dripping. A wire stretched across the can as in Fig. 377 provides a better wiping place for the dripping brush. In wiping the brush on the edge of the can, some of the liquid is likely to "run" down the outside. (4) Using the end of the brush, apply the liquid near one end of the surface to be covered. (5) "Brush" in the direction of the grain. (6) Work towards and out over the end of the board, leveling the liquid to a smooth film of uniform thinness. The strokes should be "feathered," that is, the brush should be lowered gradually at the beginning of the sweep and raised gradually at the close, otherwise, ugly "laps" will result. The reason for working out over

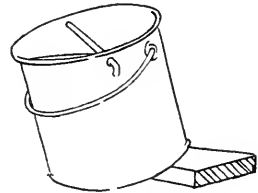

FIG. 377. WIRE
DEVICE FOR WIPING
BRUSH.

the ends rather than from them will appear with a little thought. (7) Now work toward the second end. The arrows, Fig. 378, show the general directions of the final or feathering strokes of the brush.

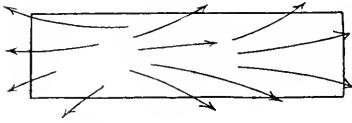

FIG. 378. FINAL OR FEATHERING STROKES.

Edges are usually covered first and adjoining surfaces afterward.

It frequently happens that surplus liquid runs over a finished surface, especially when working near the arrises. This surplus can be "picked up" by wiping the brush upon the wire of the bucket until the bristles are quite free of liquid, and giving the part affected a feathering sweep.

If the object has an internal corner, work from that out over the neighboring surfaces.

Panels and sunk places should be covered first. Afterward, the raised places, such as stiles, rails, etc., may be attended to. Wherever possible the work should be laid flat so that the liquid may be flowed on horizontally. This is of special advantage in varnishing. Vertical work should always be begun at the top and carried downward.

Tracing consists in working a liquid up to a given line but not over it, such as painting the sash of a window. Tracing requires a steady hand and some practice. A small brush is generally used and the stroke is made as nearly continuous as the flow of the liquid will allow, Fig. 379.

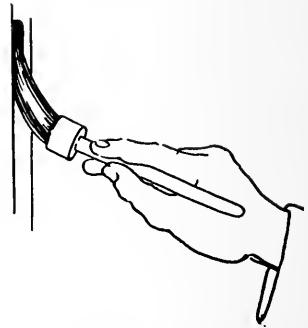

FIG. 379. TRACING TO A GIVEN LINE.

210. Fillers.—Fillers are of two kinds, paste and liquid. They are used to fill up the wood pores and thus give

a smooth, level, non-absorbent surface, upon which other coverings may be placed. Paste fillers are for use upon coarse-grained woods such as oak and chestnut, while liquid fillers are for close-grained woods such as Georgia pine.

Fillers are not a necessity, especially the liquid kind, but the saving effected by their use is considerable. Not only are they cheaper than varnish but one or two coats of filler will take its place and permit a saving of two or three coats of the more expensive material.

Liquid filler should be applied evenly with a brush and allowed to dry twenty-four hours, after which it may be sanded smooth with No. 00 paper. It is used mainly upon large work such as porch ceilings and interior finish, like Georgia pine. On fine cabinet work, one or two coats of thin white shellac is used as a filler upon close-grained wood. Shellac forms a surface which, after twenty-four hours, can be sandpapered so as to make a very smooth surface. Varnish applied to the bare wood has a tendency to darken and discolor it. Filling with shellac preserves the natural color.

Paste filler is sold by the pound in cans of various sizes. The best fillers are made of ground rock crystal mixed with raw linseed oil, Japan and turpentine.

For preserving the natural color of the wood, filler is left white; for Flemish, it is colored brown; for antique and weathered finishes, it is dark. Fillers can be purchased ready colored.

211. Filling with Paste Filler.—(1) Thin the filler with turpentine until it makes a thin paste. (2) With a stiff-bristled brush, force the filler into the pores of the wood and leave the surface covered with a thin coating. (3) Allow this to stand until the filler has “flatted,” that is, until the “gloss” has disappeared and the filler

becomes dull and chalkish. The time required for this to take place varies. Twenty minutes is not unusual. (4) Rub the filler off just as soon as it has flatted—do not let it stand longer, for the longer it stands the harder it is to remove. Rub across the grain as much as is possible, using a wad of excelsior. Finish fine work by going over it a second time with a cloth, rubbing with the grain as well as across, that the "high lights" may be clear of filler.

On fine work use a felt pad to rub the filler into the pores, and rub off with a cloth only.

Twenty-four hours should be allowed the filler to harden. One filling is sufficient for ordinary work; on fine work the above process is sometimes repeated after the first filling has hardened.

The striking contrasts in the grain of wood such as oak and chestnut, obtained by the use of colored fillers, are due to the dark filler's remaining in the open grain but being wiped off of the close grain—the "high lights."

On quarter-sawed oak, each flake is sometimes sanded with fine paper, No. 00, to remove the stain that the contrast may be sharper.

Excelsior and rags used in cleaning off filler must not be allowed to lie around, but must be burned, as they are subject to spontaneous combustion and are dangerous.

212. Stains.—Stains are used to darken the high lights of wood preparatory to the application of a relatively darker filler. By varying the intensity of the stain different results may be obtained with the same color of filler. Stains are also used without fillers.

There are three kinds of stains: (1) water, (2) oil, (3) spirit. Each kind has its advantages and its disadvantages.

Water stains are cheap, penetrate the wood deeply, and are transparent. They cause the grain of the wood to "rough up," however, and for this reason are used mainly upon hard woods which require darkening before the application of a filler. The wood is sanded before the filler is applied. Where water stain is not to be followed by filler, it is customary to thoroly moisten the surface to be covered with water alone. After this has dried, the surface is sanded with fine paper and the stain applied. The stain does not raise the grain as it otherwise would.

Water stains may be applied with a brush or a sponge. They are sometimes heated that they may enter the wood more deeply. Any coloring matter that can be dissolved in water will make a wood dye or stain.

Oil stains, like water stains, are often used to stain wood before filling. They are more generally used where no filling is desired. They are easier to apply evenly than water or spirit stains. They do not raise the grain of the wood like the other stains. On the other hand, they do not penetrate and therefore cannot color hard woods dark. Neither do they give the clear effects.

Most oil stains are applied with a brush, after which the surface of the wood is immediately wiped clean with a cloth.

Spirit stains are but little used where surfaces of any size are to be covered. They are expensive, fade easily, and are hard to apply evenly.

They are applied with a brush and dry very quickly.

A stain which penetrates deeply and is clear is obtained by placing the wood in a closed receptacle in which is placed a dish of concentrated ammonia. The fumes of this liquid cause a chemical change to take place, giving to the wood a rich nut-brown color.

213. **Waxing.**—An old finish that has recently become popular is that of waxing. It takes the place of the varnish, by which it was supplanted years ago.

Wax finish is easily applied and is cheaper than varnish. It will not stand wetting. However, it is easily repaired.

Our ancestors used to make wax polish by “cutting” beeswax with turpentine.

Rapid drying and hardening waxes can be purchased now-a-days. They require a smooth surface and a very thin application for a successful result. Too much wax upon a rough surface will produce very ugly, white, chalk-like spottings as the wax dries. These are especially noticeable upon dark finishes. Waxes colored black overcome this but are not needed if the ordinary wax is properly applied.

In finishing with wax the following directions may be followed: (1) Stain the wood if a very dark finish is desired. (2) If the wood is coarse-grained, put on two coats of paste filler and rub it off carefully, that a smooth surface may be prepared. Allow the stain twelve hours in which to dry, also each coat of the filler. (3) With a soft cloth apply as thin a coating of wax as can be and yet cover the wood. Wax is in paste form. (4) Allow this to stand five or ten minutes, then rub briskly with a soft dry cloth to polish. (5) After this coat has stood for one hour another may be applied in the same manner.

A thin coat of shellac brushed evenly upon the hardened filler “brings out” the grain and makes an excellent base for wax as well as varnish. It should stand twenty-four hours and then be sanded smooth with No. 00 sandpaper before the wax is applied.

There are other patent preparations which give the same soft effects as wax and are as easily applied—in fact, some of them are but wax in liquid form.

214. Varnishes.—Varnishes are used where a hard transparent coating is desired. There are two kinds, (1) shellac or spirit varnish, (2) copal or oil varnish.

Varnishes vary greatly in quality and therefore in price. If made of specially selected pale gum for use on light or white woods the price will be higher than for that of ordinary color tho the quality may be no higher.

Rubbing varnishes are so made that they may take a “rubbed finish.”

Varnishing should be done in a room in which the temperature can be kept from 70° to 80° Fahr., and which is comparatively free from dust. The surface to be covered must be clean, dry and filled even and smooth.

215. Shellac.—Shellac or spirit varnish is a solution of lac and alcohol. Lac is soluble in both grain and wood alcohol but grain alcohol is preferable. Beds of crude lac are found in parts of Africa and South America where the lac has been left by the decay of leaves and twigs which it at one time encrusted. Crude lac is deposited upon leaves and twigs of certain of the lac-bearing trees by countless numbers of insects which draw out the sap.

Stick-lac is crude lac which has been purified somewhat of the bodies and eggs of the insects and rolled into stick forms. When crushed and washed it is known as seed-lac. When fully purified, which is done by melting and straining, it is spread out and is known as shellac.

White shellac is obtained by bleaching. Orange shellac is unbleached. Pure white shellac is used where the more yellow shellac would discolor. Orange shellac is stronger than white and will last longer, but is harder to apply because it sets more rapidly.

Shellac varnish sets quickly, dries hard but softens under moisture. Unlike oil varnish, it does not "level up" and must, therefore, be brushed on quickly, using long, even strokes. No spots must be omitted for they cannot be "touched up."

216. Shellac Finishes.—The use of one or more coats of shellac preparatory to a varnish finish has been noted.

A very simple finish, and one that is easily applied, is obtained by covering stained wood with a very thin coat of shellac.

To obtain the finish known as egg-shell gloss, (1) Coat the smooth wood with from three to six applications of thin shellac. Allow each coat twenty-four hours in which to harden. (2) Rub to a smooth surface each hardened coat, using curled hair or fine steel wool or fine oiled sand-paper.

217. Oil or Copal Varnishes.—Oil varnish is composed of copal gum, boiled oil and turpentine. Copal gums are obtained from Africa mainly, in certain parts of which they are found as fossil resins, the remains of forests which once covered the ground.

Pressed flaxseed furnishes crude linseed oil, while the long leaf pine of the South furnishes the turpentine pitch.

The oil is prepared for use by boiling it in huge kettles with different materials which cause it to change chemically. It is then put away to settle and age, that is to clear and purify itself. It takes from one to six months for the oil to reach a proper degree of clearness and purity. Turpentine is obtained from its pitch by distillation.

The copal gums are melted and boiled thoroly with the oil. Turpentine is added after the mixture of gum and oil has cooled sufficiently. The whole is then strained several times, placed in tanks to age or ripen. From one month to a year, or even more, is required.

The quality of varnish depends upon the qualities of the gums, the proportion of oil and turpentine and the care which is exercised in the boiling process.

218. Flowing Copal Varnish.—(1) Lay on the varnish quickly in a good heavy coat. Use a good varnish brush and dip the bristles deeply into the liquid, wiping them off just enough to prevent dripping. (2) Wipe the bristles quite free of varnish; go over the surface and pick up as much of the surplus liquid as the brush will hold. Replace the varnish in the can by wiping the bristles on the wire of the can. Repeat until the entire surface has been left with but a thin smooth coating.

Two, three, four or more coats are applied in this manner, forty-eight hours being allowed between each for drying. Dry varnish comes off in sanding as a white powder; if not dry it will come off on the sandpaper as little black spots.

219. Typical Finishes for Coarse-Grained Woods.—**Egg-Shell Gloss:** (1) One coat of water-stain, English golden, etc., according to the result desired. (2) Allow time to dry, then sandpaper lightly with fine sandpaper. This is to smooth the grain and to bring up the high lights by removing stain from some of the wood. Use No. 00 sandpaper and hold it on the finger tips. (3) Apply a second coat of the stain diluted about one-half with water. This will throw the grain into still higher relief and thus produce a still greater contrast. Apply this coat of stain very sparingly, using a rag. Should this stain raise the grain, again rub lightly with fine worn sandpaper, just enough to smooth. (4) When this has dried, put on a light coat of thin shellac. Shellac precedes filling that it may prevent the high lights—the solid parts of wood—from being discolored by the stain in the filler, thus causing a muddy effect. The shellac being

thin does not interfere with the filler's entering the pores of the open grain. (5) Sand lightly with fine sandpaper. (6) Fill with paste filler colored to match the stain. (7) Cover this with a coat of orange shellac. This coat of shellac might be omitted but another coat of varnish must be added. (8) Sandpaper lightly. (9) Apply two or three coats of varnish. (10) Rub the first coats with haircloth or curled hair and the last with pulverized pumice stone and crude oil or raw linseed oil.

Dull Finish: A dead surface is obtained by rubbing the varnish, after it has become bone dry, with powdered pumice stone and water, using a piece of rubbing felt. Rub until the surface is smooth and even, being careful not to cut thru by rubbing too long at any one spot. The edges are most likely to be endangered. Use a wet sponge and chamois skin to clean off the pumice.

Polished Finish: The last coat should be rubbed first with pulverized pumice stone and water, and then with rotten stone and water. For a piano finish rub further with a mixture of oil and a little pulverized rotten stone, using a soft felt or flannel. A rotary motion is generally used and the mixture is often rubbed with the bare hand.

Gloss Finish: For a gloss finish, the last coat is not rubbed at all.

220. **Patching.**—It frequently happens in rubbing with pumice that the varnish is cut thru so that the bare wood shows. To patch such a spot proceed as follows: (1) Sandpaper the bare place lightly with very fine paper, No. 00, to smooth the grain of the wood raised by the pumice water. (2) If the wood has been stained or filled, color the spot to match the rest of the finish. Apply a little with a cloth and wipe off clean. (3) When this has dried, carefully apply a thin coat of varnish to the bare

wood. Draw it out beyond the bare wood a little, "feathering" it so that there shall not be a ridge. (4) Allow this to dry hard and apply a second coat, feathering it beyond the surface covered by the first coat. (5) Repeat until the required thickness has been obtained. (6) Rub with pumice and water. Rub lightly, using a little pumice and much water. The slightly raised rings made by the lapping of one coat upon another will need special attention. It is best not to sandpaper between coats, because of the danger of scratching the rubbed finish adjoining the patch.

221. Painting.—The purpose of paints is to preserve the wood by covering it with an opaque material. Paints are usually composed of white lead or zinc oxide and coloring materials mixed or thinned with raw or boiled linseed oil. Turpentine is also used for thinning and as a drying agent.

Paint must be well brushed out so that a thin film may result.

In painting, (1) cover the knots with shellac, or the oil of the paint will be absorbed thru two or three coats and a discoloration result. (2) Put on a prime coat. This coat should be mixed as thin as it can be and still not "run" when applied to vertical surfaces. (3) Fill the nail holes with putty. Sand lightly if a smooth finish is desired. (4) Apply two or three coats of paint thin enough to flow freely but thick enough to cover well and not "run."

The second coat is given a little more than the usual amount of turpentine that a "flat effect" may prepare the way for the final gloss coat. If the last coat is to be dull, turpentine is used in it as well as the second. Oil causes gloss, turpentine causes a dull or flat effect.

222. Wood Finishing Recipes.—Wax: Cut up beeswax and add to it about one-third of its volume of turpentine. Heat to the boiling point in a double boiler. Or, melt a quantity of beeswax and to this add an equal quantity of turpentine. Care must be taken that the turpentine shall not catch fire.

Water Stains: Any coloring matter that is soluble in water will make a stain.

Mahogany: Three quarts of boiling water, one ounce of Bismarck-brown aniline.

Brown: Extract of logwood, the size of a walnut, dissolved by boiling in four ounces of water. Apply hot and repeat until the desired color is obtained.

Black: First stain the wood brown with the logwood solution. Coat this with a stain prepared as follows: Soak a teaspoonful of cast iron filings in four ounces of acetic acid or vinegar. Allow it to stand for a week, stirring it occasionally.

Walnut: Make a strong solution of powdered bichromate of potash and hot water. Over this stain, apply a coat of the logwood stain.

Oil Stains: Coach colors ground in Japan when thinned with turpentine make good stain. Mix in the proportion of one-half gallon of turpentine to one pound of color and add a little boiled oil. Colors commonly used are drop-black, Vandyke brown, medium chrome yellow, burnt and raw umber and burnt and raw sienna.

Green: Drop-black, two parts; medium chrome yellow, one part; a little red to kill the brightness.

Walnut: Asphaltum with a little Venetian red.

Golden oak: Asphaltum and turpentine thinned like water, to be followed with filler darkened with burnt umber and black.

Antique oak: Raw sienna properly thinned, with a little burnt umber and black added.

Spirit Stains:

Black: Alcohol and aniline black.

Mahogany: Alcohol and Bismark brown.

Aniline stains cut with alcohol, and mixed with white shellac and banana oil or amyl alcohol in equal parts, make good stains for small pieces of work.

Colored Fillers:

Antique oak: Natural filler darkened by the addition of burnt Turkey umber.

Golden oak: Natural filler darkened by Vandyke brown and black asphaltum varnish.

Flemish oak: Natural filler darkened by Vandyke brown, burnt Turkey umber, and drop black.

Forest green: Natural filler colored with lampblack and chrome yellow.

CHAPTER VIII.

FURNITURE CONSTRUCTION.

223. **General Discussion.**—In getting out stock, whether by hand or machine, the worker should learn to so arrange his operations that both time and material may be used with economy. To save time, see that a complete stock bill is made out before beginning to get out any material. Arrange this bill so that pieces of like lengths, widths or thicknesses may be determined readily. Posts for table legs, etc., where the ends must be worked carefully, should be cut at least $\frac{1}{2}$ " longer than is required in the completed piece. Widths usually require $\frac{1}{4}$ " extra and thicknesses $\frac{1}{8}$ ". In cutting rails to length, which are to have tenons on the ends to fit into blind mortises, time and material will be saved if the rails are cut neat length, that is, the length between the shoulders plus the lengths of the tenons.

In the selection of the faces, it should be remembered that face marks are not used to indicate the best surfaces necessarily, but rather the two surfaces first worked and from which other surfaces are to be worked. Also, that face surfaces or sides being more likely to be accurate than the other surfaces worked and tested from them, are to be turned in so that members may join face to face or end to face as far as possible. This will necessitate care in selecting the stock and the faces. Arrange so that sap streaks, small knots and other imperfections shall be concealed when the parts are assembled, as far as is practicable.

In squaring small posts by hand the student should learn to test for straightness by sighting along the length with one eye. For wind he may test by sighting over two squares, Fig. 380. Sight over the top edges to see if the arrises line up. If the piece is long, move one of the squares along the member from place to place until a sufficient number of places have determined the general surface. As a rule, square all members to width and thickness before beginning to lay out joints. In laying out joints observe the instructions given in Chapter IV.

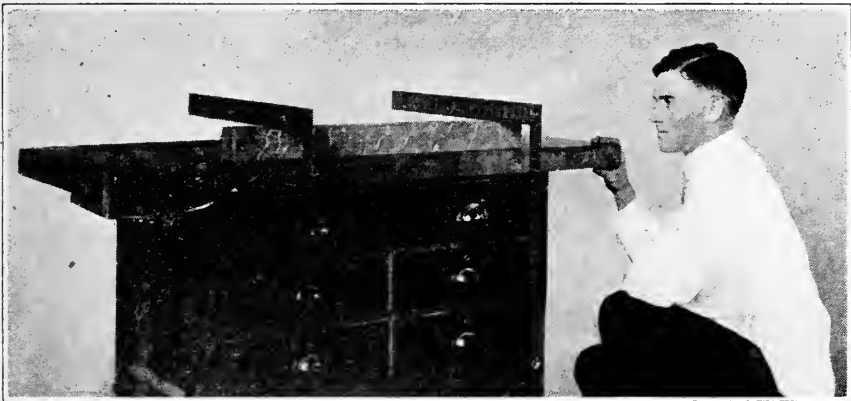

FIG. 380. TESTING FOR WIND.

224. **Designing.**—Designing is nothing more than combining familiar elements in new ways. The quickest way for a shop student to develop judgment in such matters is to plentifully provide himself with plates of working drawings of furniture of various types. Such plates should provide the elements in the form of information about fastenings of parts, proportions of members, etc. It remains for the student to make the new combinations. The teacher of furniture design should be ready to point out lack of proper interpretation of any given form or proportion on the part of the pupil.

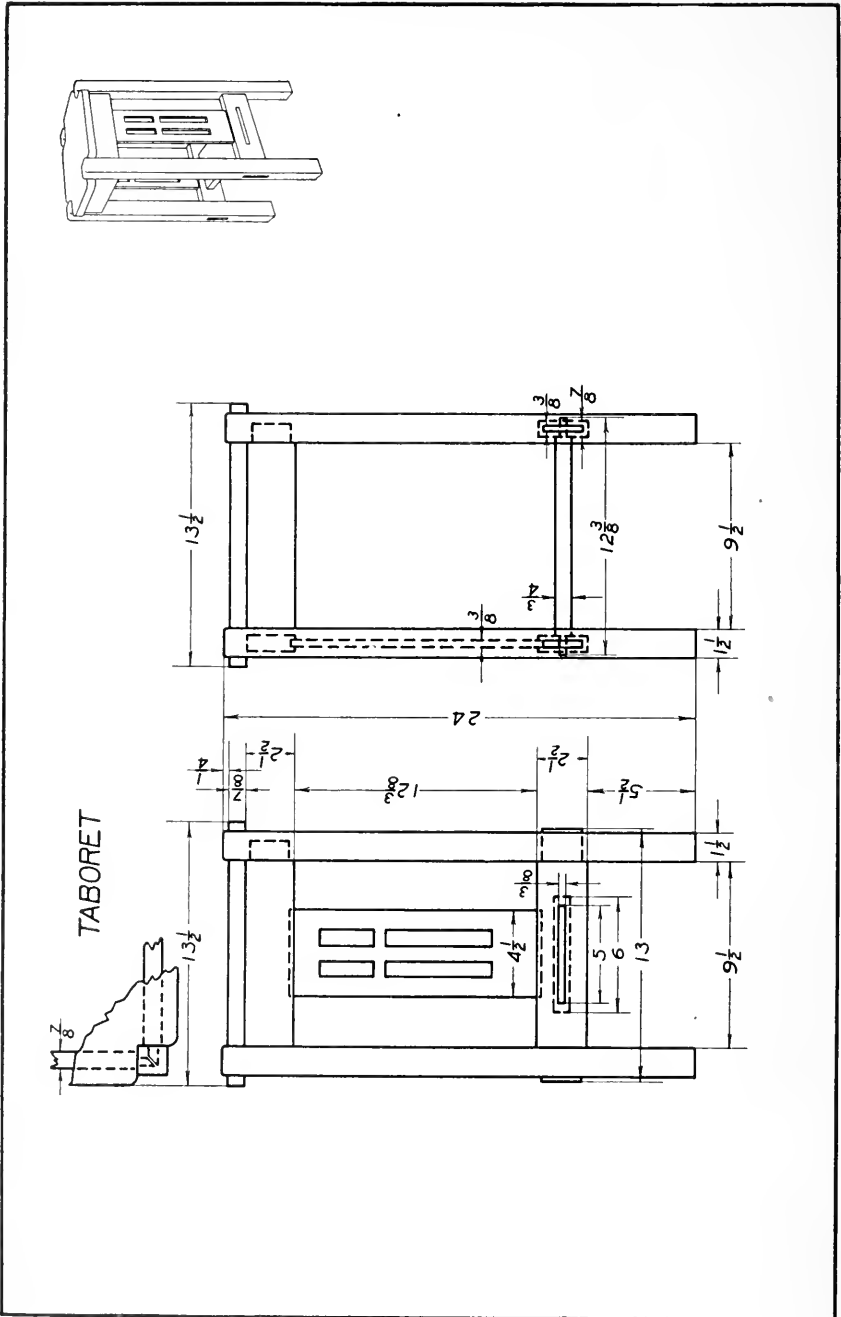

FIG. 381. TYPE DESIGN FOR TABORET.

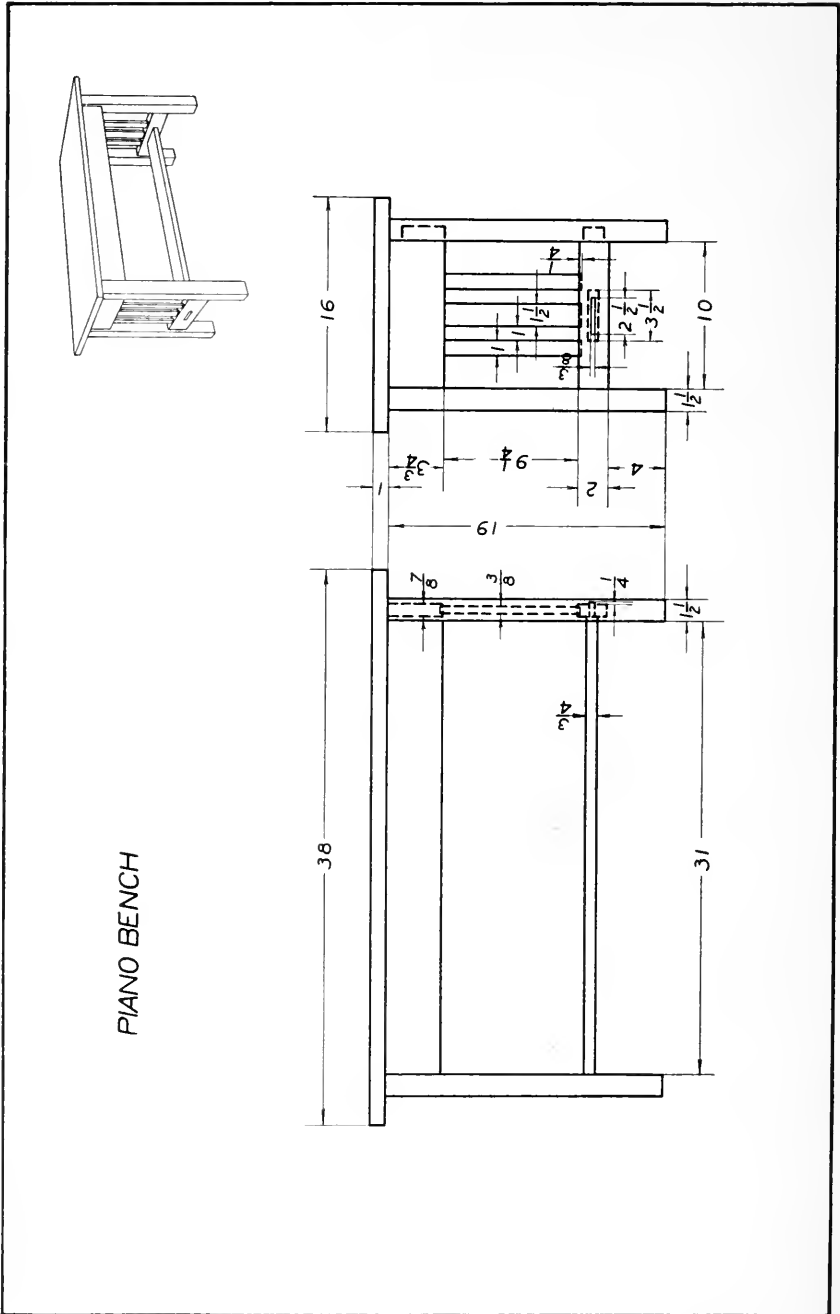

FIG. 383. THRU TENON NOT NECESSARY.

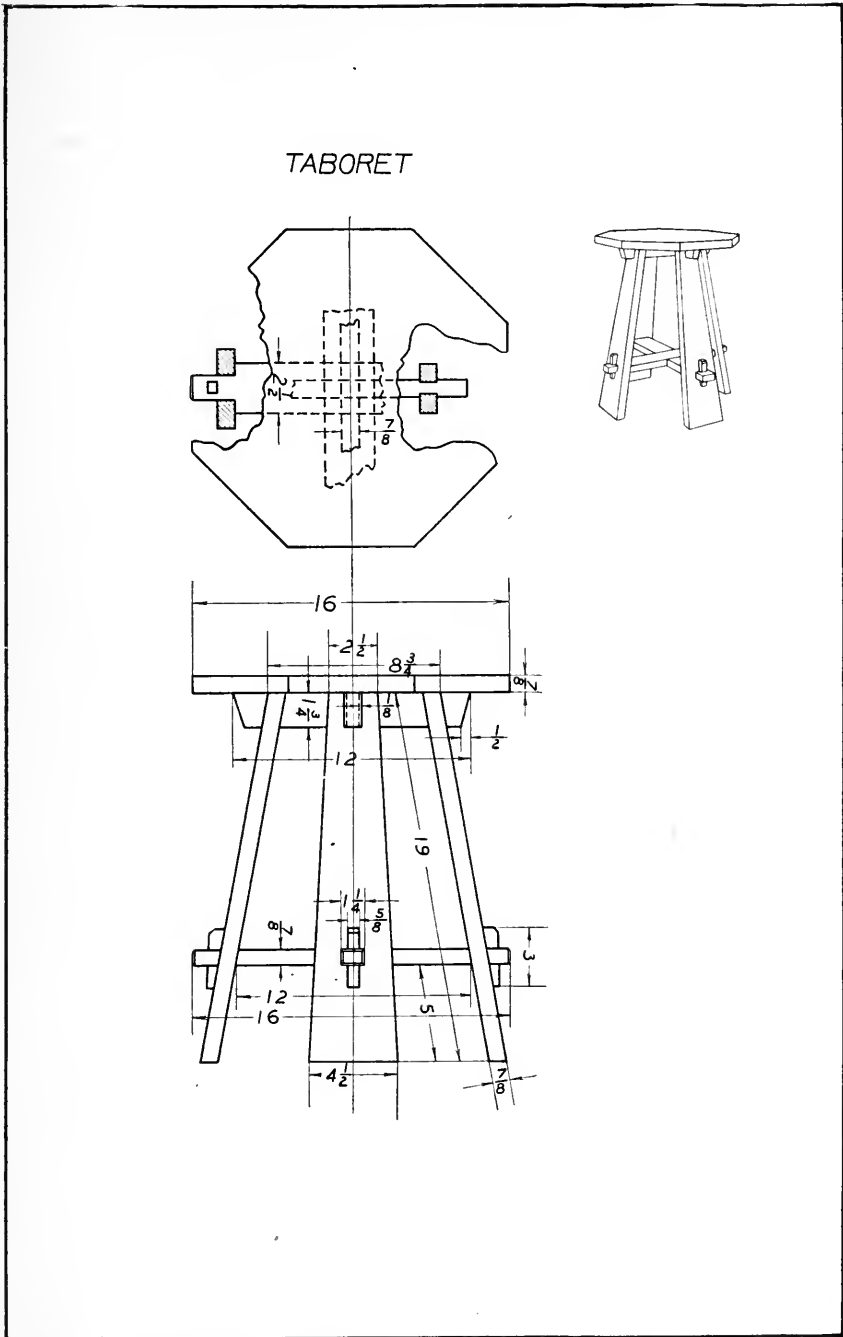

FIG. 384. POSSIBILITIES OF KEYED TENON.

To illustrate, suppose the student wishes to design a taboret. In looking over plates of furniture design he finds the taboret drawing, Fig. 381, the general style of which is in harmony with other fittings in his home. Looking still farther he finds the drawing of a chair, Fig. 382, which offers suggestions for modifying the panel construction of the taboret just mentioned. In the piano bench, Fig. 383, he sees that the thru tenon on the lower rails of the taboret is not a necessity. He also notes the approximate sizes of the joints and gets ideas of possible proportions of parts. In Fig. 384 the possibilities of the keyed tenon are brought to his attention when applied to the stretcher. The final result may be like Fig. 385.

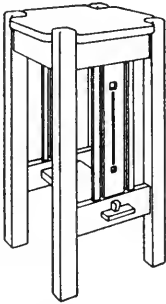

FIG. 385.

ULTIMATE DESIGN.

It is true that the result here is quite consciously thought out. The process, however, is just as true to type, so far as the creative process is concerned, as is the case when an expert designs a piece of furniture. The only difference lies in the fact that the expert is so familiar with the elements out of which he builds his design that he has left only the "meaning" or "feeling." He seems to design or create new forms without ever having considered any work other than his own. Let the student strive to acquire this same state of mind or feeling, remembering that it is the result of patient study and application rather than of supernatural power granted only to the few, and that possible new combinations are almost limitless in number.

225. Structural Details.—In determining the size and character of tenons and mortises, mechanics do not make use of definite formulas. On the other hand, it would be

a mistake to conclude that no thought is given to the matter. Theoretically, a tenon and mortise should be so designed that they may be so strong mutually, that neither one could be made stronger without a consequent weakening of the other. In actual practice mechanics do not strive for this theoretical nicety, but rather elect to use certain standard sizes, determined in no small part by the tool equipment.

For illustration, a tenon or mortise worked on stock $\frac{3}{4}$ " in thickness would, in all probability, be made $\frac{3}{8}$ " in width or thickness. A rail 2" in width, shouldered on four sides, would probably have a tenon $1\frac{1}{4}$ " in width. Nor is it absolutely essential that tenons shall be exactly centered if, by offsetting slightly, gage settings may be made more readily. It is very essential, of course, that gagings shall be made on both members from the faces, and the faces planned so that joined members shall have their faces on the same side.

In determining whether a tenon shall be shouldered on four, three, two or only one side, there is often room for choice. On the other hand, certain situations demand but one treatment. Fig. 381 shows a top rail with tenons shouldered on four sides. In Fig. 382, the top rail has tenons shouldered on three sides. An examination of the assembly will show that the latter is given an extraordinary relish or "cut away" on the upper edge of the rail that the mortise may not come so near the upper end of the post with a consequent weakening of the wood about the mortise. In Fig. 381, the fact that the post extends above the top obviates this modification and the tenon is shouldered in the usual manner. These tenons might just as well have been shouldered on the sides only, on account of the narrow width of the rail.

A careful study of numerous plates in which such

structural details are shown will enable the student to design structural details for his own project with intelligence.

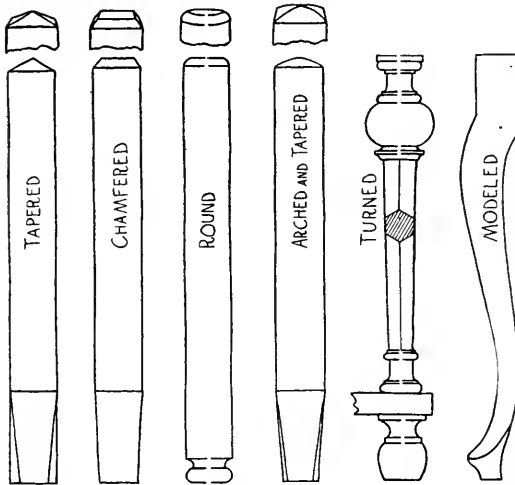

FIG. 386. DETAILS OF POST CONSTRUCTION.

The rounded top is similarly laid out but is best worked with a wood file. The file is to be held in both hands, one grasping the handle,

226. **Posts or Legs.**—In Fig. 386 are illustrated several treatments in the shaping or designing of posts or legs. The chamfered top needs no description. It is laid out with a pencil and worked like any other chamfer. The

rounded top is similarly laid out but is best worked with a wood file. The

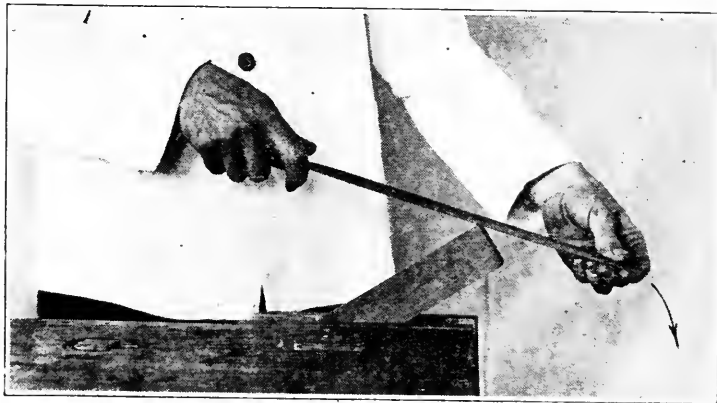

FIG. 387. USING WOOD RASP.

and the fingers of the other grasping the tip of the file lightly. The direction of the cutting stroke is indicated

by the arrow, the file being lifted from the wood on the return stroke, Fig. 387.

Fig. 388 shows the end of a post laid out for tapering, also, partly worked and laid out for the next operation. The two opposite sides are planed up like the gabled roof of a house, being first roughed off with a chisel. The final operation consists in removing these gables, thus making a hipped effect. Sometimes this tapered end is modified by having the arrises at the base slightly rounded, the wood file being used as described above.

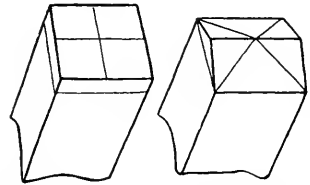

FIG. 388. POST LAID OUT FOR TOP TAPER.

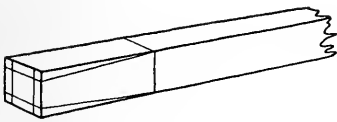

FIG. 389. LAYING OUT TAPERED FOOT.

Fig. 389 illustrates the manner of laying out a tapered foot. Two opposite sides are worked, and then the taper for the remaining sides laid off on these.

Turned legs may have their square parts prepared either before or after turning. It is a good plan, as a rule, to design the turned parts slightly smaller than the square so that planing and sandpapering may not endanger the turned parts.

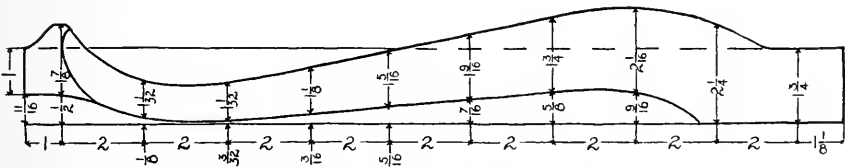

FIG. 390. MODIFIED LOUIS XV STYLE OF LEG.

In Fig. 390 are shown the proportions of a curved and modeled style of leg—a simplification of the style of Louis XV. The leg shown is for a piano bench. In work

such as this a templet or pattern should be made. This may be made of paper or thin wood. The stock for the leg consists of either one piece sufficiently large to allow the widest part to be placed, or it may be built up as in Fig. 391. (1) Face side and face edge—inner surfaces—are prepared, after which the form is traced from the

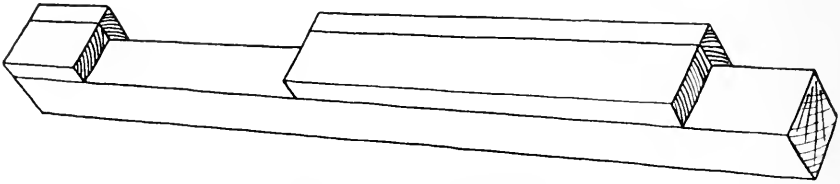

FIG. 391. BUILT-UP LEG.

templet and then sawed squarely across on the band-saw or with a turning saw. It is a good plan not to separate entirely the waste on the first sawing, but to saw almost thru the length and then withdraw the piece, reserving the clinging waste to be used in holding the piece level in sawing the second side. (2) Next, the

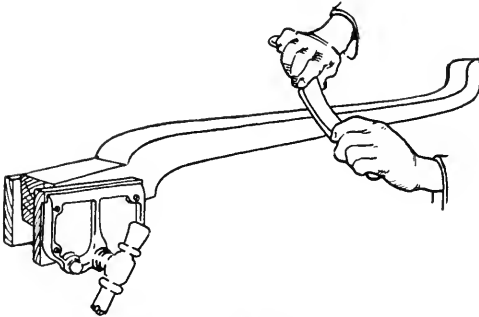

FIG. 392. MODELING.

outer arris is taken off with chisels and spokeshave, Fig. 392, and the outer surfaces rounded as shown in Fig. 461.

The mortise-and-tenon joint is often used for connecting post and rail; more frequently one finds a

doweled joint used on this type of furniture, several strong dowels being inserted.

The waste stock removed in bandsawing should be kept and used in assembling the members, Fig. 393. A

piece of cardboard placed between the waste stock and the members will prevent marring the legs.

227. Corner Fastenings.—It frequently becomes necessary to reinforce a corner joint, especially in chair seats. Fig. 394 is an illustration of one of these corner blocks. This same figure also illustrates the manner in which the longest length of tenon is obtained in a corner joint. The rails are set close to the outer edge of the post and the ends of the tenons mitered.

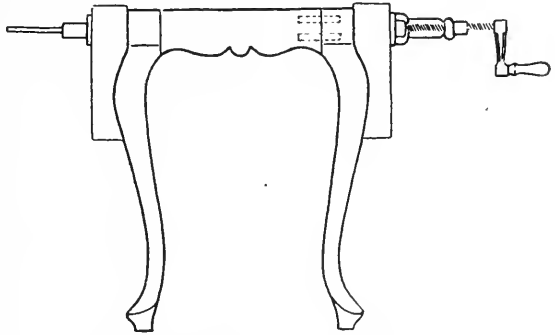

FIG. 393. CLAMPING IRREGULAR POSTS OR LEGS.

In Fig. 395 is shown an unusually strong type of construction for the front corners of a table with a drawer. Its advantages lie in the dovetailed top drawer rail, and the bottom drawer rail which is fastened to the side rails with screws, both of which tend to prevent the spread of the front legs. This top rail is frequently omitted on commercial work. Sometimes a rail will be mortised into a post and an adjacent rail doveled into this same post.

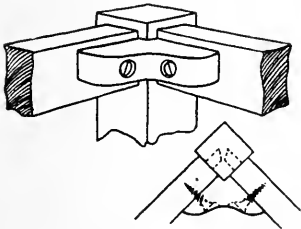

FIG. 394. REINFORCED CORNER.

228. Slats; Splats or Splads; Balusters.—Slats are the horizontal members of a chair back or seat. A splat or splad is the wide vertical member of a back. Balusters are the smaller vertical members.

Splats and balusters are joined to the main members by doweling, by tenoning with shoulders on two or four

sides, or by housing the whole ends where the slats are thin enough to do so. This last practice is somewhat

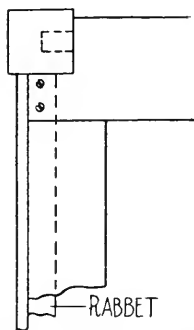
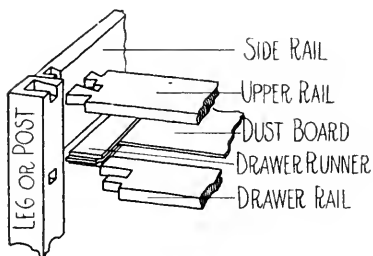

FIG. 395. REINFORCED CORNER FOR TABLES.

safer for beginners, for any variation in the distance between the rails is not noticeable as would be the case were the ends doweled or tenoned, Fig. 396.

Chair seats are best upholstered, but sometimes a heavy leather cushion is desired instead, placed upon slats. A simple method of supporting these slat ends is to groove the two opposite side rails on their inner surfaces and let the slat ends in when assembling the frame, Fig. 397, a. After the glue has hardened and the clamps

removed the grooves may be blocked between the slats with blocks of appropriate equal lengths, widths, and

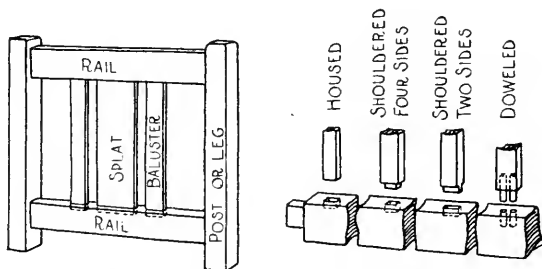

FIG. 396. JOINING SPLATS AND BALUSTERS TO RAILS.

thicknesses. This is common practice where there are many balusters to be set.

Another method is to fasten cleats to the side rails with screws and then to fasten the slats to these, Fig. 397, b. A rabbeted rail, Fig. 397, c, is used on high-grade work.

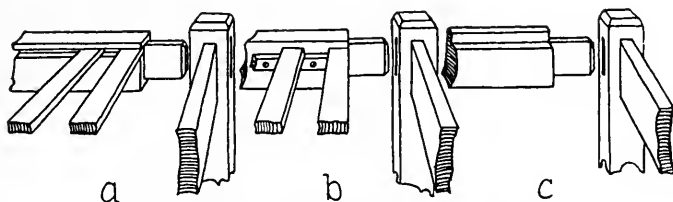

FIG. 397. PLACING SEAT SLATS.

When a seat made of woven fiber or leather requires a frame other than the seat rails, the frame is constructed as shown in Fig. 398. It may rest either upon the corner

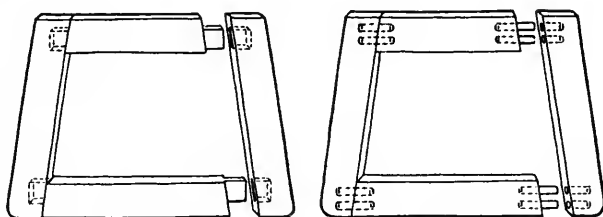

FIG. 398. CHAIR SEAT FRAME.

braces, appropriately placed, or upon rabbeted rails. Sometimes dowels are inserted in the rails and the seat allowed to rest upon their extending ends.

229. Chairs.—Chairs, except the square seat type of Fig. 399, are rather difficult of construction for beginners. A casual examination of any commercial chair will indicate the reasons. First, the custom of making the back narrower than the front, Fig. 400, necessitates cutting tenons with beveled shoulders. Second, backs are usually given slant above and below the seat rails, making for further shouldering complications. Where chairs are made in quantities and by machinery, once these angles

have been determined and the machines set, the rest is simple.



FIG. 399. CHAIRS OF SQUARE SEAT TYPE.

The beginner will do well to lay out a full-sized plan of the seat, or at least half of it, and take his angles from this with the T-bevel. He may make the seat rails and posts, and then assemble these carefully without glue, and determine the other dimensions and angles by the "rule of thumb" or try method. After he has had constructional geometry he will be able to determine these angles and lengths from his drawing.

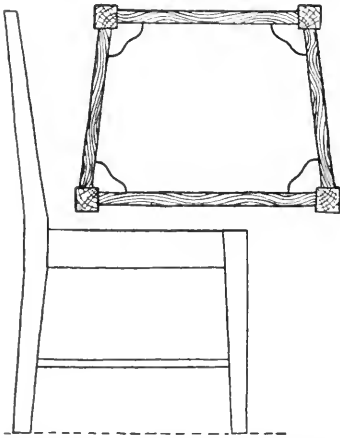

FIG. 400. COMMERCIAL TYPE OF CHAIR.

Seats are usually given a slight inclination backward and downward. This inclination may be secured after the frame is assembled by laying a straight-edge as in Fig. 401, marking and sawing. $\frac{3}{8}$ " to

$\frac{1}{2}$ " is usual for this difference in the length of front and back legs.

In the making of rockers, a sweep arc is used to lay out the curve. The rear posts should be so placed on the rockers that they will rest over that part of the rocker resting on the floor. Rockers are attached to the posts by means of tenons or dowels. The easiest method is to assemble the frame, form the rockers, and then lay



FIG. 401. MARKING CHAIR LEGS FOR LENGTH.

them in place alongside the posts, scribing upon the posts the shape the posts must take to fit the rocker. After the rockers are fitted the chair may be inverted and the dowels inserted in holes bored thru the rocker bottoms into the ends of the posts, plenty of glue being placed in the holes first, Fig. 402.

Furniture makers have no standards of curvature for rockers; neither do they have any standards for flare of seat or inclination of backs.

Rear posts, square in section, are, as a rule, sawed out of solid stock. Back slats which are curved may be

sawed from the block or they may be bent. If bent, the result is attained by boiling the part in water for thirty



FIG. 402. BORING FOR DOWELING.

minutes, or by applying live steam to the piece when enclosed in a tight receptacle, so made that the steam may be entered at one end and allowed to escape at the other after affecting the wood; after which the

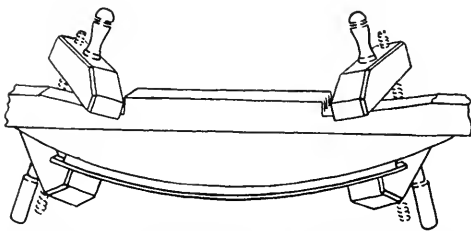

FIG. 403. BENDING CHAIR-BACK SLAT.

pieces are attached to forms or cauls previously prepared, Fig. 403. The parts are then set away in some warm place to dry. A piece of sheet metal placed upon the outside sur-

face in clamping will serve to keep the fibers intact and insure a more uniform evaporation of water.

In laying out tenons upon bent slats a straight-edge is placed as in Fig. 404, to locate the cheeks.

Also, chair rockers are formed by steaming and bending the stock.

230. Patching.—Not infrequently, in the selection of woods, small defects will have to be accepted. In such cases it is possible to better conditions by the careful removal of the defect and the insertion of a patch. Care should be taken to select a piece of wood for the patch which has the same color, grain markings, etc., as those of the piece to be repaired. (1) Cut a plug of a size just sufficient to cover the defect. Give its sides a very slight slant so that it will wedge upon being driven in. A diamond-shaped piece will be less likely to show on the finished piece. (2) Place this plug over the affected part, being careful to

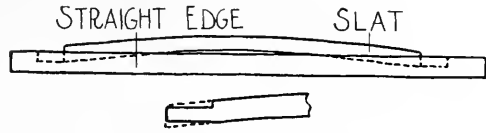

FIG. 404. LAYING OFF TENONS ON CURVED STOCK.

to have the grain match, even to the spring and summer growth lines or markings. Scribe about the plug carefully with a sharp knife, Fig. 405. (3) Remove the plug and carefully chisel the waste to a depth just sufficient to give the plug a firm hold. (4) Place glue in the mortised part and, placing a block on the plug so that the plug may not be battered, drive it in place. (5) Allow the glue to harden, then dress off the surplus stock until it is flush with the surface of the part patched.

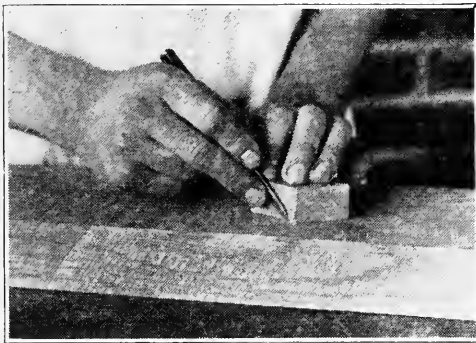

FIG. 405. SCRIBING ABOUT A PLUG.

to have the grain match, even to the spring and summer growth lines or markings. Scribe about the plug carefully with a sharp knife, Fig. 405. (3) Remove the plug and carefully chisel the waste to a depth just sufficient to give the plug a firm hold. (4) Place glue in the mortised part and, placing a block on the plug so that the plug may not be battered, drive it in place. (5) Allow the glue to harden, then dress off the surplus stock until it is flush with the surface of the part patched.

231. **Curved Work.**—Several methods of producing curved work are common to cabinet-work. Where the work is sufficiently large to warrant, segments are laid out by means of templets and sawed to shape on the hand-saw. These are then glued together as in Fig. 406. This core is usually constructed of some soft wood such as white pine. (2) After the glue has had time to set well, the core is worked to a true shape upon the band

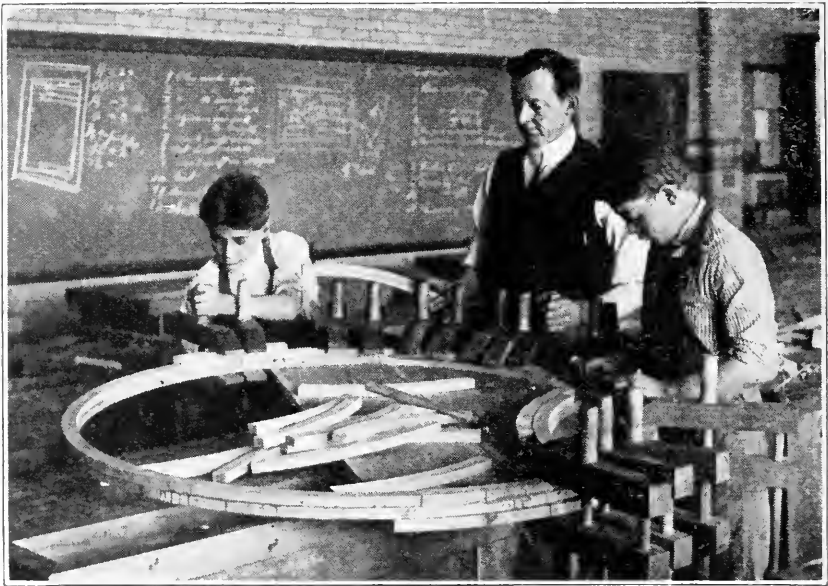

FIG. 406. BUILDING A SEGMENTAL CORE.

saw or by turning, Fig. 407. If sawed upon a band-saw, the circular plane, Fig. 65, will be made use of to smooth any irregularities caused in the sawing, also to remove the saw marks, for, if thin veneer were to be laid over a surface with saw marks left upon it, the marks would show thru the veneer. In either case the tothing plane, Fig. 77, is used to give the final touches in preparing the surface for the laying of the veneer.

In Fig. 408 is shown a method of producing curved work by means of cauls. Cauls are usually made of soft pine, the form which they shall take being determined by

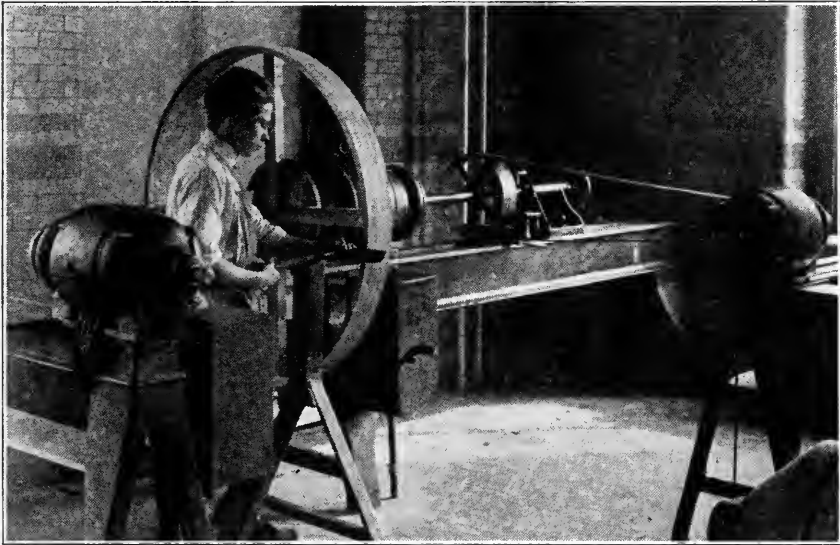

FIG. 407. WORKING SEGMENTAL CORE TO SHAPE.

the form desired in the curved piece. The stock is steamed in the usual manner, and pressure applied to the cauls by means of clamps. Fig. 409 illustrates a rather more difficult application of the same process. It shows the form and follow board, or cauls, used in shaping the body or drum of a guitar. The sides of the guitar will be made in two parts. These are drawn to place on the sides first, after being steamed. After this, the loose ends are drawn to place by means of the forms having the screws thru them. Where great pressure is required, bolts take the place of screws. The stock for such work

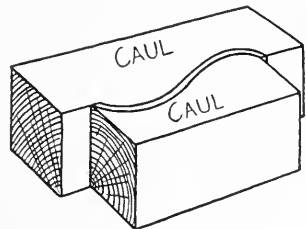

FIG. 408. CAULS.

as this is thin, not over $\frac{1}{8}$ ". Ten minutes steaming with live steam, with four days allowance for drying, is required. The loose ends are fastened to the glue blocks as shown after being fitted.

Laminated stock is made use of in curved work as well as plane. This stock is made up of layers of thin veneer glued just before being placed in the cauls or clamps. (1) Prepare the cauls, form and follow board. (2) Prepare a piece of thin stock for the core; glue-size it after tooth-ing it. (3) See that the clamps are ready; then heat the cauls to as great heat as the wood will stand without scorching. (4) While these cauls are heating apply

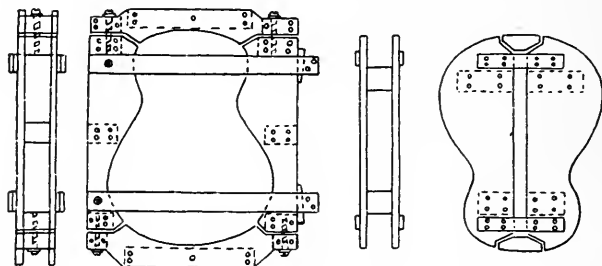

FIG. 409. FORM AND FOLLOW BOARDS IN CAUL WORK.

the glue to the core and allow it to set slightly to prevent the veneer's slipping. Veneer pins, small brads, may be used in addition, if necessary. Place the pins so that the holes, left upon withdrawing the pins, after the glue has set, will not show. (5) Apply the cauls and clamps. The drying process may be hastened in many cases by re-heating the cauls at intervals of several hours. Paper should be placed over the veneer to prevent its sticking to the cauls because of glue forced thru the pores of the wood. A piece of heavy cloth, as baize, placed over the paper will serve to press all parts of the veneer to the core. Cauls should be so made that the pressure shall

come upon the center of the veneer first, that the glue may be expelled and not form "pockets."

In laminated stock the grain of the veneer will extend at right angles to that of the core. For sharp curves the grain of core and veneer will be laid parallel, and thin veneer and core used.

232. Veneering.—Veneers are prepared in two ways—by sawing, and by cutting them with a knife. The first kind is known as saw-cut. Such veneers vary from $\frac{1}{32}$ " to $\frac{1}{16}$ " in thickness. The second kind, known as knife-cut, are thinner, varying from $1/100$ " to $1/50$ " in thickness.

Knife-cut veneer is obtained by revolving a well-steamed log about two centers, as in a lathe. Underneath the log is a knife the full length of the log so adjusted that it takes a continuous slice from the surface of the log as it revolves. This kind of veneer is also known as rotary-cut veneer. By this method, veneers of any width may be obtained, and the rotary-cut gives to the grain a most striking appearance.

In selecting veneer cores, a very hard wood should not be laid upon a very soft core, the soft wood absorbing too much of the glue.

In preparing the core (1) the surface should be made smooth, any depressions being plugged with wood or, in the case of slight crevices, filled with sawdust and glue. (2) The tothing plane should be used to score the surface both up and down the grain and in all directions. (3) A thin coating of glue should be applied and allowed to dry, after which it should be tothed again if any irregularities appear. (4) Tooth the veneers should there be saw-marks or other unevenness on their reverse surfaces.

Rotary-cut veneers, being very thin, are best cut to size by means of a sharp knife and a straight-edge.

Sawed veneers are usually laid by means of cauls.

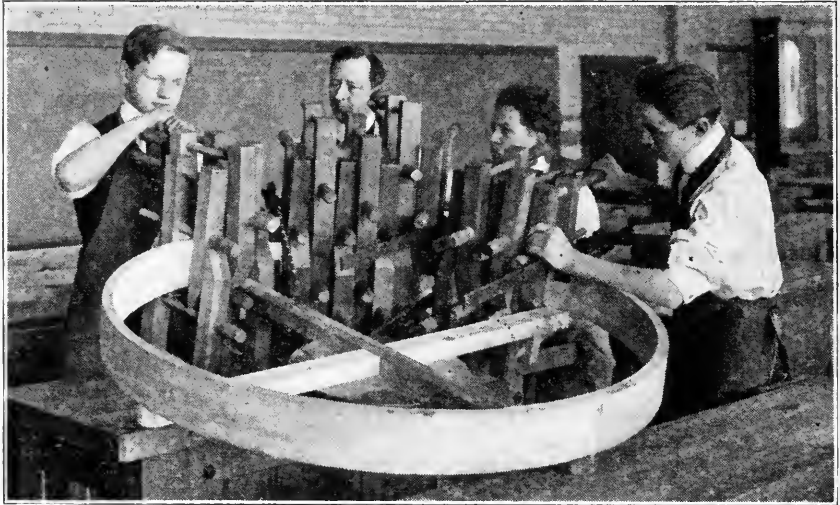

FIG. 410. APPLYING VENEER TO SEGMENTAL CORE.

Fig. 410 shows a table rail being veneered upon built-up segments, a metal caul of zinc being used on the convex surface. Wood cauls are better than metal in many ways. There is danger of getting the metal caul too hot, and more clamps are needed to produce a contact between core and veneer. Metal cauls too hot to be handled with the bare hands are too hot for the veneer. The advantage of the metal caul is obvious.

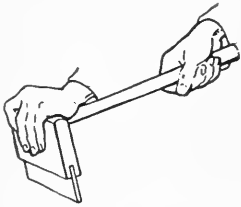

FIG. 411.
VENEER HAMMER.

Rotary-cut veneers are frequently laid with a veneer "hammer." This tool, Fig. 411, is a piece of scraper steel rounded slightly so that it will not scratch the surface of the veneer, set into a wood head so shaped that the left hand may be

used to apply pressure while the right hand grasps the handle and directs the movement. It is in reality not a hammer at all, and the process is not one of hammering but rather of squeegeeing as in mounting photographic prints.

(1) Cover the core with hot glue, fairly thin and free from grit and lumps. (2) Apply quickly, and then lay the veneer, brushing with the hand from the center out toward the edges. (3) Dampen the surface of the veneer with hot water and a sponge and lightly work the surface with a well warmed flat-iron, working from the center outward. The purpose of the hot iron, like the heating of the cauls, is to soften the glue so that later it may be worked out to the edge. Work rapidly. (4) Next, using the hammer as shown in Fig. 410, work the surface of the veneer until all air spaces have been driven to the edges.

Where air spaces cannot be removed by the method just described, and where blisters have formed upon a dried veneer surface, it will be necessary to prick the veneer with a sharp, thin knife along the grain to allow the air to escape. After this, the hot iron in connection with the veneer hammer is used to lay the raised place.

Where wide pieces are to be veneered the veneer should be cut somewhat larger than the core to be covered to allow for shrinkage in drying.

In veneering end grain the veneer should be placed with the grain extending from broad surface to broad surface to allow for shrinkage in the core, and two or three sizing coats of glue must be applied to the end grain of the core to seal the pores.

The "pull" of the veneer when drying may be partly equalized by laying the veneer on the heart side of the core. Dampening the back of the core slightly when sizing the reverse surface preparatory to gluing the

vener is another device to prevent warpage. The heating of both caul forms is another aid. Care in keeping the work away from uneven draughts, either hot or cold, and in keeping the parts clamped until well dried is necessary.

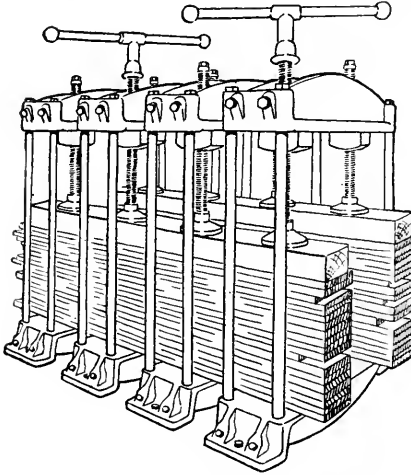

FIG. 412. VENEER PRESS.

Fig. 412 is an illustration of a veneer press, or rather a combination of several small presses.

233. Clamping Table Tops.—Where a table top is to be hand-surfaced after being put together, the whole may be clamped at one operation. If the top is to be surfaced on a

machine, it may be necessary to glue it in two parts and surface these before assembling them, depending upon the width of the top and the size of the planer bed.

If hot glue is to be used, two persons should work together that the clamps may be adjusted before the glue has had time to set. As in all other clamping, everything should be prepared to facilitate the clamping, once the glue has been applied. Clamps should be laid in place, the jaws set approximately, and blocks laid in convenient places, if needed. The screw jaw should be drawn back as far as possible. Plan to have the division of labor such that

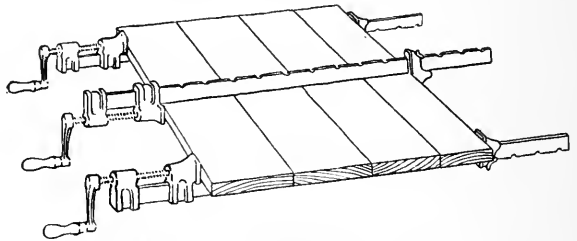

FIG. 412a. CLAMPING TABLE TOP.

one person shall be a help and not a hindrance to the other. The clamps are to be placed as in Fig. 412-a. The placing of some of the clamps on the opposite side is done to equalize the unequal pressure of the other clamps, due to the fact that the jaws of such clamps seldom apply the pressure centering. Since table tops are glued up before edges or ends are worked, it is not absolutely necessary to use blocks between the clamp jaws and the edges of the table. The slight marring of the jaws will be removed in the final squaring of the top.

234. Surfacing Table Tops.—In selecting stock for a top, at least $\frac{1}{8}$ " should be allowed for surfacing. The surface is first roughed off by cross planing, Fig. 413, and the wind removed, after which it is smoothed by planing along the grain. If care has been taken in selecting and placing the grain, as directed in the making of a glue joint in a previous chapter, little difficulty should be experienced in surfacing.

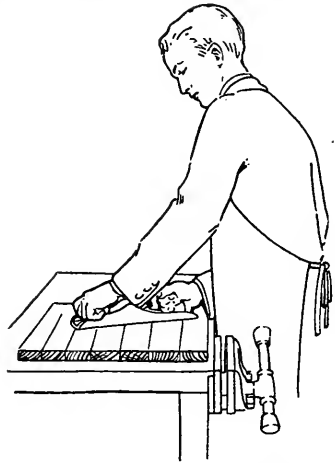

FIG. 413. CROSS PLANING.

In surfacing on a machine, where the machine is too narrow to receive the full top, the top may be glued in two or more parts, and a face surface prepared on each by running over the hand jointer. They may also be run thru the planer and worked nearly to thickness. After this they may be glued, and the remaining work thereby greatly diminished if care is taken to keep the face surfaces even in clamping.

235. Clamping Framed Structures.—No small amount of ingenuity may be displayed in clamping up various types of furniture. In general, the most intricate opposite

sides or ends are glued up one at a time and the glue allowed to harden on these before the remaining sides are placed. By properly looking ahead the student may so plan his work that no time need be lost waiting for glue to set. It is best, as a rule, to get every part ready and fitted before gluing any of them. Where, however, the clamps are in great demand and must be kept in constant use, the student may generally clamp up certain parts without endangering the fitting of the remaining parts. In Fig. 383, for illustration, the two ends of the piano bench may be got ready and glued up. The rails and top may be worked while the glue is hardening upon these ends. Or, the pieces forming the top may be glued together first and the glue allowed to set while these end members are being prepared.

The steps taken in assembling simple framed structures are comparatively easy to perform, yet in no other part of cabinet work does the beginner seem to experience more discouragements. This is due mainly to the fact that he does not appreciate the necessity for making certain simple, but very important tests, and frequently does not know how to make necessary adjustments of his clamps to remedy the defects which the tests indicate, or has failed to have everything in readiness and right before applying the glue. Glue, especially hot glue, upon intricate assembly requires the most systematic and rapid, but careful, manipulation. (1) If in doubt, see that every member fits properly, even to the extent of first assembling without glue. (2) Have the various mortises and tenons marked plainly so that no time need be lost in locating them when gluing. (3) Have the frame laid out in the order in which the parts are to be fitted and, as soon as a part is glued, place it where it belongs in the lay-out. (4) Learn to work with a

partner. Let him assist in the gluing and in the assembling. (5) Have an abundant supply of short, smooth blocks ready to insert between the clamp jaws and the frame. (6) Have the clamps laid just where they will be needed when the frame is laid in them after gluing. (7) Let the partner attend to one clamp jaw and its block and the worker attend to the other jaw of the same clamp and its block. (8) Adjust the clamps so that the whole frame may be brought together without racking, that is, do not attempt to draw a clamp up tight all at once where other members are hindering, but apply the other clamps and work each in turn.

236. Adjusting the Clamps; Clamping a Section.—Too many beginners fail to appreciate that the operation described in the section just preceding marks but the beginning of the clamping or assembly process, and many a good piece of work is spoiled because of this.

Very seldom will one find clamps with jaws so placed that they will draw the members up square to the rails. Even were the manufacturers to build clamps so that they would do this, the unnecessary strain to which beginners subject the clamps would spring the bar so as to make the same caution necessary.

The better types of clamps are constructed as in Fig. 414, with the screw head made fast to a guide which runs in slides on the clamp bar. Where this guide is not present the screw jaw and its head tend to spring away from the bar as the screw is extended thru the head. In either type, however, attention must be given to the way in which the jaws press upon the members being clamped.

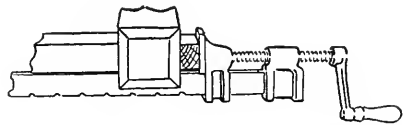

FIG. 414. USE OF BLOCK TO ADJUST POST IN CLAMP.

In clamping up a section the first time, place the blocks as near center as possible, and do not take time to make finer adjustments until all the clamps have been attached to this section, Fig. 414. After the clamps have been applied, without loss of time, test each rail by placing the try-square, as in Fig. 415, to see that it squares with the post. Seldom will it be found to do so even tho the shoulders are cut accurately. Let the partner

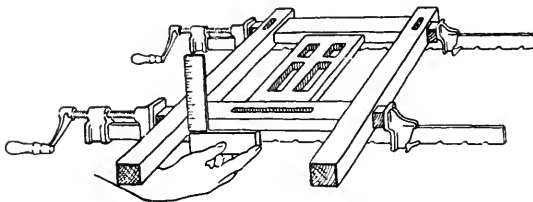

FIG. 415. TESTING POST FOR SQUARENESS TO RAIL.

test at one end and the worker at the other. When both have tested, release the clamp so that the blocks may be moved and let each adjust his block either toward or away from the clamp bar as the case demands.

Another way to adjust this pressure is to leave the block alone but to slip a sliver—a variety of thicknesses should be at hand—between the block and the jaw of the clamp, either near or removed from the bar of the clamp as required in order to exert the pressure at the desired spot.

Test again after the clamp has been tightened and repeat the process until each post is square to its rail.

Next, test the frame, as in Fig. 416, to see if the frame is square. Place the square against a post and a rail. If the frame squares with one post try the other. Sometimes slight irregularities in rail or post cause difficulty in securing a fair test from each side. Look for the cause and if too late to remedy, and the difference is

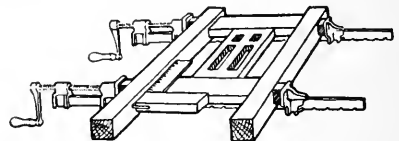

FIG. 416. TESTING FRAME FOR SQUARENESS.

slight, divide the difference between the two sides. Usually any lack of squareness may be remedied by tapping on the end of one of the posts. Place a block thereon so as not to mar the wood. If this proves insufficient a clamp must be applied as in Fig. 417. A very little pressure will be sufficient in most cases.

Third, sight the section to see whether it is in wind or not, Fig. 418. Usually the wind that will be found may be removed by twisting the frame with the hands. Set the section away so that it will not be sprung in wind again thru its own weight improperly supported.

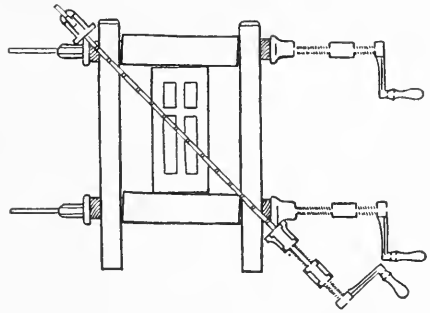

FIG. 417. DIAGONAL CLAMPING.

In clamping thru tenons, place the pressure immediately beside each side of the projecting tenon. This



FIG. 418. SIGHTING A SECTION FOR WIND.

is best accomplished by cutting grooves in the clamping blocks of sufficient depth to allow the tenon end to enter when fully clamped. Adjustments are best made here by

clamping slivers between the block and clamp jaw instead of trying to shift the block.

237. **Assembling the Sections.**—In clamping up sections, Fig. 419, care must be taken in applying the pressure to see that the glue joints of the first section

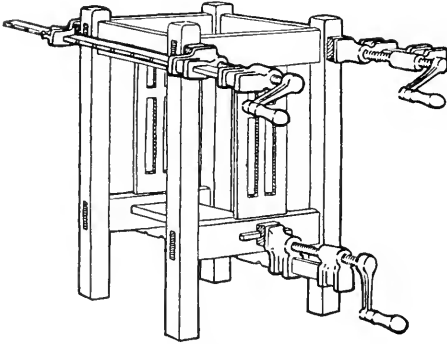

FIG. 419.

CLAMPING SECTIONS TOGETHER.

are not broken thru the application of the pressure too greatly "off center." Do not draw the clamps much until the try-square test is made to see that the rails are at right angles to the post, Fig. 415. Shift the blocks

or insert slivers between blocks and clamp jaws until the proper result is obtained as indicated by the try-square test.

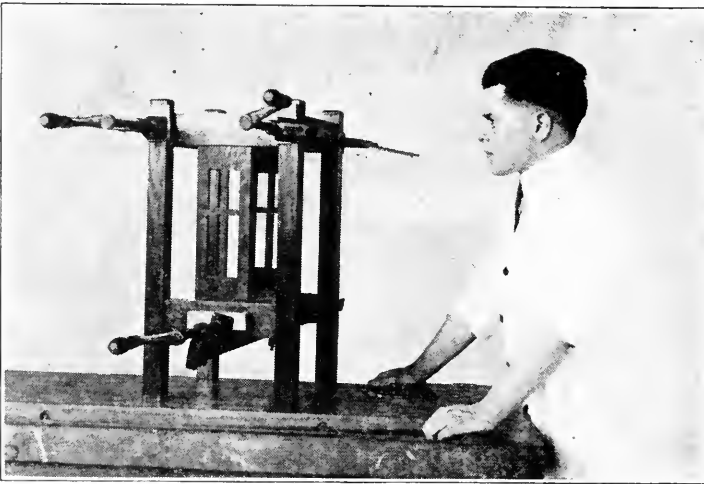

FIG. 420. SIGHTING FRAME FOR WIND.

Also test as in Fig. 416. Then test by sighting over the frame, as in Fig. 420, to see that the frame is out of

wind. Wind and lack of squareness in a frame may be removed frequently by merely shifting the clamp to a slight angle, Fig. 421.

The final test, and a very important one, is the measuring of the diagonals to see that the frame is square, one section with another. On small pieces, a square may be used to make this test. On large pieces, a square may be used to make this test. On large pieces it is best to take two sticks and, using them as an extension rule—an extension rule may be used if long enough—measure the diagonals, Fig. 421-a. Adjust until the diagonals are equal, either by attaching a clamp along the longer diagonal or by cutting a stick the length of the proper diagonal and forcing it between the posts along the shorter diagonal, Fig. 421-b.

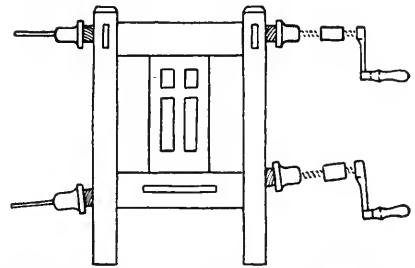

FIG. 421. SHIFTING CLAMP TO SQUARE FRAME.

238. Scribing the Posts.—After the clamps have been removed the chair, stool, or whatever it may be, should be placed upon a surface table and the legs scribed to fit the same. The top of a universal saw table will serve as a surface table for chairs and small objects. For larger objects a large table will be required. (1) Level the top of the frame—

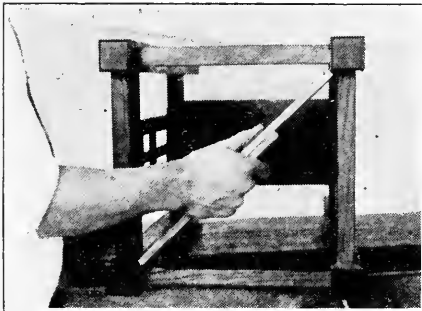

FIG. 421-a. TESTING FRAME FOR SQUARENESS BY MEASURING DIAGONALS.

it is taken for granted the surface table is level—by placing slivers under any posts which may be low or short. (2) When the top is leveled, set the dividers an amount

which it is desired to remove from the legs and scribe all the posts as in Fig. 422. (3) Saw or plane the posts as indicated by the scribed lines.

239. Clamping Miters.—In Fig. 423 is shown a device for clamping mitered members. It is known as a column clamp. Blocks of wood

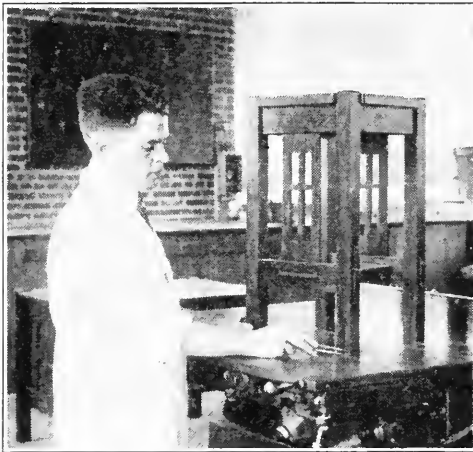

FIG. 422. SCRIBING LEGS TO LENGTH.

the clamping has been done by driving the fasteners entirely in, the ends being first squared.

For clamping mitered picture frames the most convenient and efficient clamp will be found described in Section 1-29. This is a combination of clamp, miter-box and nailing frame.

240. Fastening Tops.—The essential thing to remember in fastening tops is that, whatever the type of fastening, allowance must be made for shrinkage and

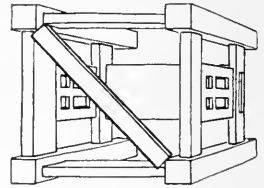

FIG. 421-b. ADJUSTING DIAGONALS.

should be placed between the chain and the stock to prevent injury to the stock. The members are first glued and assembled, being held in place by means of pinch dogs or corrugated fasteners lightly driven. The joints may be reinforced after

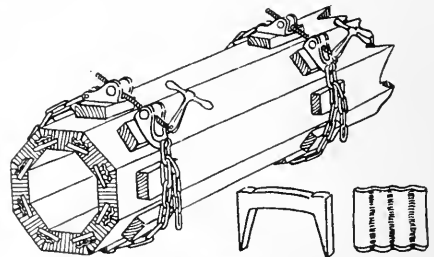

FIG. 423. CLAMPING MITERS.

swelling. On small tops where shrinkage and swelling are not great, small angle irons may be used to advantage. These are fastened to the rails and to the top by means of screws. The table, or whatever piece of furniture it may be, is turned upside down and the irons placed at regular intervals, Fig. 424.

Fig. 424 also shows two methods of attaching tops directly by means of screws.

In the first type a hole is bored into the rail upon the inner surface. A small hole is bored down thru the edge to meet this hole and at an angle which will permit the screw to be inserted thru the hole in the side of the rail. In the second type the gouge is used to make an opening for the screw head.

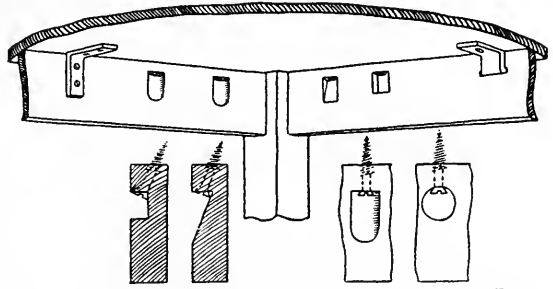

FIG. 424. FASTENINGS FOR TABLE TOPS.

For wide tops the best fastening is the wood button, Fig. 425. This style of fastening permits quite a range of movement of the top in shrinking and swelling without danger of cracking or checking. In machine work the groove in the rail is plowed, as a rule, the full length of the rail.

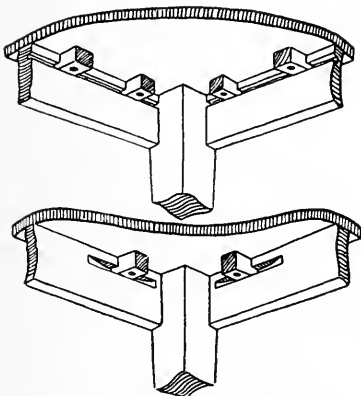

FIG. 425. BUTTONS USED TO FASTEN TABLE TOPS.

241. Drawer Runners and Guides.—Drawer runners and guides are variously constructed. In the better types

of construction the drawer bearers are framed as in Fig. 426. The dust board serves not only to keep the dust

out but also to prevent access to a drawer by the removal of the drawer just above it. The guide in this case should be glued to the runner or bearer.

In cheaper work guides are often formed as in Fig. 427, being doweled to the back and to the drawer rail. In Fig. 428 is shown a method of carrying a middle guide with bearer. These are doweled to the rails.

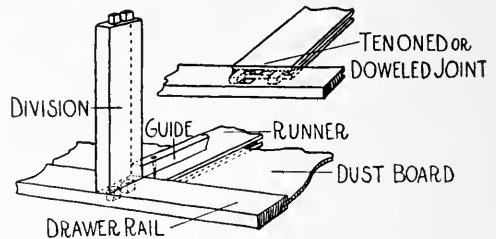

FIG. 426. DRAWER RUNNERS AND GUIDE.

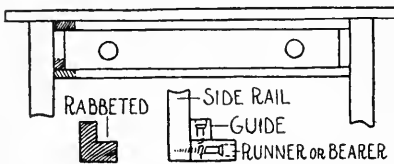

FIG. 427. DRAWER RUNNERS AND GUIDES CHEAP CONSTRUCTION.

242. Drawer Construction.—The front of a drawer is usually made of thicker stock than the other parts, Fig. 429. For example, if the front were to be made of $\frac{3}{4}$ " stock the sides, back and bottom would probably be made of $\frac{3}{8}$ " material. Drawer fronts are always made of the same material as the rest of the cabinet or desk while the sides, back and bottom are usually made of some soft wood such as yellow poplar.

Fig. 430, A, illustrates a very common method of fastening the drawer sides to the front. This form is used mainly upon cheap or rough construction. It is commonly known as a rabbeted joint. The half-blind dovetail, Fig.

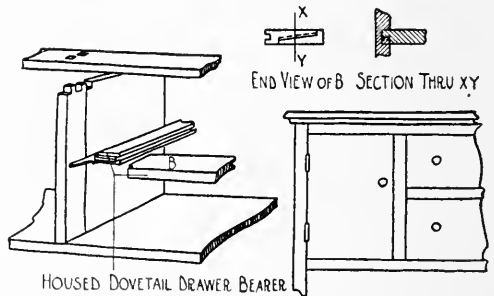

FIG. 428. DETAIL OF FRAMING DRAWER DIVISION.

430, B, is a better fastening, by far, and is used almost exclusively on fine drawer construction.

243. Directions for Rabbeted Corner.—The rabbeted joint, Fig. 430, A, sometimes called a rebate or ledge joint, is made as follows: (1)

Line across the face side of the drawer front at a distance from the end equal to the thickness of the drawer sides; also, across the edges to the approximate depth of rabbet.

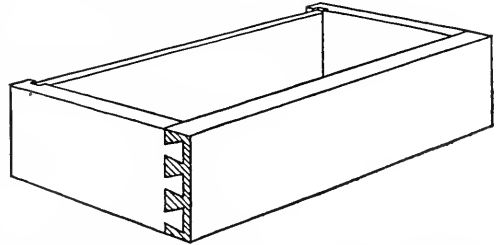

FIG. 429. THICKER STOCK FOR FRONT OF DRAWER.

(2) Set the gage and gage on ends and edges as far as the lines just placed, for the depth of rabbet. (3) Cut the sides of rabbet, paring across the grain as in cutting the dado. Fasten by nailing thru the drawer sides into the front, not thru the front into the sides.

244. Directions for Dovetail Corner.—The front of the drawer should be laid out and cut first. (1) Gage on

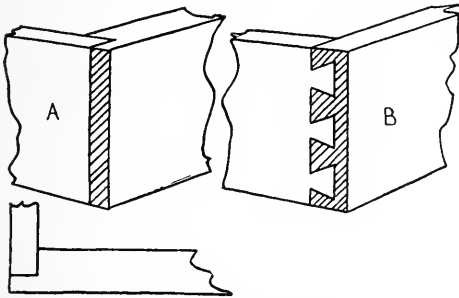

FIG. 430. A, COMMON METHOD. B, HALF-BLIND DOVETAIL.

the end the distance the drawer side is to lap over the front. (2) Without changing the setting of the gage, hold the head of the gage against the end of the drawer side and gage on both broad surfaces. Ordinarily, one

should not gage across the grain of the wood nor should the head of the gage be held against other than a face. A little thought will show why exception has been made in this case. (3) Square a line across the face side—the

inside surface—of the drawer front at a distance from the end equal to the thickness of the drawer side. This line gives the depth of mortise for the tails. (4) The groove for the drawer bottom having been cut, or its posi-

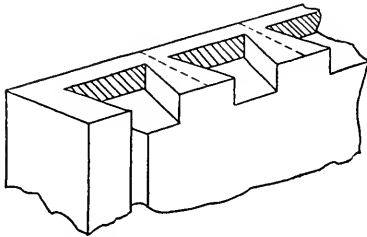

FIG. 431. CENTER LINES FOR TENONS.

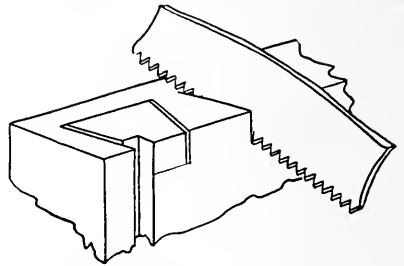

FIG. 432. SAWING TO KNIFE LINE.

tion marked on the end of the front, lay out on the end the half tenons at both edges so that the groove shall come wholly within a tail mortise. The amount of flare at which to set the bevel is given in Fig. 268. (5) Determine the number of tenons wanted and divide the space between the flares just drawn into the required number of equal parts, and draw center lines for the tenons, Fig.

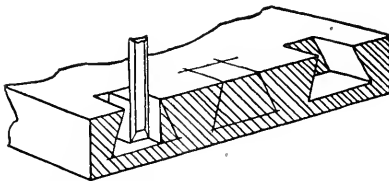

FIG. 433. CHISELING OUT MORTISE.

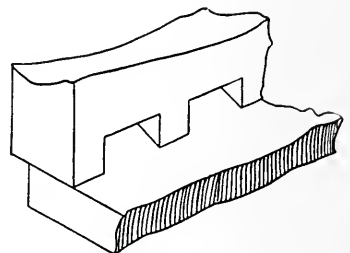

FIG. 434. POSITION FOR MARKING MORTISES.

431. (6) With the bevel lay off to either side of these center lines the sides of the tenons. (7) Carry these lines down the face side to meet the line previously drawn to indicate mortise depth. (8) Saw exactly to the knife

lines, cutting, Fig. 432, the kerfs out of the mortises, not the tenons. (9) Chisel out the mortises. Fig. 433.

The corresponding mortises and tails may now be laid out on the drawer side and worked. (10) By superposition, Fig. 434, mark out the shape of the mortises to be cut in the sides. (11) Saw and chisel these mortises.

245. Directions for Drawer.—(1) Square the different members to size. (2) Groove the front and sides of the drawer to receive the drawer bottom. These grooves should be made somewhat narrower than the bottom is thick to insure a good fit. The under side of the bottom, later, may be gaged and beveled on the two ends and the front edge, Fig. 435. (3) Lay out and cut in the drawer sides the dados into which the ends of the back are to be fitted, Fig. 436. (4) Lay out

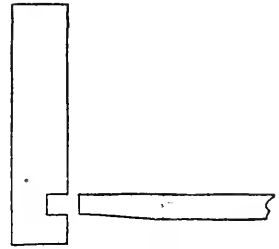

FIG. 435.
BOTTOM BEVELED.

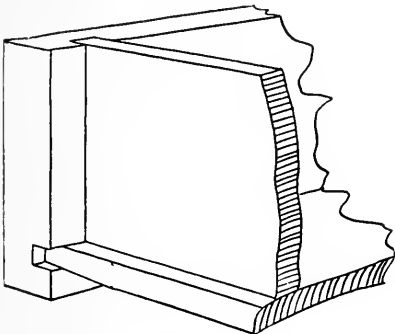

FIG. 436.
CONSTRUCTION OF BACK.

and cut the joints on the front of the drawer. (5) Get the bottom ready; that is, plane the bevels on the under side as suggested in (2). (6) Assemble the members dry to see that all fit properly. (7) Take apart; glue the joints by which the sides are fastened to the front and the joints by which the back is fastened to the sides. Glue the bottom to the front of the drawer but not to the sides or back.

Sometimes on large or rough work nails are used instead of glue to fasten the members together. In this

case the front, sides and back are put together, the back being kept just above the grooves in the sides. The bottom is then slipped in place under the back. It is fastened to the front of the drawer only. Especial care should be taken in squaring the bottom for the squareness of the drawer is dependent upon this.

246. **Paneling.**—Often it is desired to fill in a rather wide space with wood. To offset the effects of shrinkage, winding and warpage, a panel rather than a single solid piece is used. By increasing the number of panels a space of any size may be filled. Fig. 437.

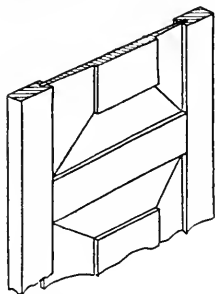

FIG. 437. FILLING ANY SPACE WITH PANELS.

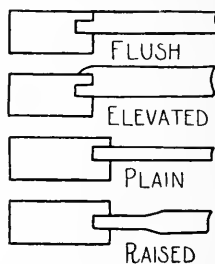

FIG. 438. PANEL SURFACES.

Panel surfaces are formed or shaped in a number of ways. In Fig. 438 are shown several styles. The plain panel and the raised panel are used for similar purposes, the raised panel being considered somewhat more ornamental. The flush panel is used in construction where it is desired to have the panel surface even with, or flush with, the rails and stiles. The elevated panel is used mainly upon the tops of chests.

In assembling panels, care must be taken that no glue shall get into the grooves in such a way as to bind them.

The panel must be able to move in the grooves when swelling or shrinking. A touch of glue may be placed, however, in the groove at the middle of the panel at either end to hold the panel centered in its frame when swelling or shrinking. Using any other place in the grooves, intentionally or accidentally, will defeat the very purpose of the panel. Sometimes the grooves are oiled before assembly; glue will not adhere to an oiled surface.

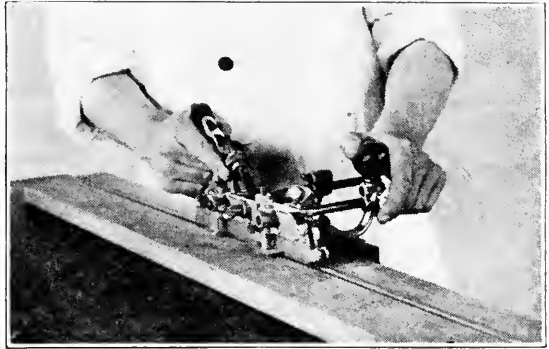

FIG. 439. PLOWING GROOVES.

In making of doors, frames for panels, etc., enough extra stock must be added to the stiles and rails to permit their being trimmed when fitting them in place. $\frac{1}{4}$ " to each member is usual.

247. Cutting Grooves.—Grooves for panels are best cut by means of the panel plow or combination plane. It is not necessary to gage for the sides of the groove; the adjustments of the plane are such as to give the proper depth and location, when once set, and a cutter of the width equal to that of the desired groove inserted. The fence of the plane must be held against one or the other of the faces, Fig. 439.

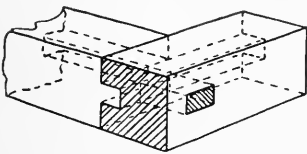

FIG. 440. HAUNCHED MORTISE-AND-TENON.

248. Haunched Mortise-and-Tenon.—A groove must be plowed the full length of a piece to work it to

advantage. Where a mortise-and-tenon joint is to be made in which the grooved surface is to become a part,

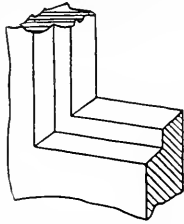

FIG. 441. RABBETED CORNER.

the tenon must be so cut as to allow its filling the groove. The mortise should be cut before the groove is plowed. The tenon, after being worked the full width, is gaged from the face edge to a width equal to the length of the mortise and worked to that size. Fig. 440.

Especial care must be taken in gluing up the frame that no glue shall get into the grooves or on the edges of the panel.

249. **Rabbeting.**—Fig. 441 shows a corner of a frame rabbeted to receive a glass. Rabbets are best worked with either a rabbet plane or the combination plane. In rabbeting across the grain the spur must be set parallel with the edges of the cutter.

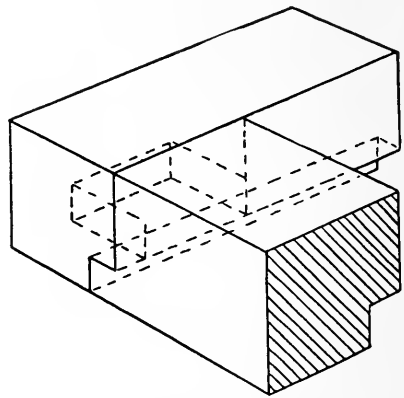

FIG. 442. JOINT FOR RABBETED FRAME.

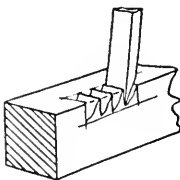

FIG. 443. RABBETING WITH CHISEL.

Since the parts of the frame are rabbeted the full length for convenience, a special joint is necessary at the corners. The mortises are cut before the rabbets are worked. The tenons are laid out so that the shoulder on one side shall extend as far beyond the shoulder on the opposite side as the rabbet is deep, Fig. 442.

Where rabbeting must be worked with a chisel alone, Fig. 443 illustrates the manner of

loosening up the wood preparatory to removing it, when the rabbet extends along the grain of the wood.

To place glass panels in rabbets, first place a slight cushion of putty in the rabbet that the glass may rest against it. A light cushion between the glass and the fillet will serve to keep the glass from breaking and will keep it from rattling, Fig. 444.

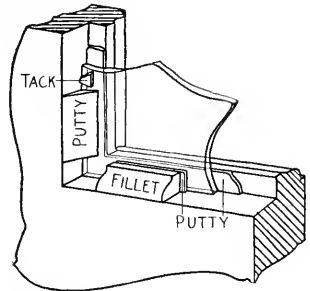

FIG. 444. PLACEMENT OF GLASS PANELS.

250. Fitting a Door.—A door is a frame with a panel or a combination of panels. The names of the parts of a door and their relative positions are indicated in Fig. 445.

(1) Mark with a try-square and saw off the lugs, the parts of the stiles which project beyond the rails. (2) Plane an edge of the door until it fits a side of the frame against which it is to be hung. If the frame is straight,

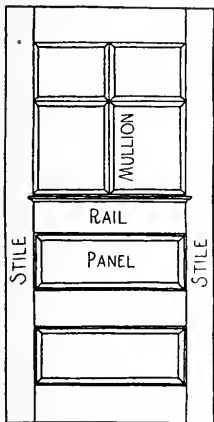

FIG. 445. DOOR.

this edge may be planed straight. It is not wise to take for granted the squareness or straightness of a frame. A test or series of tests may first be made with square and straight-edge. A mechanic, however, usually planes an edge until it fits the frame, testing by holding the door against the frame as near to its position as its size will allow. (3) Plane the bottom or top edge of the door until it fits the frame properly when the first planed edge is in

position. (4) Measure the width of the frame at its top and bottom, Fig. 446, and transfer these dimensions to the top and bottom of the door, connecting them with a straight-edge. When approaching the line, in planing,

place the door against the frame often enough to see where the allowances must be made for irregularities in the frame. (5) The length of the frame may next be measured on each side and these dimensions transferred to the door. Connect them with a straight-edge and plane and fit as was directed in the third step.

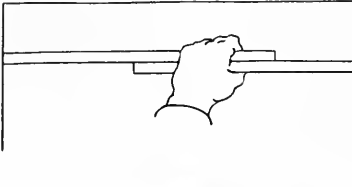

FIG. 446. MEASURING WIDTH OF DOOR FRAME.

A door to work well must not be fitted perfectly tight; it must have a little "play," the amount depending upon the size of the door.

The edge of the door which is to swing free is usually planed slightly lower at the back arris than at the front. An examination of the movement of an ordinary house door will show the reason for this.

251. Hinging a Door.—The hinges commonly used in cabinet-making and carpentry are the kind known as butts, Fig. 447. Where the door stands in a vertical position, hinges in which the two parts are joined by a loose pin are generally used. By removing the pins the door may be removed without taking the screws out of the hinge. Such hinges are more easily applied than those with the fixed pin.

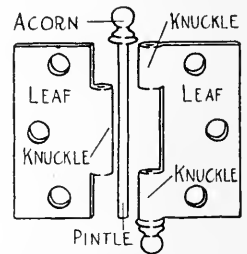

FIG. 447. BUTT HINGE.

(1) Place the door in position; keep it tight against the top and hinge side of the frame. (2) Measure from top and bottom of the door to locate the position for the top of the higher hinge and the bottom of the lower hinge. Usually, the lower hinge is placed somewhat farther from the bottom than the higher hinge is from the top. (3) With the knife or

chisel mark on both door and frame at the points just located, Fig. 448. (4) Take out the door, place the hinge as in Fig. 449, and mark along the ends with a knife. (5) In a similar manner mark the frame. Make certain that the openings on door and on frame are laid off so as to correspond before proceeding further. (6) Set the gage for the depth the hinge is to be sunk and gage both door and frame, Fig. 450. (7) Set another gage for width of openings and gage both door and frame, keeping the head of the gage against the front of the door, Fig. 451. (8) Chisel out these gains on door and frame, Fig. 452. (9) If loose-pin butts are used, separate the parts and fasten them in place. Use a bradawl to make open-



FIG. 448. MARKING DOOR AND FRAME FOR HINGE LOCATION.



FIG. 449. MARKING HINGE LENGTH.

ings for the screws. To insure the hinges pulling tight against the side of the gain make the holes just a little nearer the back side of the screw hole of the hinge. Put the door in place and insert the pins. It is a good

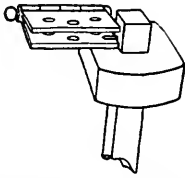

FIG. 450. SETTING GAGE FOR DEPTH OF GAIN.

mechanic who can make a door hang properly the first time it is put up. It is better, therefore, to insert but one or two screws in each part of a hinge until the door has been tried. (10) If the door hangs away from the frame on the hinge side, take it off; take off hinge on door or frame, or both if the crack is large; chisel the gain deeper at its front. By chiseling at the front only and feathering the cut towards the back, the gain needs to be cut but about one-half as deep as if the whole hinge were sunk. If the door should fail to shut because the hinge edge strikes the frame too soon, the screws of the offending hinge must be loosened and a piece of heavy paper or cardboard inserted along the entire edge of the gain. Fasten the screws and cut off the surplus paper with a knife. If plain butt hinges are used the operations are similar to those just described except that the whole hinge must be fastened

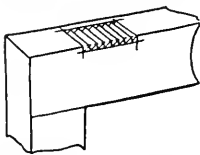

FIG. 452. CHISELING OUT GAIN.

to the door and the door held in place while fastening the hinges to the frame.

252. Locks.—Locks which are fastened upon the surface of a door are called rim locks. Those which are set into mortises cut in the edge of the door are called mortise locks. Locks are placed somewhat above the middle of the door for convenience as well as appearance. Three styles of cabinet locks such

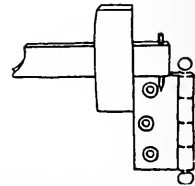

FIG. 451. SETTING GAGE FOR WIDTH OF GAIN.

as are used on drawers and small boxes are shown in Fig. 453.

The manner of applying a cabinet lock will be suggested by the lock itself. On surface locks, (1) the lock

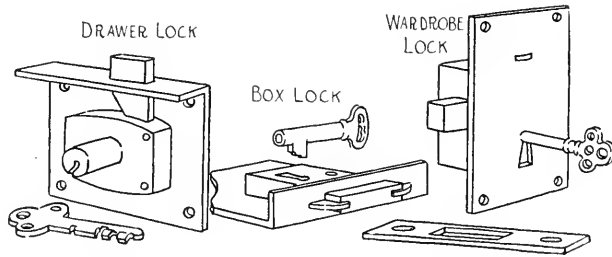

FIG. 453. THREE KINDS OF LOCKS.

is held against the inside of the door or drawer and the position of the keyhole is marked. (2) This hole is bored. (3) The lock is screwed in place, and (4) the escutcheon fastened to the outer or front surface. If a face-plate is used, the door is closed, the position marked, after which the door is opened and the plate is set. The face-plate is mortised into the frame so that its outer

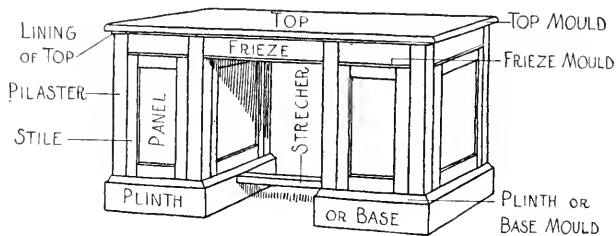

FIG. 454. NAMES OF PARTS OF A TYPICAL PIECE OF FURNITURE.

surface shall be slightly lower than that of the wood. With a lock such as the box lock, Fig. 453, sufficient wood must be removed from the mortise so that the bolt may act properly before the plate is screwed fast.

253. Carcase Construction—The term “carcase,” as used in cabinet-work, refers to any enclosing frame without doors, drawers, or fittings. There may be a lower, an upper, a right or a left carcase in a piece of furniture; or the piece may be of such a construction that but one part may be so designated.

In Fig. 454 are named the various parts to a piece of furniture. From this it will be seen that the parts to a piece of furniture take their names from the corresponding parts to a house or other building.

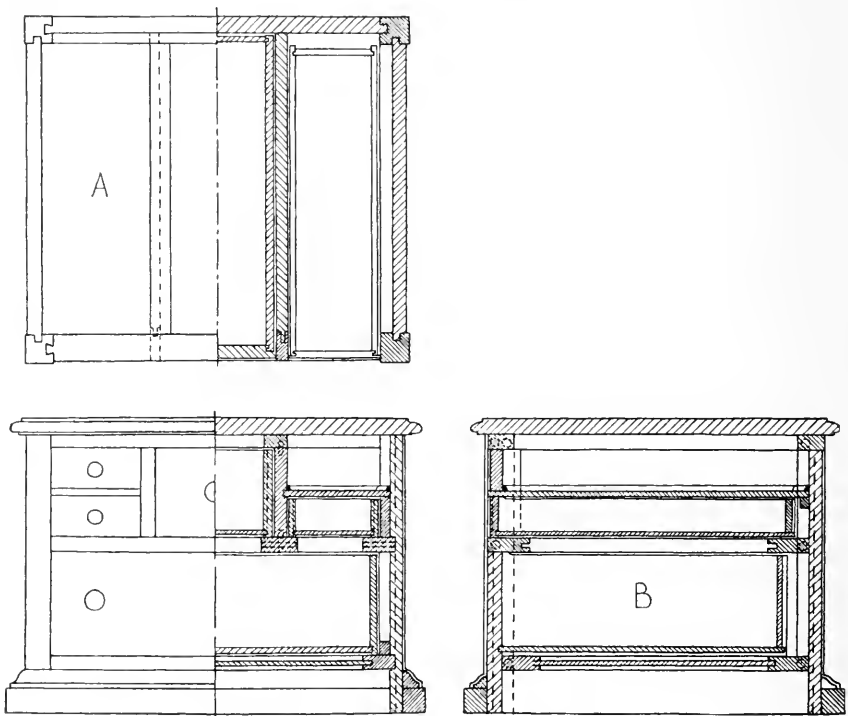

FIG. 455. COMMON TYPE OF CARCASE.

There are various ways of constructing carcasses. Fig. 455 illustrates a very common type. Frames are made to support the drawers. Grooves are plowed on the inner edges before the members of the frame are assembled

and these serve to hold the dust board, should any be used. In cheaper construction these dust boards are often omitted. In cheaper work the frames do not have the cross rails or bearers full tenoned into the stiles, stub tenons the depth of the dust board groove being made to serve the same purpose.

Usually these frames are attached to the posts by means of dowels.

The relative positions of the drawers, the manner of framing the partitions between the drawers and of attaching them are indicated in Fig. 455. The vertical partitions will be faced with stock having a vertical grain, 455-B, tho the interior portion will have a horizontal grain, 455-A. The connection between the two will be made by means of a tongue-and-groove joint.

254. Shelving.—Shelving is variously fitted to cabinets. Usually it is made adjustable. Metal stops are to be had at any hardware store which are so molded that they require only a series of holes in the side of the case into which they may be inserted, the shelf ends resting upon the projecting flats.

Another method of supporting shelving is by the insertion of ratchets in the four corners of the case with cleats adjustable to various heights. Fig. 456 illustrates several forms of ratchets.

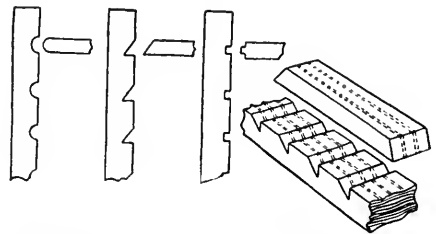

FIG. 456. ADJUSTABLE CLEATS FOR SHELVING.

(1) Secure a piece of stock large enough to make the four pieces required. (2) Plane a face side and a face edge and work to width, for ratchets other than that with the rounds. (3) Lay out and work the ratchets. (4)

Gage a thickness and rip off a piece. (5) Again plane up a face side and gage and rip; repeat this operation until the four pieces have been ripped. (6) Plane the reverse surfaces of each piece to the gage lines. The cleats may be worked in a similar manner.

In making ratchets for the cleats with the curved ends, a little different procedure will be necessary. (1) Square up a piece of stock to twice the width and thickness wanted in the cleat with enough excess stock each way to allow for ripping. (2) Lay off down the middle of the width at regular intervals and bore holes of a diameter equal to the proposed width of the cleat. (3) Rip the piece to thickness after gaging. (4) Rip the pieces which are thus obtained to width, or down thru the holes just bored. (5) Plane the saw marks off, planing to the gage lines indicative of width and thickness.

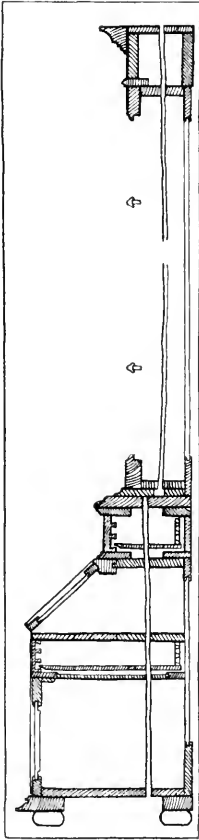

FIG. 457. ROD FOR
CABINET—
VERTICAL SECTION.

255. Rods.—It is essential in complicated cabinet construction that the shop man know with certainty just how the cabinet is to be constructed. For this purpose rods are constructed. The name is slightly misleading, the rods being flat boards of thin white wood upon which a full-sized sectional drawing is made. A cabinet may require a number of such rods, each showing full-sized detail of some part of the cabinet.

To make a rod (1) select a board of sufficient length to take a full-sized sectional drawing. The depth of the

cabinet, if it exceeds 12", may be placed on a 12" board by using a broken view and placing the dimensions of the depth on the rod, Figs. 457 and 458. (2) Smooth a surface and joint an edge. (3) With a try-square and a sharp pencil lay off the lines perpendicular to the edge. (4) With the gage lay off the lines parallel to the edge. (5) Go over all the lines with a pencil of medium lead, HB, that the rod may be distinct and easily read.

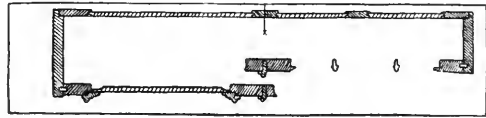

FIG. 458. ROD FOR CABINET—
HORIZONTAL SECTION.

256. Templets.—Templets or templates are full-sized patterns of irregular parts laid out on thin white wood and the outline worked to shape. The shapes are first drawn on paper and then transferred to the thin wood. Templets are made of sheet metal when they are to have very extended use.

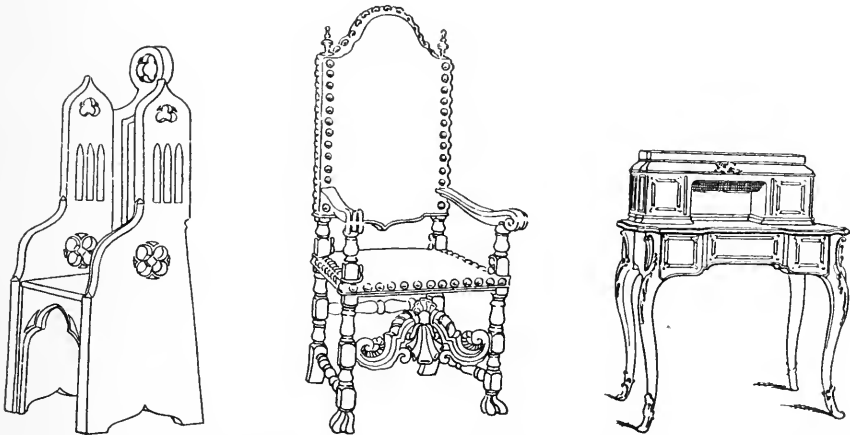

FIG. 459. GOTHIC. FIG. 460. RENAISSANCE FIG. 461. LOUIS XVI.

257. Period Furniture.—Furniture styles, like those of dress and customs, change, and like dress and customs, past styles may be known or determined by the period

or age in which they flourished. Some of these styles are designated by the name of the reigning monarch of the period in which they flourished, the predominant in-

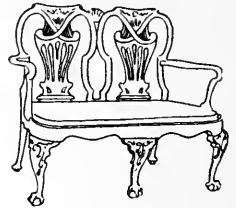
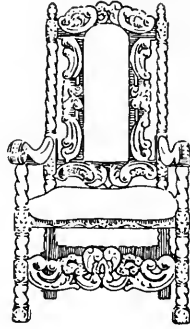
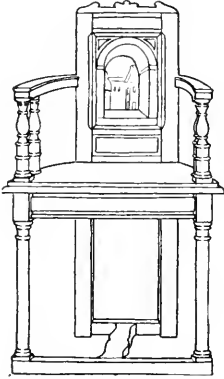

FIG. 462. ELIZABETHAN FIG. 463. JACOBEAN. FIG. 464. QUEEN ANNE

fluence of certain monarchs affecting furniture styles as well as those of dress. In other instances the influence of the designer being the stronger, the style is known by

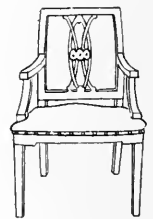
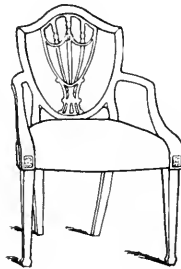
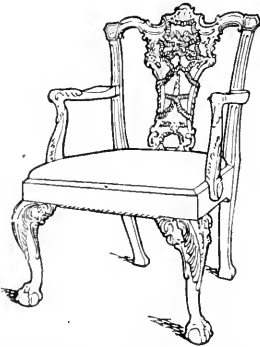

FIG. 465. CHIPPENDALE

FIG. 466.

FIG. 467. SHERATON.

HEPPLEWHITE.

his name. It is not possible in a textbook such as this to enter into a discussion of styles. Volumes have been written upon the subject and the interested student need

only make his desires known to a librarian to secure an abundant literature on the subject.



FIG. 468. ADAM.

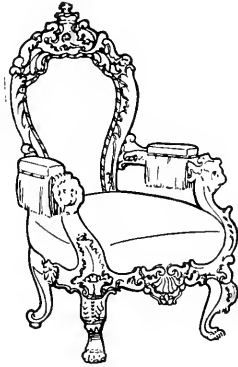

FIG. 469. VICTORIAN.

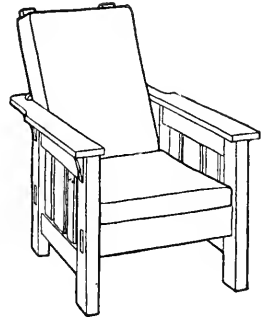
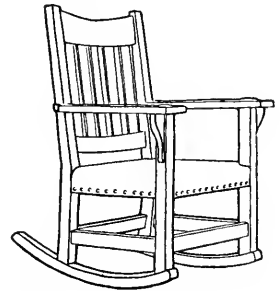

FIG. 470. MORRIS.

Without discussing the propriety of allowing past styles to influence present design exclusively in furniture construction, it may be said that people of culture should be able to recognize the chief characteristics of the more common historic forms. Figs. 459 to 471 illustrate a very few types. It must be remembered that any one style, such as Hepplewhite for example, may have a number of variations.

FIG. 471. MODIFIED
MISSION.

258. Moldings.—In shaping the contour of moldings the student will do well to investigate the work of the past. Whether or not he wishes to allow historic forms to influence his present design in structure, he will have to concede that historic moldings express very nearly the ultimate in good form and proportions. Fig. 472 illustrates a few such forms. In moldings, as in furniture types, any one style will have a number of variations.

259. **Simple Upholstering.**—(1) With a wood rasp remove any sharp arrises which might cause the webbing to wear unduly. (2) Place the webbing as in Fig. 473.

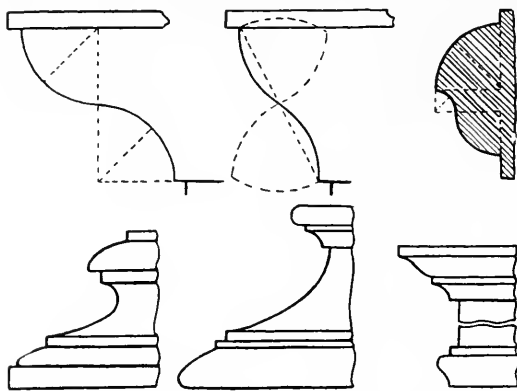

FIG. 472. HISTORIC MOLDINGS.

Note that the ends are folded over about 1" so as to give good purchase for the tacks. Fasten the loose end of the webbing to the far side of the frame, using four or five 10 oz. tacks. Using the webbing

stretcher as shown, draw the webbing firmly across the near rail, and fasten it with four tacks. Cut off the excess about 1" outside

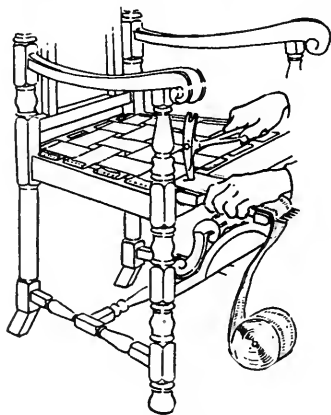

FIG. 473. PLACING THE WEBBING.

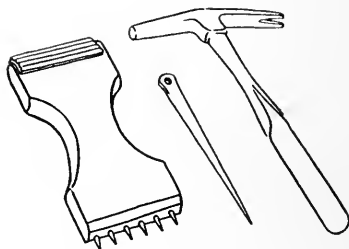

FIG. 474. WEBBING STRETCHER. REGULATOR. GUIMP HAMMER.

the tacks. Fold this end back over the tacks, and insert three more tacks thru the webbing into the rail.

Webbing may be purchased in rolls of 72 ft. of various grades in either 3½" or 4" widths. "B. F. M." is of good quality for such work as this. The guimp hammer, Fig.

474, will be found especially appropriate for work such as this.

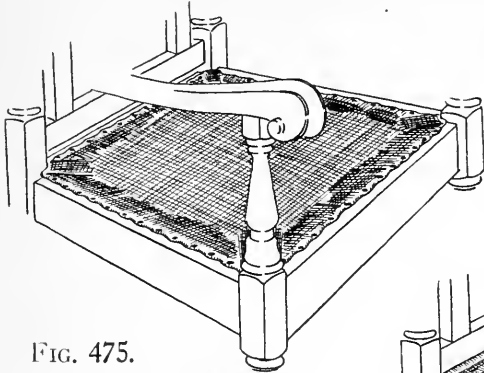

FIG. 475.
BURLAP OVER WEBBING.

such work because of its power to resist tearing or ripping, once a hole is started. Three grades are in common use, heavy (12 oz.), medium (10 oz.), light (8 oz.).

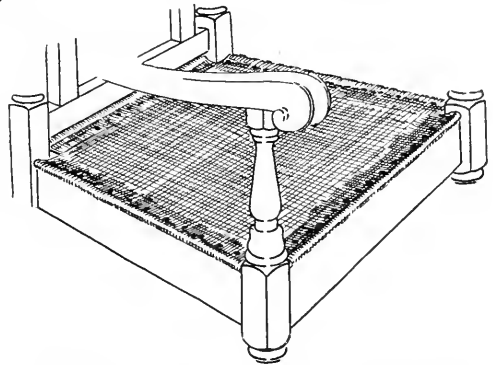

FIG. 476. ROLL OF BURLAP AND TOW
ALONG EDGE.

(4) That there may not be sharp edges, it will be necessary to place a roll of burlap and tow along the frame as shown in Fig. 476. Such edgings not only make for more comfort but also serve to prevent the coverings from being unduly worn at these places. Pick the tow until it is fluffy, then roll it into cylindrical form between the palms of the hands, and place this within the 3" strips of burlap previously prepared. Tack this burlap so that the heads of the tacks shall rest even with the outer arrises of the rails.

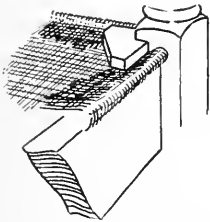

FIG. 477. CORNER
BLOCK IN PLACE.

Upon an open frame, such as the one illustrated, it will be necessary to place corner blocks that there may be a base into which to fasten the tacks which hold the cover-

ing material about the posts. Fig. 477 shows one of these blocks in place.

(5) Next, the stuffing or filling is placed. There are a number of different materials used for this purpose, such

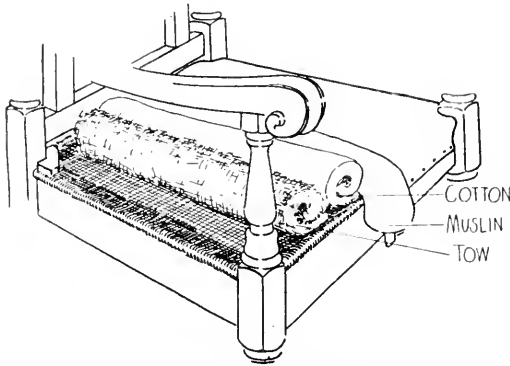

FIG. 478. WADDING.

as curled hair, tow, moss, excelsior, floss. Curled hair is best but is expensive. Wadding, Fig. 478, is a kind of stuffing formed into layers and is used to cover stuffings to give a final surface and also to prevent the

coarser materials from working thru the cover. There are various grades for each material.

Moss is sometimes mistaken for curled hair. The application of a lighted match to a small sample will quickly indicate its character. Being vegetable, it burns clean, leaving an ash. Even the novice knows how hair burns.

Whatever the material used, it should be well picked, shaken or pulled out, but not apart. Place most of the material at the center of the frame and see that all is well distributed.

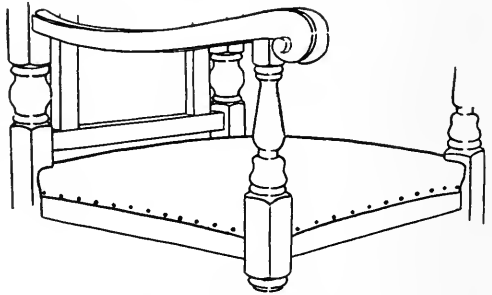

FIG. 479. MUSLIN COVER.

(6) The muslin cover is next placed, Fig. 479. Unbleached muslin is commonly used, tho duck or canvas may be used where greater strength is desired because of a lighter final cover. Upon cheaper grades of work the

outer covering is often placed directly upon the stuffing or wadding.

Begin at the middle of each of the four sides and slip-tack each with three or four tacks. Slip-tacking consists in driving the tacks but part way in that they may be easily removed where readjustment of the cover makes this advisable. Next, draw the muslin diagonally and, with the scissors, slit the cover from each corner to the inner corner of the post. Adjust any of the sides needing adjustment by withdrawing and replacing the slip-tacks. Tack the muslin permanently, beginning at the middles and working toward the ends, folding the edge of the muslin under as the work progresses. Use 3 oz. tacks, placed $1\frac{1}{2}$ " apart. After the muslin cover has been placed, remedy any unevennesses by means of the regulator, sticking it thru the muslin and wadding and moving it about to draw the stuffing where needed.

(7) The final covering is to be placed next. Such coverings may be of leather, imitation leather, or textile. In any one of these, there will be found such a variety both in color and price that judgment must be exercised in the matter of fitness to use. Leathers are expensive. Imitation leathers may be secured which look and wear well, and are reasonable in price.

Proceed in the placing of this final covering as in placing the muslin cover which preceded it, slip-tacking the middles first, etc. Keep the tacks near what is to become the edge of the cover that the narrow binding or guimp may cover both tack heads and raw edge of cover.

(8) Place the guimp. Start at one corner using a 4 oz. tack. Stretch it across the side to the other leg and fold the corner so as to form a square-miter, inserting a tack a little off center that it may not interfere with the placing of an upholsterer's nail later. Continue this around

the entire frame. Place the ornamental nails, Fig. 480. For the sake of looks it is necessary to have these nails

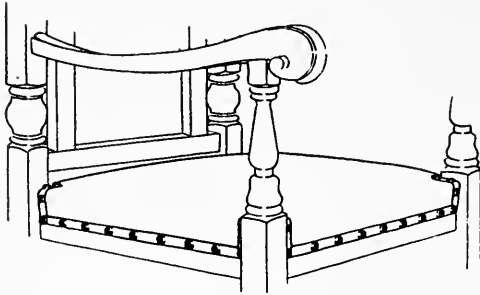

FIG. 480. ORNAMENTAL NAILS.

equally spaced. To do this place a nail midway between the corner nails; break the resulting spaces each into two parts in a similar manner. Continue in this manner until the nails are about $1\frac{1}{2}$ " apart.

As in the case of other materials, there is a rather wide range of choice in the matter of nails, ranging from solid leather heads to heads which may be covered with a material similar to that used for the top covering.

In Fig. 481 is shown a slip-seat, the method of upholstering which is somewhat like that just described.

260. Spring or Box Seat.—The spring seat furnishes a most comfortable style of seating. (1) Form a seat for the springs by cross-weaving the webbing as in Figs. 482 or 483.

Roll the ends of the webbing so that the tacks may secure a firm hold of the cloth. Use upholsterer's No. 6 tacks. In Fig. 482 fasten one end of a piece of webbing, then roll the other end, after cutting to length, so as to make it sufficiently short to cause the tacks to draw the webbing taut when driven home. Use

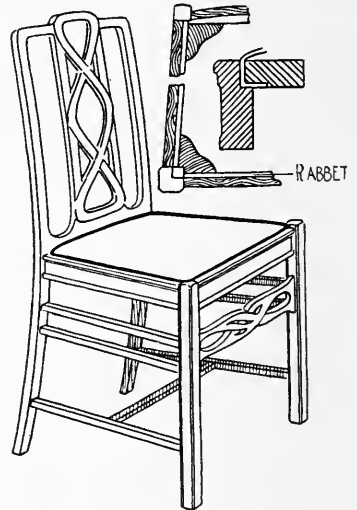

FIG. 481. SLIP-SEAT.

about 3½" webbing of good weight, and so arrange the weaving that the springs may be placed upon the lappings.

(2) Set the springs, bent ends up, on these lappings and fasten them to the webbing by means of stitching twine and an upholsterer's 6" double-pointed needle. Fig. 483.

(3) Next, tie down the springs, using spring twine. Start at one corner and work with system. The cord is not cut for each spring, but a liberal length is cut and this run and knotted

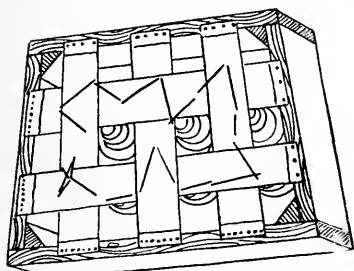

FIG. 483. SPRINGS STITCHED IN PLACE.

until exhausted, after which another piece is attached and the process continued, Fig. 484. The springs should be so tied down that the center of the seat may have a slight crown.

(4) Over the springs, several thicknesses of stout burlap are to be placed and tacked securely to the rails. The stretching of the burlap, Fig. 485, is done in the same manner as was the webbing, by rolling the final edge a little short and placing the tacks so that they will draw the material smooth as they are being driven home. Do not draw the burlap tight enough to depress the springs lower than their position as held

by the spring twine. Stitch the burlap to the springs. (5) On this burlap a piece of canvas or

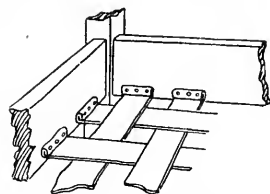

FIG. 482. BASE FOR SPRING OF BOX SEAT.

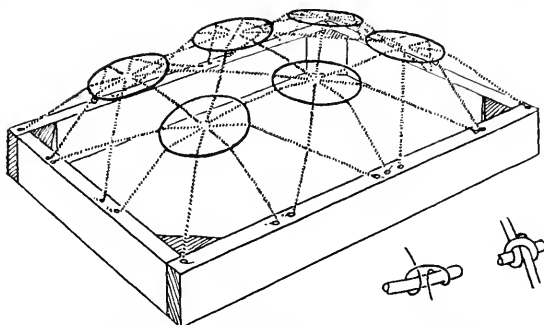

FIG. 484. SPRINGS TIED DOWN.

duck is placed, suitable filling being placed between the two to round up the seat nicely. (6) A piece of muslin or denim may be tacked to the underside of the frame to conceal the webbing, Fig. 485.

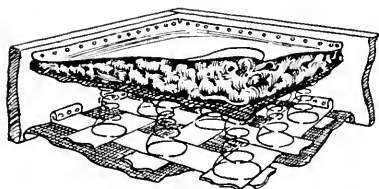

FIG. 485. SECTION OF FINISHED SEAT.

This form of seat is often placed in Morris chairs, a loose leather cushion being placed upon it.

261. Woven Reed Seat.—Another type of seating is shown in Fig. 487. This is made by cross-weaving a flat reed. This material is allowed to soak in water several hours after which it becomes pliable, and can be woven around the rails and fastened in a knot on the reverse side of the seat. With the drying of the strands the seat becomes taut. Experience alone can give the information as to the required looseness or tightness of the weave. The amount depending upon the dampness of the reed. Designs of various kinds may be worked out as shown in the illustration.

Fig. 486 shows a needle used to carry the reed in this weaving. The end of the reed is slipped thru the eye of the needle.

The flat reed sometimes used for this weaving proves brittle upon drying. This is due to the fact that it is a pith reed. A stronger seat is obtained where hickory or ash splints are used, the ends being made fast to each other on the reverse side of the stool by means of light metal clips.

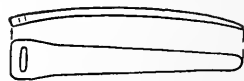

FIG. 486. NEEDLE FOR REED WEAVING.

262. Rush Fiber Seat.—Another seating made use of in manual training shops is that of the rush fiber, Fig. 488. The fibers are the leaves obtained in the fall from the familiar swamp cat-tail plant. These are allowed to

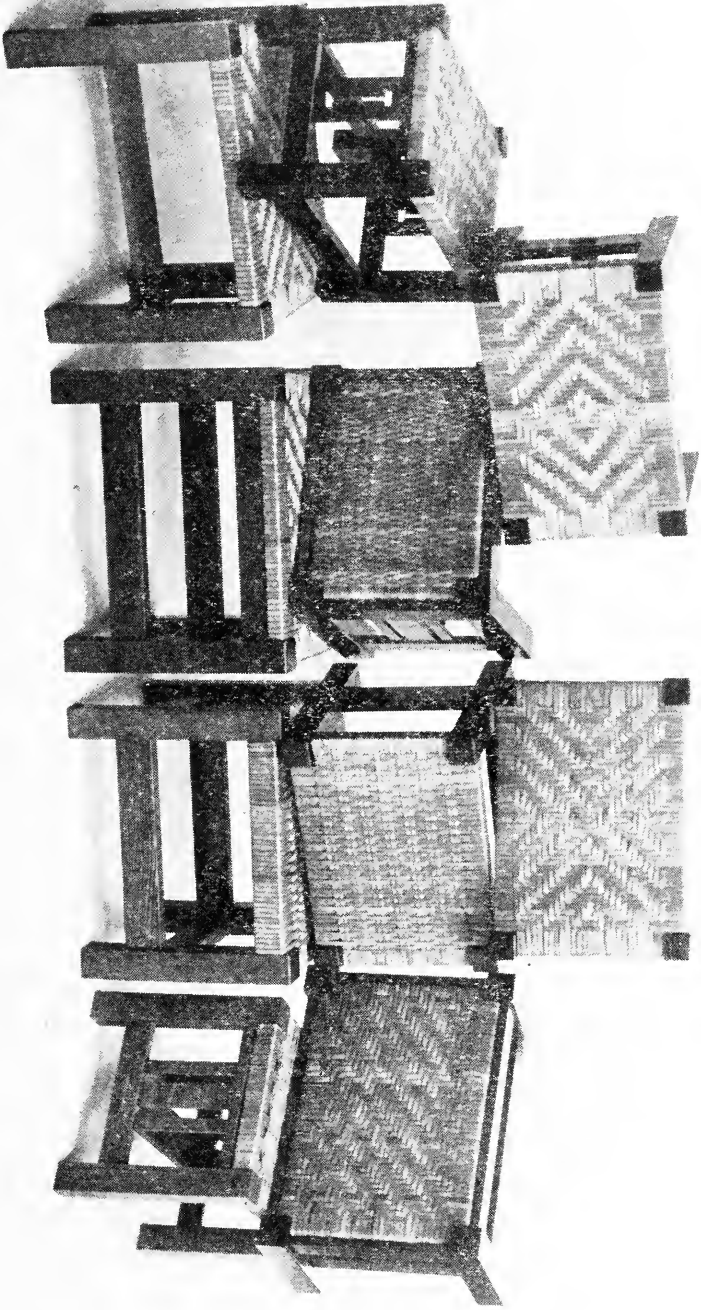

FIG. 487. REED SEATS.

season. When wanted for use they are soaked in water until quite pliable and then run thru an ordinary clothes-wringer to remove the surplus water. By wrapping these about a core of the same material a continuous

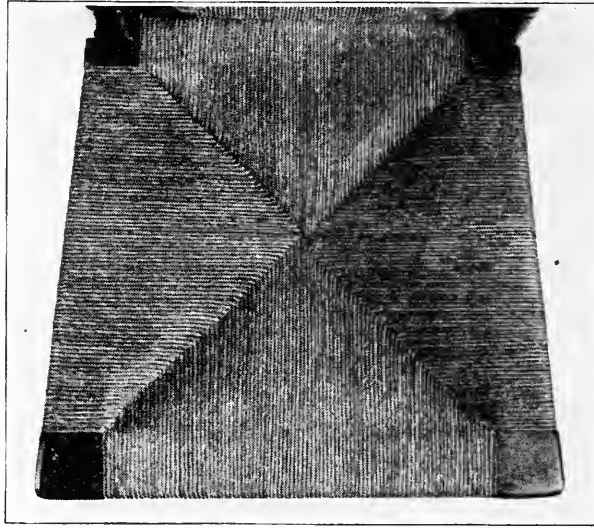

FIG. 488. FIBER SEATING.

rope is obtained which is woven about the rails of the chair or stool as rapidly as formed, Fig. 489. No small amount of skill is required to keep this rope uniform and to arrange the beginnings and endings of a wrapping rush so that they shall show on the under side of the seat only.

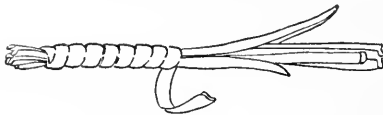

FIG. 489. FORMING THE STRAND.

(1) Begin by fastening one end of the rope as at A, Fig. 490. (2) carry the rope around the nearest rail, as at A, carrying it under, then over. (3) Now carry it around the adjacent rail, as at B, carrying it under, then over. (4) Next, carry the rope entirely across the stool to the opposite rail, passing it under, then over, as at C.

(5) Pass it around the adjacent rail, as at D. (6) Now carry it entirely across the stool to E. Continue in this manner until the center is reached, adding rushes as needed. Keep the strands pressed against each other closely and always pass the rope under from the inside, then over the rail.

When the seat is oblong the seat is woven in this manner until the equivalent of the square has been woven, after which the rest of the weaving will be about only the two rails which have not been entirely covered.

That the strands may hold their shape and not sag with use, the space between the layers should be stuffed rather firmly with cloth or paper as the work of weaving progresses.

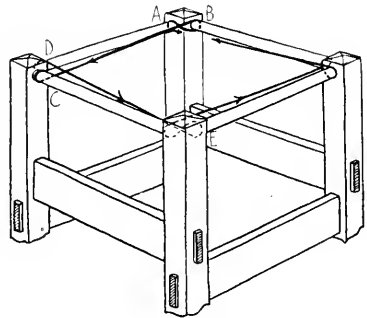

FIG. 490.

ORDER OF PROCEDURE.

A substitute fiber, more generally used upon commercial pieces, may be purchased in large spools of fine, medium, and coarse, in green and light brown colors. This material is a tough machine-twisted paper which looks and wears well.

In weaving, a strand some 10 to 15 ft. should be cut off and coiled about two-thirds of its length for convenience in handling. A rubber band about the coiled portion will be found an added convenience. Moisten slightly.

The completed seat may be finished with a thin coat of shellac and two coats of varnish. Real rush seats may be finished with oil, followed by shellac, then varnish.

263. Cane Seating—Cane seating is common. The cane is the bark of the climbing rattan palm which grows in the East Indies. The stems of these vines seldom

exceed 1" in diameter, yet they grow to the tops of the highest trees, then drop again to the ground. The material is shipped to Western countries where its bark is removed by machinery and the stem cut into various sizes

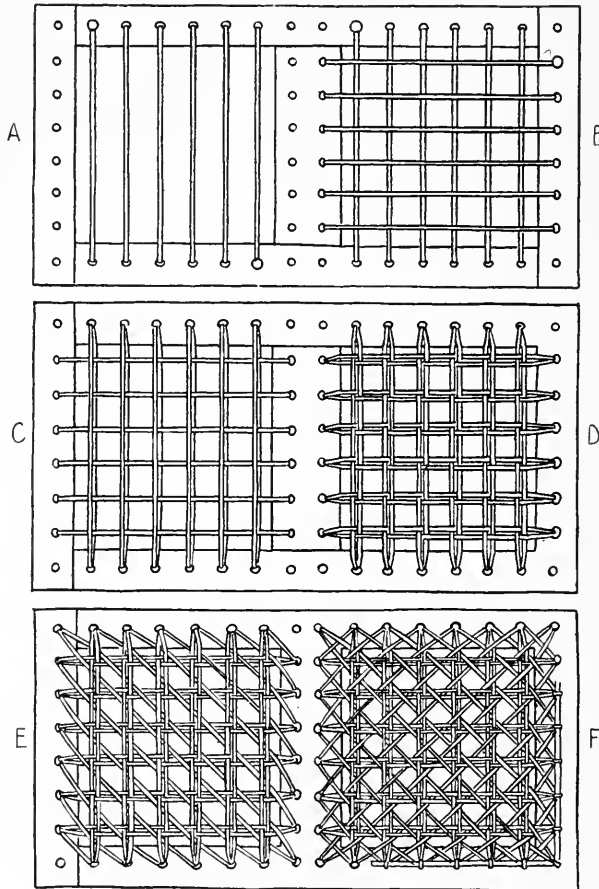

FIG. 491. WEAVES IN CANING A SEAT.

of round, oval, and flat reeds. There are about six different sizes, the medium being used for ordinary work, the fine for binder about the edges.

(1) Lay off and bore holes of $\frac{3}{16}$ " diameter $\frac{3}{4}$ " apart on coarse weave, $\frac{5}{8}$ " on medium, and $\frac{1}{2}$ " on fine, placed

$\frac{1}{2}$ " to $\frac{1}{4}$ " from the inner edge of the seat or frame to be covered, Fig. 491. (2) Dampen the strands somewhat by drawing them thru a well moistened hot cloth as they are being worked in place. The canes come in 16 ft. lengths and may be cut in two to facilitate handling. (3)

Take a strand and fasten at a corner of the seat, Fig. 491. A wood peg driven firmly into the hole will serve to hold the end in place. Prepare several of these pegs, using one of them to hold a strand until a new strand is plugged. (4) Weave as in Fig. 491. Weaves A B C should not be drawn up tight but left rather loose. Weave D will tend to tighten them and the evaporation of moisture will do the rest.

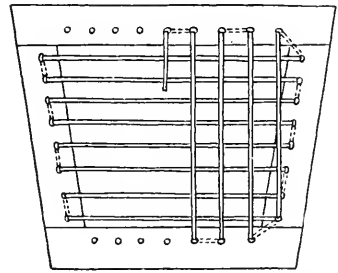

FIG. 492. ORDER OF STRANDS IN IRREGULAR FRAME.

Where a cane strand is exhausted, plan to leave enough end at the rail so that this may be caught under a following weave as it runs from hole to hole on the under side of the rail. The beginning of the first strand is similarly fastened, after which the plug may be removed.

Fig. 492 illustrates the order of the first strands where the frame is not square.

A rod such as that shown in Fig. 493 will be found helpful. It should be of a length sufficient to reach entirely across the



FIG. 493. CANING NEEDLE.

seat being woven or caned. The hooked point is manipulated in passing it thru by turning the rod over and back as required to work the point under and over the strands. After the needle has been woven thru it is threaded with cane and both drawn back to the first side.

(5) In panel E, Fig. 491, containing the first diagonal strand, it should be noted that the strand is so woven that it slips between the two cross weaves.

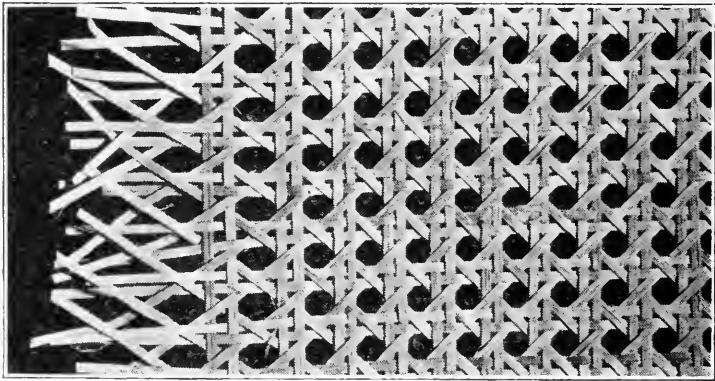

FIG. 494. COMPLETED WEAVE.

(6) The weaving of panel F is similar to that of E. Fig. 494 shows a photograph of a completed weave. (7)

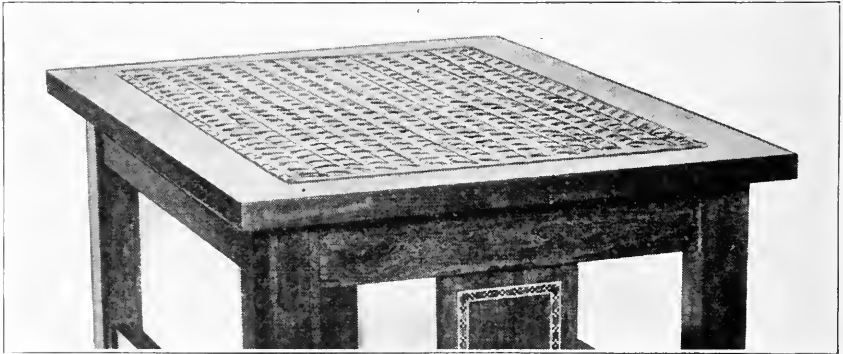

FIG. 495. COMPLETED SEAT.

A binder is usually applied to the caned panel, Fig. 495. This is done by placing a strip of fine cane lengthwise over the holes, around the seat and binding it in place

by another strand worked up thru each hole over the binder and down thru the same hole.

An awl will be needed to force the strands together where several enter the same hole and others still must be inserted.

In commercial caning splicings are made by means of light metal clips. This saves material but it is not so satisfactory as where the splicings are made at the rails. Most cane seatings of today are machine made, the caning being purchased in machine-woven rolls. The upholsterer simply cuts from this roll the size desired, moistens it by placing it between hot cloths, then places it on the seat and drives home in glue-filled grooves the fillets already prepared.

(8) The application of several coats of shellac or varnish will serve to keep moisture from affecting the cane in damp weather.

CHAPTER IX.

PATTERN-MAKING.

264. **Pattern-making.**—Pattern-making is the art and science of making forms, or models, called patterns, into whose impressions in sand, called moulds, metal is poured to give forms known as castings.

265. **Materials.**—Patterns may be made from a number of materials, such as wood, metal, plaster of Paris and molding sand. Of these, pattern-making in wood will receive chief attention in this discussion. The pattern woods most used are white pine, mahogany, baywood, cherry, walnut, chestnut and redwood. Of these white pine is considered with most favor because it works easily and holds its shape best.

266. **Flasks.**—Since patterns are made only that they may be of service to the molder, one cannot have a very clear understanding of the requirements for good patterns without a knowledge of the fundamental operations of molding.

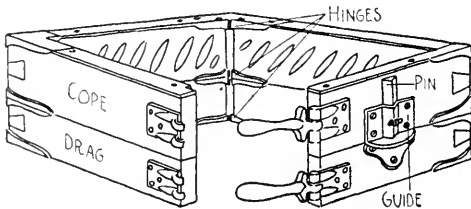

FIG. 496. SNAP FLASK.

Molding is distinguished as "floor" or "bench" according as it is done on the floor or on a bench. Fig. 496 illustrates what is known as a snap flask. This flask is used mainly in bench molding of small patterns. A flask is used to hold the sand while the mold of the pattern is being made. After the mold has been made, such a flask is set upon the

floor with its sand, and the flask removed that it may be used to hold sand for still other molds, the snap fastenings permitting its easy removal.

In Fig. 497 is shown a floor flask. This flask, like the snap flask, is divided into two parts, the top part being known as the cope or top flask, and the bottom as the drag or bottom flask. Sometimes one or more middles or cheeks are used

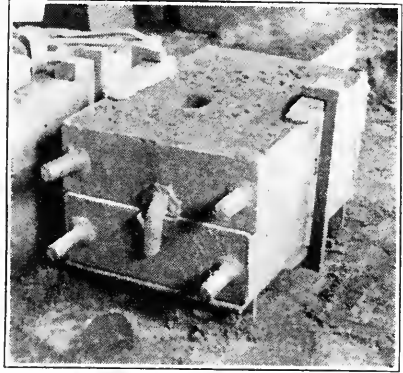

FIG. 497. FLOOR FLASK.

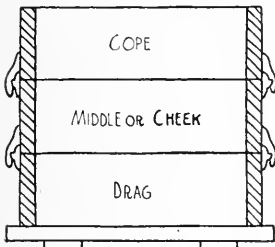

FIG. 498. THREE-PART FLASK.

when the shape of the pattern makes this necessary, Fig. 498.

267. Molding Operations.—The principal typical operations involved in molding are as follows: (1) The

drag flask is placed upside down upon a molding board or follower. (2) The pattern or drag part of the pattern is laid on the molding board, Fig. 499. (3) An amount of molding sand sufficient to cover the pattern well is riddled upon the pattern and board, after which unriddled sand is filled in, and as much as will remain

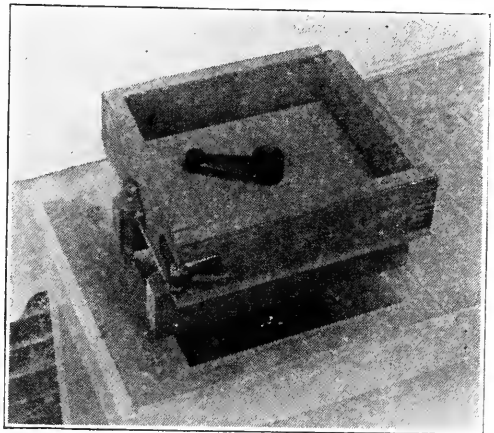

FIG. 499. PATTERN LAID ON MOLDING BOARD.

left on top. (4) The drag is rammed up and struck off, Figs. 500 and 501. (5) A bottom board is bedded on solidly and the drag flask is rolled over, Fig. 502. (6)



FIG. 500. RAMMING THE DRAG.

FIG. 501. STRIKING OFF THE
DRAG.

The molding board is now taken off and a parting made, Fig. 503. The line of parting may or may not be a straight line.

FIG. 502. ROLLING OVER DRAG
FLASK.

FIG. 503. MAKING PARTING.

Patterns may be rammed up wholly in the drag, or partly in the cope and partly in the drag. When the pattern is to be rammed up in both drag and cope, it is

frequently constructed in two parts which will separate along the line of parting. Where the pattern-maker does not construct a parted pattern, the molder will ram up



FIG. 504. PLACING PART TO BE
RAMMED UP IN THE COPE.

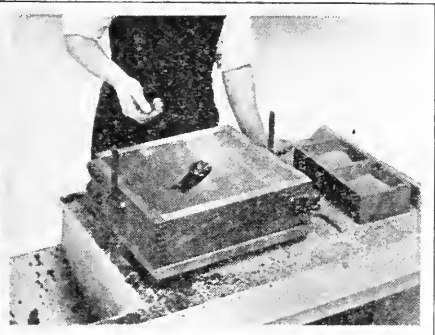

FIG. 505. SPRINKLING PARTING
SAND.

the solid pattern wholly within the drag. When the follow board has been removed after the drag has been rammed up and inverted, the molder must "cope down,"

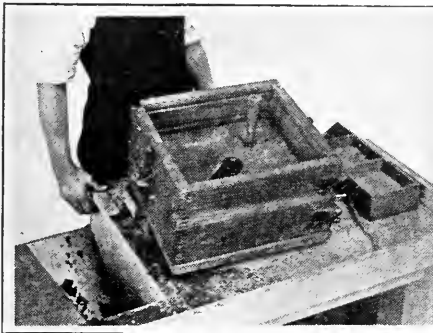

FIG. 506. COPE PLACED AND
SPRUE PIN SET.



FIG. 507. VENTING.

that is, remove the sand about the pattern, until the pattern can be withdrawn without breaking the mold. The molder will now place that part which is to be rammed up in the cope, Fig. 504. After the parting has

been properly prepared, parting sand, dry sea sand or rattler sand, is sprinkled over the parting and pattern, Fig. 505. This sand serves to keep the molding sand of the cope from adhering to that of the drag. (8) The cope is placed and the sprue pin set, Fig. 506. Sprue



FIG. 508. COPE LIFTED OFF.

FIG. 509. DRAWING PATTERN-
RAPPING.

pins are used that openings may be formed thru the cope into the drag thru which the metal may be poured. (9) Sand is riddled over pattern and parting after which the cope is filled full of sand and tamped and vented, Fig. 507. (10) The sprue pin or pins are withdrawn, and the cope lifted off and set aside, Fig. 508. (11) The pattern is



FIG. 510. CUTTING GATES.

FIG. 511. READY FOR POURING.

rapped, forced slightly in horizontal directions to release the sand from pattern's sides, and then drawn; gates are cut and cores are set if there are any, Figs. 509 and 510.

Gates are the sluiceways or channels thru which the metal flows from the base of the opening in the cope made by the removal of the sprue pin. Cores are, as the name implies, devices used to form cores or central portions of a mold. Their composition will be discussed later. (12) The cope is replaced upon the drag and either clamped or weighted, Figs. 497 and 511.

268. Determining Factors in the Construction of a Pattern.—A pattern for a given casting can, ordinarily, be

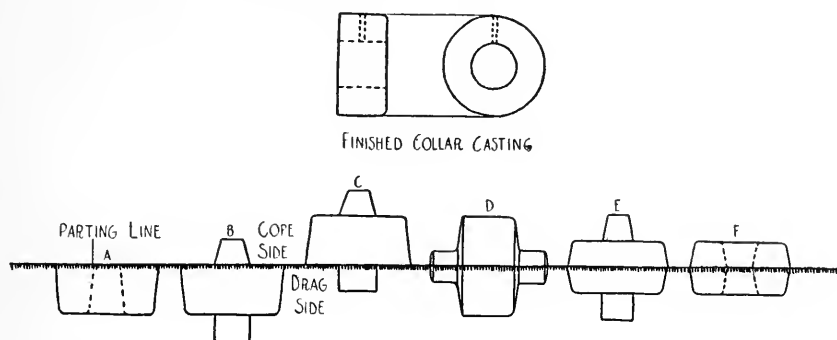

FIG. 512. VARIOUS WAYS OF CONSTRUCTING PATTERNS FOR A COLLAR.

constructed to serve its purpose in any one of a number of ways. In Fig. 512 are illustrated a number of different constructions for a pattern to produce a given casting. Among other things, the following factors must be considered, one with reference to another: the number of castings to be made, the requirements of the pattern as to permanency, economy of time on the part of the molder, economy of time and materials on the part of the pattern-maker; ease and economy of time in working the castings in the machine shop.

If but one or several castings are wanted, the economy of time on the part of the molder may give way to the economy of time or material on the part of the pattern-maker, etc.

269. Molding Sand.—Molding sand must be able to withstand great heat and contain clay or alumina enough to cause it to hold its shape after the pattern is withdrawn. A sand composed of approximately 6 per cent alumina and 90 per cent silica will possess the qualities needed when tempered with a proper amount of water. When such sand is used in making a mold, it is known as "green sand." Green sand has a yellow color when fresh, and black when burnt thru use in successive molds. Most all bench and floor molding of patterns is done in green sand.

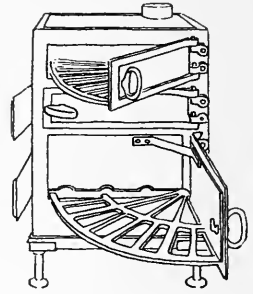

FIG. 513. CORE OVEN.

Dry sand is composed of some binder, such as flour, resin, glue water, glucose, linseed oil or molasses, and a sharp sand of almost pure silica. Dry sand is employed in the making of molds in flasks or core-boxes where greater strength than is given by green sand is required.

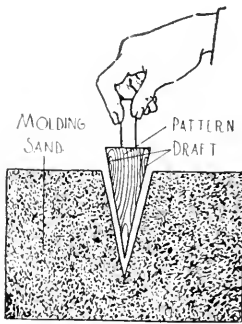

FIG. 514. EFFECT OF DRAFT.

Dry-sand cores, for example, must be handled in setting and therefore require a strength not necessary in green sand work where the sand is not handled. Such dry-sand cores are baked in an oven known as a core oven, Fig. 513.

270. Pattern Draft.—That a pattern may be drawn from the sand with as little distortion to the mold as possible, patterns are made with their vertical sides tapering. This tapered effect is known as draft, Fig. 514. The amount of draft to be allowed is the fraction of an inch which is to be added to the horizontal dimension for each foot of vertical dimension. When the edges of the pattern are

vertical and the draw is across the grain of the wood, the draft should be at least $\frac{1}{8}$ " to the foot. If the draw is with the grain, the allowance may be as low as $\frac{1}{16}$ ". An allowance of $\frac{1}{8}$ " draft per foot may be compared to the taper of a wedge 1 ft. long, $\frac{1}{8}$ " thick at the greater end and converging to a feather edge at the other end. On intricate patterns these amounts may have to be increased. The more draft the easier the work of the molder; the increased cost of metal, which is an extra, and time in machining, should there be machine work to be done, makes it advisable to give as little draft as is possible. On very light, small patterns, the amount of draft may be as little as $\frac{1}{32}$ " to the foot.

271. **Shrinkage.**—Since metals contract in changing from a molten to a solid state, allowance must be made

by the pattern-maker in constructing his patterns when of certain sizes. Fig. 515 will serve to illustrate shrinkage of metal in molds.

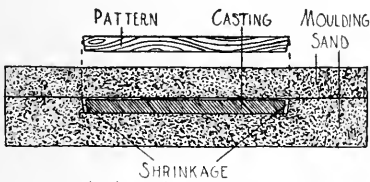

FIG. 515. SHRINKAGE OF METAL IN MOLD.

The amount of shrinkage in metals depends greatly upon the shape and size of the castings, as well as upon the kind of metal used. In pattern-making practice, the most commonly used shrinkages are as follows:

Metals	Shrinkage allowance per Foot
Aluminum	$\frac{3}{16}$ "
Brass, Bronze, Copper	$\frac{1}{8}$ to $\frac{3}{16}$ "
Grey or cast-iron, white or malleable iron	$\frac{1}{10}$ " to $\frac{1}{8}$ "
Steel	$\frac{3}{16}$ " to $\frac{1}{4}$ "
Lead	$\frac{5}{16}$ "

Care must be taken to make use of the proper shrinkage rule in the construction of the pattern, see Sec. 21.

272. **Shrinkage vs. Rappage.**—In small patterns the effects of rapping may be sufficient to overcome the effects of shrinkage. If the pattern is 6 inches or less in any one direction, shrinkage may be disregarded. If a pattern is 4 inches or less and an accurate casting is desired, not only is shrinkage disregarded but the pattern will be constructed slightly smaller than the casting required to allow for “shake” or rapping.

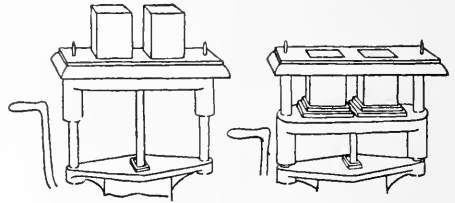

FIG. 516. MOLDING MACHINE.

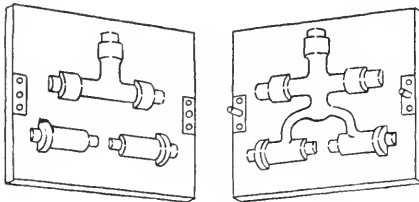

FIG. 517. MATCH PLATE.

It is possible by the use of a machine to manipulate patterns in molding so that the effects of rapping and draft are eliminated. The essential part of such machines making this possible is the stripping plate, a plate which holds the sand while the pattern is being drawn. Such machines are used only when large numbers of castings are wanted requiring accuracy, Fig. 516.

273. **Double Shrinkage.**—Machines, such as that just mentioned, have metal patterns. Metal patterns are also commonly used without machines where permanency is required. To allow for contraction in metal pattern when cast, and also in the castings made from this metal pattern, double shrinkage must be added to the first pattern. For example, if a brass pattern is to

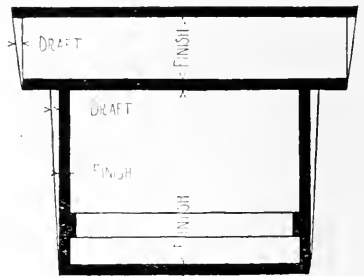

FIG. 518. ALLOWANCE FOR DRAFT AND FINISH.

be made from which to make iron castings, the first pattern will be given an allowance of $\frac{3}{16}$ " for the contraction of the brass and $\frac{1}{8}$ " for the iron, a total of $\frac{5}{16}$ ". Small



FIG. 519. FILE FINISHING.

and delicate patterns are made in metal in this manner, when many castings are desired, and placed upon a match plate—a board or plate used to hold both halves firmly while the flasks are being rammed up, Fig. 517.

274. Finish.—Not infrequently parts of castings must be machined so that they may fit together properly. Sufficient allowance must be made in the construction of the pattern that the casting may be large enough so that the tool of the

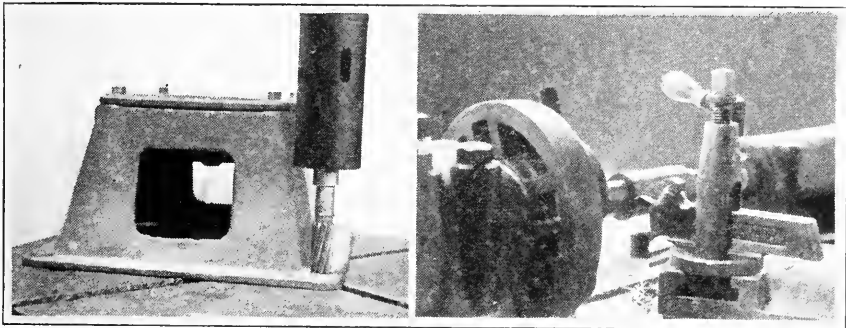

FIG. 520. SPOT FACE WORK.

FIG. 521. MACHINING.

machinist may get under the scale which is to be found upon the surface of every casting. Surfaces of castings will be found twisted, or warped, while lack of uniform tamping or ramming up will cause swells in a casting

Fig. 518 illustrates allowances for draft for the molder and allowance for finish for the machinist.

There are three kinds of finish: file, spot-face, and machine. File finish and spot-face are designated upon the drawing by the names written out in full, while machine finish is indicated by the letter "f" intersecting the line representing the surface to receive finish.

File finish, Fig. 519, requires an allowance of not over $\frac{1}{16}$ " to the surface, just enough so that a few strokes of the file may give the desired finish.

Spot-face work, Fig. 520, requires an allowance just sufficient to permit a cut beneath the hard surface scale. On iron $\frac{1}{32}$ " is sufficient, while on brass and aluminum the allowance is less.

Allowance for machine finish, Fig. 521, will vary from

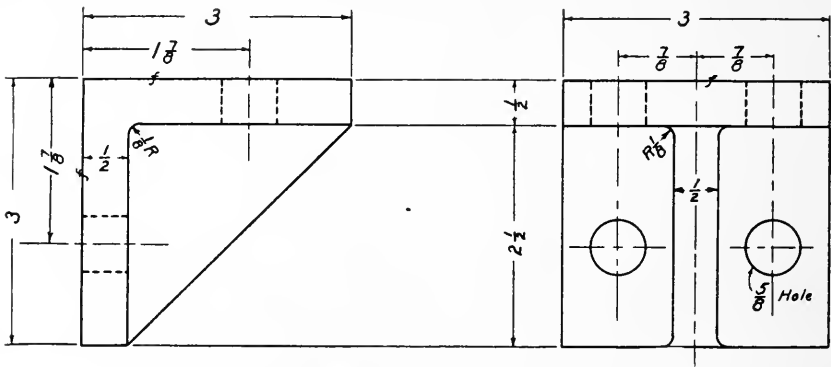

FIG. 522. MACHINIST'S DRAWING.

$\frac{1}{32}$ ", on small brass castings, to $\frac{3}{4}$ " on large steel castings, such as engine beds. The allowance most generally made is $\frac{1}{16}$ " on brass and aluminum and $\frac{1}{8}$ " on iron, with $\frac{1}{4}$ " to $\frac{3}{4}$ " on steel.

275. Making a Lay-Out.—A lay-out or pattern drawing consists of a sectional view of a pattern drawn on paper or a soft pine board. This drawing should be made

actual or full size, the dimensioned machinist's drawing, Fig. 522, providing the data, allowances for draft, finish, etc., being taken into consideration. Since paper varies in damp and in dry weather, the lay-outs made upon paper should have all necessary dimensions placed thereon, Fig. 523. Lay-outs should be carefully made, for reference will be made to them constantly as the work progresses.

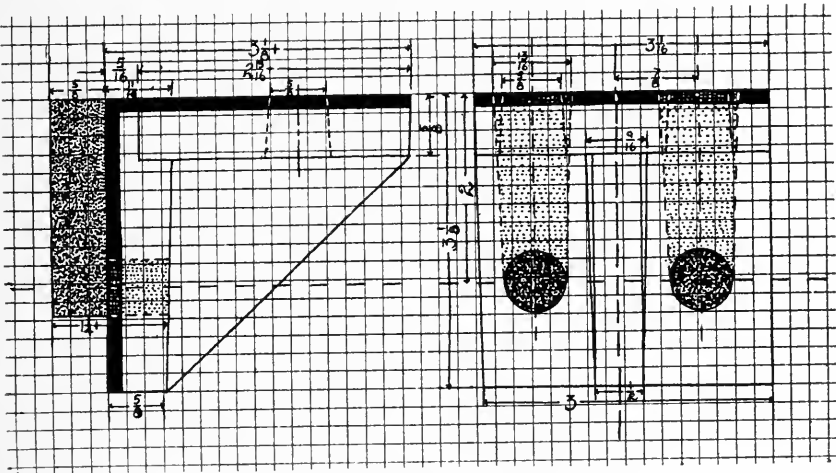

FIG. 523. PATTERN-MAKER'S LAY-OUT OR DRAWING.

A board to be used for a lay-out should have a face and an edge planed true. In making a lay-out on a board, Fig. 524, the try-square, or framing square, the dividers, the marking gage, and knife take the place of triangles, T-square, compass and pencil used in making a lay-out on paper. The shrink rule is used in either case.

On the board lay-out, the try-square and knife are used in scoring lines across the grain of the wood and the gage for lines along the grain. The board should show the general construction of the pattern, the draft, the finish, the cores, and the core-prints of the pattern, as it

requires these. No dimension lines are required, the dimensions for the pattern being taken directly from the board.

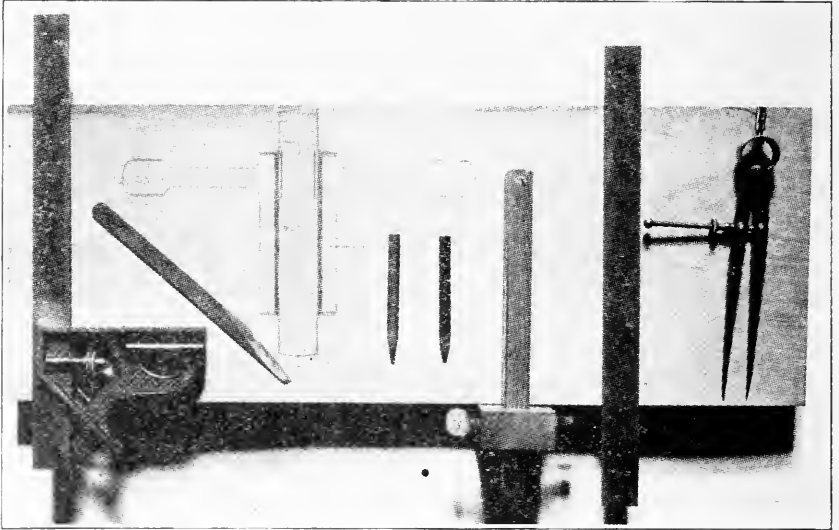

FIG. 524. LAY-OUT BOARD.

After the lay-out has been set out, "allowance" may be colored with a red pencil; the part representing the cores and core-prints may be outlined with a blue pencil; and the various knife and gage lines may be gone over with a sharp-pointed 2H pencil to make them easily visible. The whole board may be given a coat of orange shellac to keep the lay-out clean and lasting.

276. Order of Procedure.—A pattern-maker usually makes use of the following order of procedure: (1) The machine drawing, Fig. 522, is carefully studied until understood; (2) the lay-out is made on paper or on wood, Figs. 523 or 524; (3) stock required for the pattern is figured; (4) the pattern is constructed; (5) stock for the core-box is figured; (6) the core-box is constructed; (7)

all work is checked up or measured to see that it meets requirements set by the machine drawing.

277. Fillets.—All arrises and shoulders of a pattern should be rounded when there is nothing in the design to interfere seriously. Sharp corners in a pattern are a source of trouble to the molder when he attempts to draw the pattern from the sand. Not only do they make a poor appearing casting but, due to the way in which the molecules of metal adjust themselves with reference to the surfaces, they make a weaker casting. The

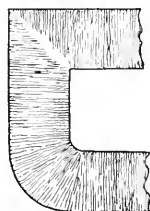

FIG. 525. EFFECTS OF SQUARE AND ROUNDED CORNERS.

light portion of the drawing in Fig. 525 represents the weakened portion, the lines of strength tending to arrange themselves at right angles to the surfaces of the casting. Fig. 525 also shows a shoulder filleted and an arris rounded. These operations are seldom performed until the pattern is about ready to

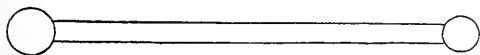

FIG. 526. FILLET STICK.

be sandpapered and shellaced.

Fillets may be made of wax, wood, leather, or any other material which may be shaped into the desired round, and retain that shape so long as the pattern is needed. Fillets made from beeswax are used in rounding shoulders of cheap patterns, and those which require a small radius. These fillets are laid in the shoulder by means of metal fillet sticks which have been heated, Fig. 526.



FIG. 527. WOOD FILLET.

On long, straight patterns, wood fillets, Fig. 527, are often used. When such fillets are bought in the form of

stock fillets already formed, the finned edges tend to curl over when glue is applied and an attempt made to nail the fillet. Strips of wood should be tacked over these edges to hold them down until the glue has had time to set, Fig. 528.

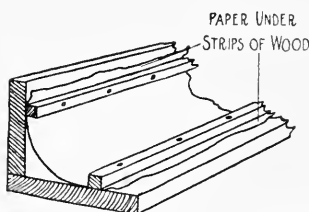

FIG. 528. WOOD FILLET PLACED.

Leather is by far the best material out of which to make fillets. It is somewhat more expensive as to first cost but is more

durable and much easier to work than other materials. Being flexible, it may be applied to straight or irregular

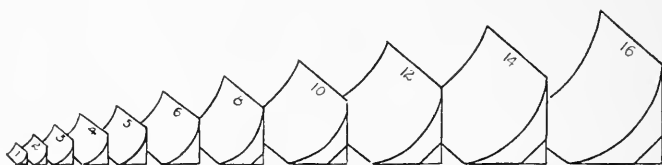

FIG. 529. LEATHER FILLETS.

surfaces, and across the grain as well as along the grain without fear of trouble thru unequal shrinkage of the pattern. Leather fillets, like wood fillets, may be purchased in stock form of various sizes, Fig. 529. In applying such fillets, Fig. 530, stretch the leather upon a board upside down and apply glue, after which quickly place the fillet and rub it into the shoulder by means of a fillet stick. If a metal stick is not available a wood one may be made from a piece of dowel stock. With a cloth dipped in warm water, immediately wipe

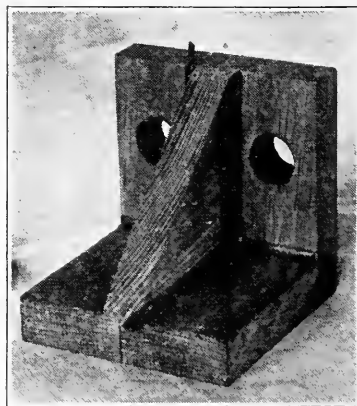

FIG. 530. LEATHER FILLET APPLIED.

away any surplus glue which may have been pressed upon the surface. Sometimes shellac is applied to the fillet and

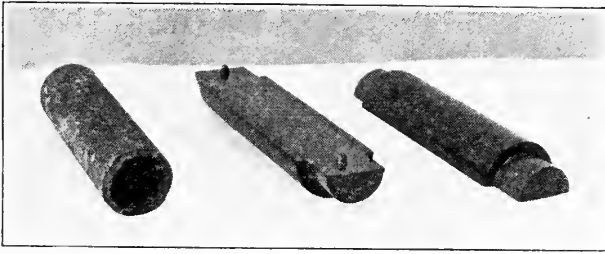

FIG. 531. PATTERN AND CASTING OF PIPE.

to the corner or shoulder instead of glue.

278. Cores; Core-Prints; Core-Boxes.—When, in

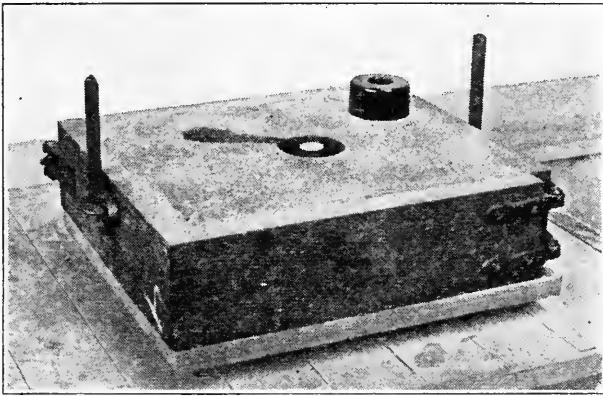

FIG. 532. VERTICAL GREEN-SAND CORE.

foundry molding, it is desired to form a casting with a hollow, or hollows therein, internal molds or cores must be used, Fig. 531. While many cores are made from green sand, most cores are made of dry sand. Green-sand cores are used wherever possible because of economy of time in making. Quite often whole molds are

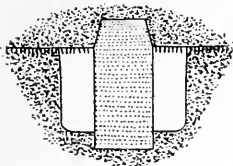

FIG. 533. VERTICAL GREEN-SAND CORE.

made in core or dry sand. Among the various types of cores are the vertical green-sand, Fig. 532, and the skeleton, each made from green sand. There are also

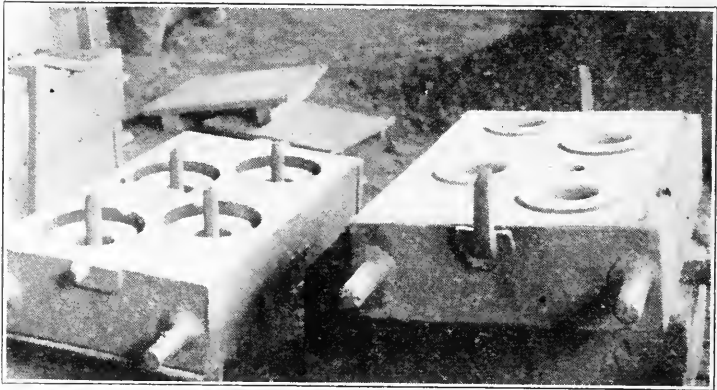

FIG. 534. VERTICAL DRY-SAND CORES.

cores made in dry sand known as vertical, Figs. 533 and 534, horizontal, Fig. 535, jacket and chest cores.

Core-prints are the projecting pieces on a pattern, Fig. 512, which serve no other purpose than to make or form impressions in the green sand into which the ends of the cores may be placed, giving and sustaining the cores in their proper position relative to the rest of the mold.

Core-boxes are divisible boxes, Fig. 536, in which sand is rammed or tamped to form cores for use in molding.

While most all core-boxes are made double, or in two parts, Fig. 537, some are made in half boxes only. This is especially true where the box is complicated in its construction, Fig. 538. When large cores are to be made, the extra time required of the pattern-maker as compared to that required of the core-

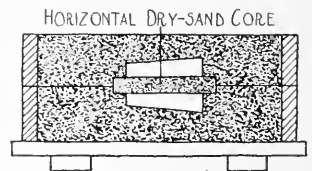

FIG. 535. HORIZONTAL DRY-SAND CORE.

maker in pasting two parts together will often determine whether a box is to be made of one or two halves.

279. Vertical Cores and Core-Prints.—Vertical cores



FIG. 536. CORE-BOX IN USE.

are such as rest in a vertical position when in the mold.

For economy of time and material core-print forms should be standardized as to draft, etc. Figs. 539 and 540 represent graphically such an effort. For all vertical prints the taper of the cope

prints is to be $13\frac{1}{2}^\circ$ or $\frac{3}{4}''$ to $3''$, and the drag prints $1\frac{1}{2}^\circ$ or $\frac{1}{16}''$ to $3''$. For all prints of $1\frac{1}{2}''$ diameter and under, the height and small diameter of the cope print should be equal to $\frac{11}{16}$ times the diameter of the core. The depth of the drag print should be equal to $\frac{3}{4}$ times the diameter of the core. For vertical prints larger than $1\frac{1}{2}''$ in diameter the length of cope print may be $1''$ and of the drag print $1\frac{1}{8}''$. The diameter of the cope print at the small end may be $\frac{1}{2}''$ less than the diameter of the core,

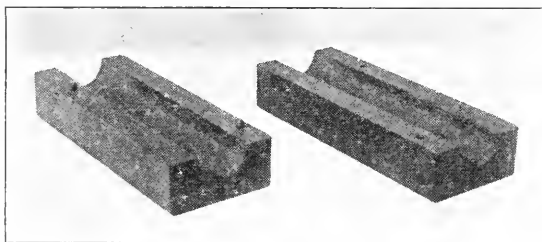

FIG. 537. TWO-PART CORE-BOX.

and the larger diameter of the drag print will be slightly less than $\frac{1}{16}''$ greater than that of the core.

The cope print is made so that it can be readily

detached from the pattern, which is done when the pattern is being rammed up in the drag. When the drag is inverted and the follow board removed, the cope print is placed. From this it will be seen that the cope print is rammed up wholly in the cope, hence its name, and also the explanation for the unusual taper given it as compared to that given the drag print.

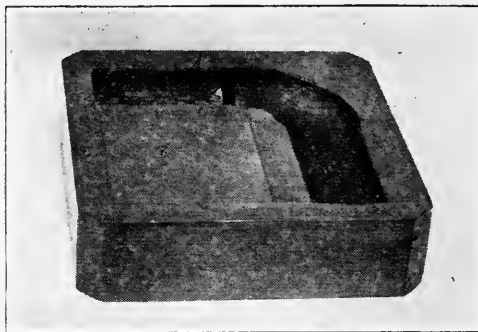

FIG. 538. ONE-PART CORE-BOX.

280. Horizontal Cores.—Horizontal cores are such as assume a horizontal position in the mold. The most common of these are the straight, the balanced, and the stop-off.

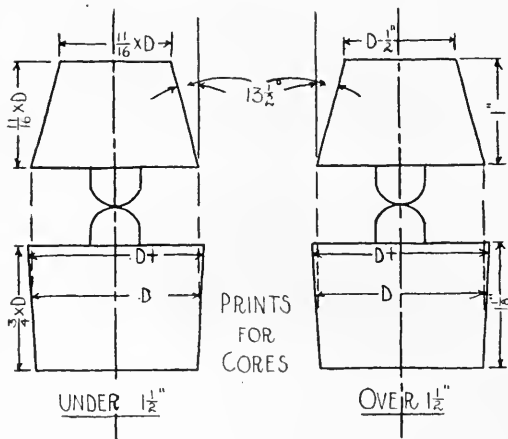

FIG. 539. CORE-PRINT DETAIL.

A simple horizontal core, Fig. 535, has its ends supported on the opposite sides of the mold. Horizontal core-prints should be made long enough to give the core a solid bearing in the mold. They should be as long as their diameter when over $\frac{3}{4}$ " in diameter, and $\frac{3}{4}$ " long

when the diameter is less than this amount. To save material, pattern-makers sometimes decrease the length of the core-print when the diameter is greater than 6"

Since the molding sand beneath the core is liable to distortion under the weight of the core, causing damage to the mold thru floating sand, a small fillet is turned at the junction of print and pattern, Fig. 541.

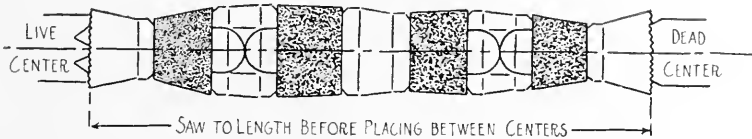

FIG. 540. METHOD OF TURNING CORE-PRINTS.

281. **Balanced Cores.**—A balanced core is a horizontal core which is supported at one end only. The print should be constructed so that the part of the core which fills its place in the mold shall be longer and heavier than that part of the core which is unsupported, Fig. 542.

282. **Stop-Off Cores.**—A stop-off core, Figs. 543 and 544, or heel core, is a horizontal core with a stop-off or

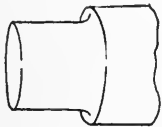

FIG. 541. FILLETED PRINT AND PATTERN.

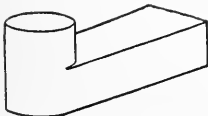

FIG. 543. STOP-OFF CORE.

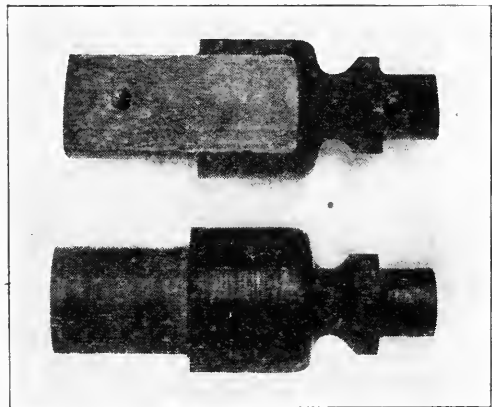

FIG. 542. BALANCED CORE.

heel print which makes the parting in molding simpler. Originally, straight, horizontal cores were laid into the impressions made by the stop-off prints and the remaining space "stopped over" or tightly filled in with molding

sand. Special stop-off cores make this latter operation unnecessary. The prints are made as thick as the diameter

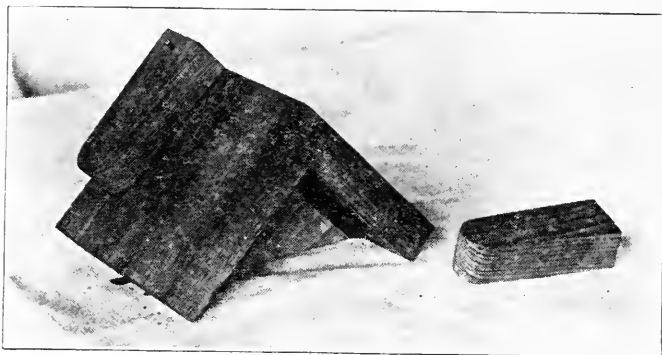

FIG. 544. STOP-OFF CORE-PRINT.

of the core. The sides of the prints are drafted just double the amount given drag vertical prints, for if the top or cope of the print were to be driven off center a little, back draft would occur and it would be difficult to draw the pattern from the mold.

283. Stop-Off Core-Box.

—To make a stop-off core-box, (1) plan the construction so that the box for the hole shall be attached to the box for the print, Figs. 545 and 546.

(2) Part the whole box thru the center of the core and along one arris of the cope parting of the print.

(3) Plane the faces of the parting true. (4) Dowel

the thinner part of the box to the thicker. (5) Scribe knife lines lightly square across each face of the parting.

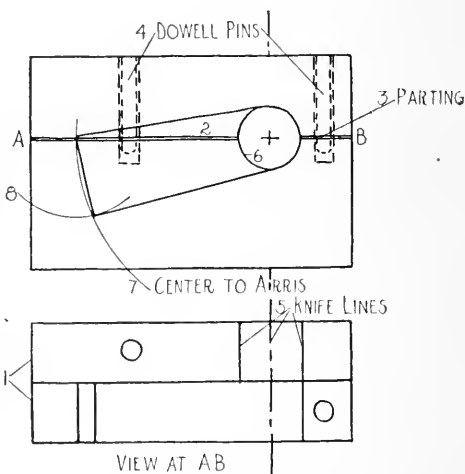

FIG. 545. STOP-OFF CORE-BOX DETAIL.

- (6) Around the center point, on the faces of each piece, describe an arc with a diameter equal to that of the core.
- (7) With a radius equal to the distance between the

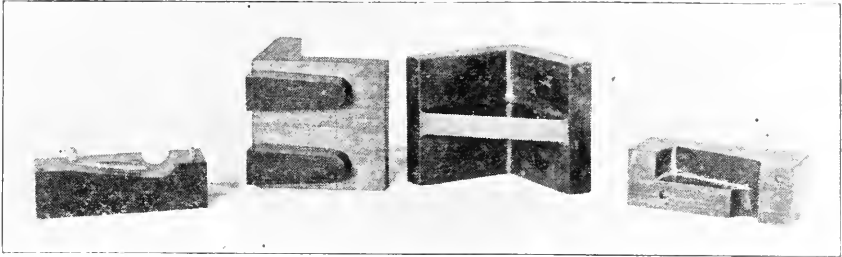

FIG. 546. PATTERN AND STOP-OFF CORE-BOX.

center of the core and an arris of the print, describe an arc upon one outer face of the box. (8) With one point of the dividers at the intersection of 7, Fig. 545, with the joint, describe an arc with a radius equal to that of the core-print, from arris to arris. The construction of the box should be evident from a study of the drawing.

284. Wood Face-Plates.—Wood face-plates are prepared upon which pattern work may be builded and, after

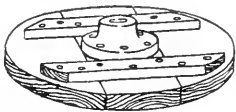

FIG. 547. WOOD FACE-PLATE.

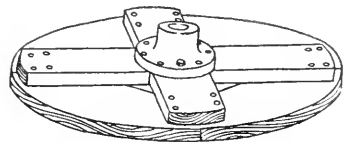

FIG. 548. WOOD FACE-PLATE FOR LARGE WORK.

the glue has hardened, turned to required form. Fig. 547 illustrates a style of face-plate for work under 20 inches in diameter. It is built of strips of wood laid edge to edge and secured by cleats across the back. This form is attached to the lathe face-plate by means of screws. Screws of both cleats and face-plate should be sufficiently short to permit the wood face-plate to be "faced off" several times without danger to the turning tool. For

large work a face-plate similar to that of Fig. 548 is prepared. The metal face-plate is fastened by screws to a couple of arms. After these have been balanced so that they will not shake the lathe in revolving, and have been faced, segments are glued and then screwed to them. Care must be exercised in facing the ends of the arms that the tool may not be caught. The arms should be at least an inch shorter than the outside diameter of the segments. After this part is completed the segments may be further strengthened by the addition of triangular pieces glued on the arms and between the segments.

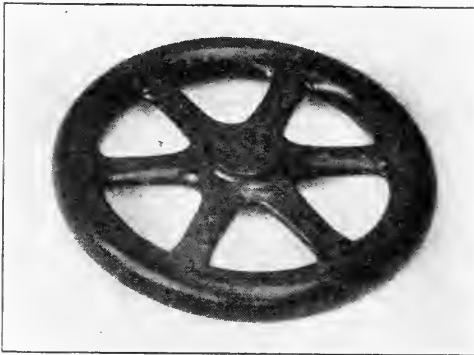

FIG. 549. HANDWHEEL PATTERN OF SOLID STOCK.



FIG. 550a. SEGMENTAL WORK.

285. Segments.—For temporary use circular patterns are turned or sawed from solid stock, Fig. 549. Where strength is required such patterns should be built up of segments or cants, Figs. 550-a, b, and c. Owing to shrinkage of wood across the grain and not along the grain to any appreciable extent, solid circular patterns of any size will not remain circular. Segmental patterns with parts laid up as are bricks in a wall, one segment

overlapping another, etc., give both strength and permanency of form.

One segment is laid off and sawed out and this used

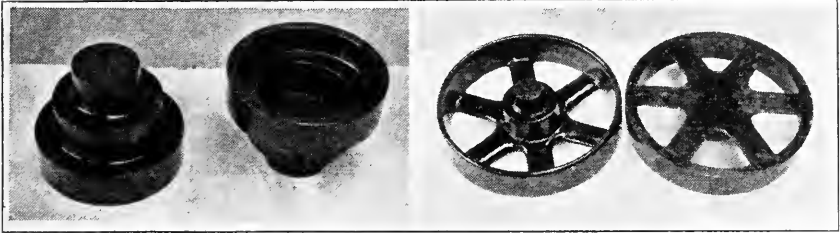

FIG. 550b. SEGMENTAL WORK.

FIG. 550c. SEGMENTAL WORK.

as a templet for laying out the remainder, Fig. 551. Where many segments are required, time is saved by stacking a number of blocks which have been cut to length, toe-nailing them and sawing the outline of the segment on top. Trim the joints to fit tightly, or trouble will be experienced in turning. 60° to 90° segments are the ones most often used.



FIG. 551. LAYING OUT SEGMENTS.

286. Lap Joint for Six-Arm Pattern.—(1) Plane the stock for the three members of the joint to dimensions as to width and thickness. (2) Gage on each edge of each piece lines which shall divide the thickness into three equal spaces. (3) Square light knife lines around the middle of each piece, and (4) with a radius equal to half

the width of the piece describe a circle upon the two faces of each member as in Fig. 552. (5) With a combination square set to 60° , knife four lines tangent to the

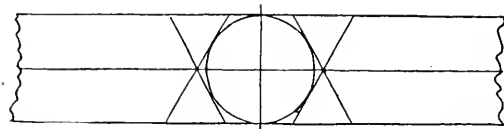

FIG. 552. LAYING OUT JOINT FOR SIX-ARM PATTERN.

circle just drawn on the faces, Fig. 552.

(6) With the aid of Figs. 553 and 554

“cross check” or “well mark” the part

to be cut out in each member. (6) Score light lines across the edges to correspond.

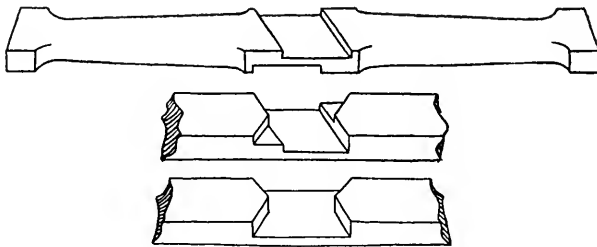

FIG. 553. PERSPECTIVE OF PARTS TO JOINT OF SIX-ARM PATTERN.

287. Laying Out Arms.—A templet, Fig. 555, of a set of two arms should be made before the joint is begun that no mistake in dimensions may occur. The templet may be made of board-paper. (1) Draw a long line for a center line of the arm. (2) Thru a center point on this line, Fig. 555, c, draw two lines forming an angle of 30° to the center line. (3) Lay out the remainder of the templet as shown, consulting the machine drawing.

The distance between the points of intersection of the 30° lines with the arcs between the arms determines the width of each member of the joint, *w* of Fig. 555.

288. Forming Arms.—After the joint has been fitted properly, neither loose nor tight, take it apart and stack the members with their edges and center lines together.

Fasten these together by brads, Fig. 556, having the outline of the form drawn upon the top member. Saw

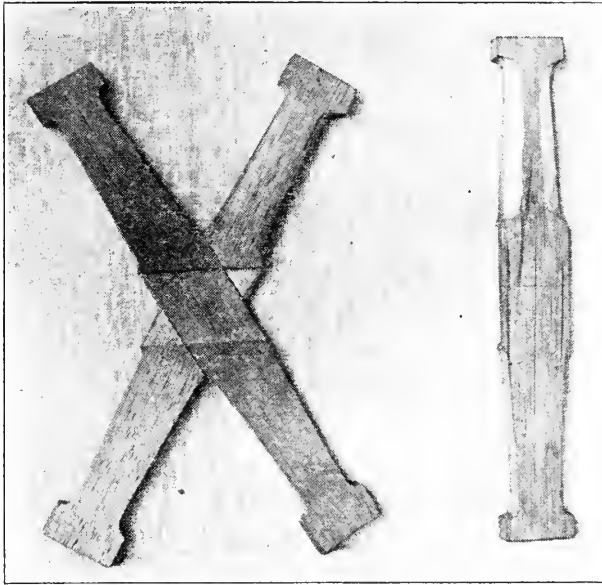

FIG. 554. JOINT OF SIX-ARM PATTERN PARTLY ASSEMBLED.

out upon the band-saw and smooth the edges where needed.

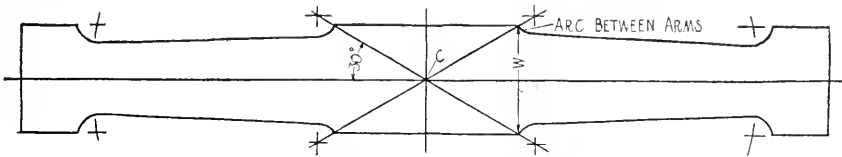

FIG. 555. TEMPLER FOR SIX-ARM PATTERN.

To give to the cross-section of an arm the shape of an ellipse, the carpenter's method of laying out an octagonal

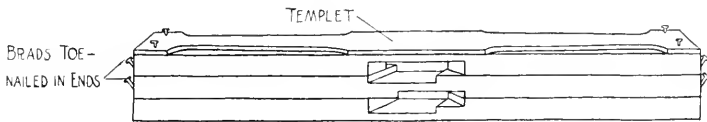

FIG. 556. MEMBERS OF SIX-ARM PATTERN STACKED—READY FOR SAWING.

prism from which to get a cylinder suggests a method sufficiently accurate for practical purposes. To lay off an octagonal prism a carpenter lays the blade of the square across with extremities resting on the two arrises

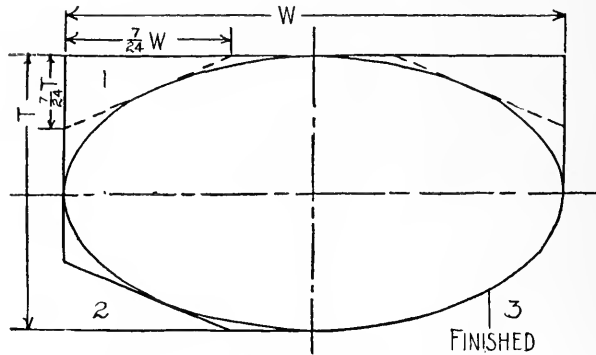

FIG. 557. LAY-OUT AND ELLIPSE.

of the stock. This gives 24", of course. While in this position he marks at the 7" and the 17" graduations. Gage settings at these marks indicate the amount of chamfer to be given to form the octagon from the square. With the octagon prism formed he can readily form a prism of double the number of sides without further guide-lines.

An ellipse is a fore-shortened circle. Applying this principle to the rectangular spoke or arm as indicated in Fig. 557, an ellipse can be formed sufficiently accurate for practical purposes. On the edge, the gage setting will be $\frac{7}{24}$ of the thickness;

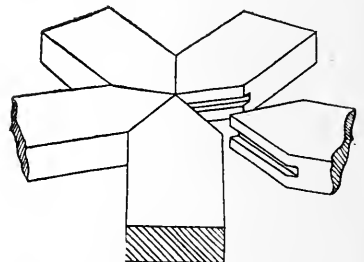

FIG. 558. JOINT OF FIVE-SPOKE SPIDER.

on the broad surface it will be $\frac{7}{24}$ of the width. After laying out these lines put on the chamfer and then finish the ellipse by increasing the number of chamfers until the sandpaper may be expected to complete the work.

Fig. 558 illustrates a different type of joint used in forming a five-spoked spider. One end of each member is cut to an angle of 72° to form a butt joint after which a spline may be made use of, if required, to give the necessary strength. If the key or spline is properly proportioned and set in glue this makes a strong joint.

289. Spur Gear Teeth.—Six methods of attaching spur gear teeth to a gear pattern are illustrated in Fig. 559. (1) The tooth is cut out of a solid block after the whole gear pattern is laid out. This method is the one used where the gear pattern is small and has no spokes or web. The grain of the block should extend in the direction of the length of the tooth. (2) Teeth are cut out of blocks

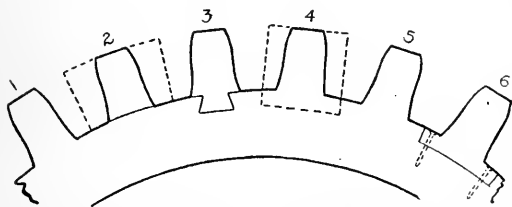

FIG. 559. METHODS OF ATTACHING SPUR GEAR TEETH.

which have been glued to the rim. In this case the pattern is usually large and has a web. The rim of the pattern should be faced, or turned, to the diameter desired at the root of

the tooth. These blocks should have their grain extending in the direction of the tooth, across the rim, and should be faced off in the lathe to the width of the rim and to the over-all dimension or diameter, before the gear is laid out. (3) Teeth are cut from blocks which have been attached to the rim by means of slightly tapered dovetails. These blocks, which should be turned to length and thickness before the teeth are laid out, are removed from the rim, shaped and then replaced. (4) Teeth are cut from blocks which have been set in and glued to the rim. (5 and 6.) Teeth are cut from blocks by shaping them in a jig, Fig. 560, after which they are fastened to the rim. Equally spaced knife lines should

be carefully laid out across the rim so that each tooth may be correctly placed. In the latter case thin strips are prepared to go between the teeth. Such gear tooth jigs are made of hard wood. A slot, slightly longer than the length of tooth, is cut in the top and has thru its bottom a screw hole at the approximate middle. Two sharp brads projecting from the center line at the bottom of the opening serve to hold the blank tooth in place once the screw has been inserted into the blank thru the jig.

There are a number of different ways of laying out gear tooth forms, such as that shown on the jig. For practical purposes the



FIG. 560. JIG FOR SHAPING SPUR GEAR TEETH.

Willis or Grant odontographs, which carry their own directions for use, will be found sufficiently accurate.

With such jigs the blank tooth may be inserted in the opening and formed by means of the edged tools to correspond to the outline of the jig, as respects the shaping of the tooth. The sandpaper cylinder of the lathe, Fig. 561, may be used to finish the tooth.

290. Bevel Gears.—Since all lines of bevel gears are elements of cones, the teeth are more difficult to cut than the spur gear. Bevel gear teeth may be made separately in jigs similar to those described above. In this case the tooth will be beveled.

Only on large gear wheels is trouble taken to cast

teeth. Small gears are cast in blanks, Fig. 562, and the teeth machined.

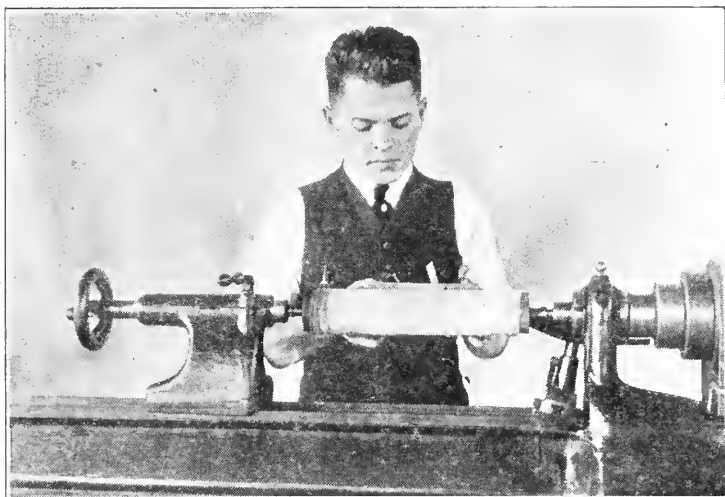

FIG. 561. SANDPAPERING GEAR TEETH ON LATHE.

291. **Split Patterns; Dowels.**—For the convenience of the molder many patterns are split, or parted, in such

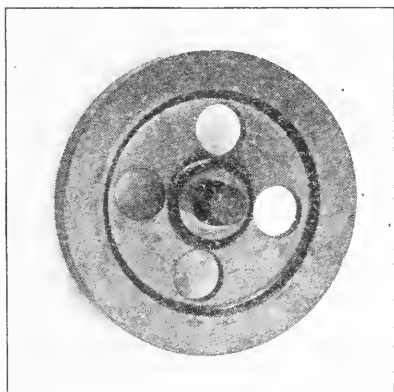

FIG. 562. GEAR BLANK PATTERN.

a way as to make it easy to withdraw them from the mold. The two parts are jointed together and doweled. The dowel-pins are used to center split patterns and core-boxes. They may be made by sawing long, square strips from some comparatively hard wood, as maple, planing off the arrises until

the stick becomes octagonal, then driving these thru a dowel-pin plate. They may be made on a lathe by the

use of a dowel shaper. Most shops carry in stock wood and brass doweling. Brass dowels, Fig. 563, are more durable than wood pins and permit a more accurate centering of the parts. Wood pins are more practical for school shop use. The shaping of the projecting end of a dowel pin and the manner of placing is one of the first things to distinguish the mechanic from the amateur. Dowel-pins should be set in such a manner that there can be no doubt for a moment in the mind of the molder as to the way the separated parts are to go together. To accomplish this, dowel-pins are set at unequal distances from the ends of the pattern.

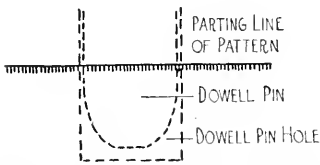

FIG. 564. WOOD DOWEL-PIN.

Ends of dowel-pins should not show on the outside of patterns, while on core-prints it does not matter. Dowel-pins should be set in the cope part of the pattern and have a projecting portion of not less than the diameter of the pin to insert into and center the drag part, Fig. 564.

292. **Turning Split Patterns.**—If a split pattern is to be turned between centers it must be made safe so that

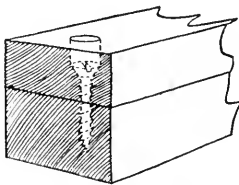

FIG. 565. PARTS FASTENED BY SCREWS.



FIG. 566. CORRUGATED FASTENERS.

it shall not fly apart in motion. The stock should be long enough, $\frac{3}{4}$ " at least, so that screws may be inserted, Fig.



FIG. 563. BRASS DOWEL.

565. Four corrugated fasteners, Fig. 566, are best for holding small split patterns while turning.

293. **Tee-Pipe Fittings.**—Tee-pipe fittings, Fig. 567, which have a main body and a branch, are made as split patterns and turned from two pieces of stock which have been jointed and doweled together. After the stock is

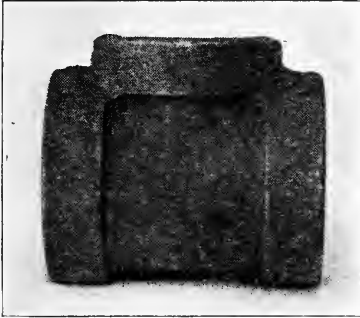

FIG. 567. TEE-PIPE FITTING.

turned to dimensions, a center line is drawn around the main body. Cut away the surplus stock and lightly knife the center lines across the parting surfaces.

The pattern may be constructed by mitering the two members together, Fig. 568, or by coping the branch to the main member or body.

To miter the two members together, (1) scribe the center line upon the butt of the branch; (2) saw off the two corners; (3) smooth these two surfaces so that they shall be at right angles, one to the other, and symmetric-

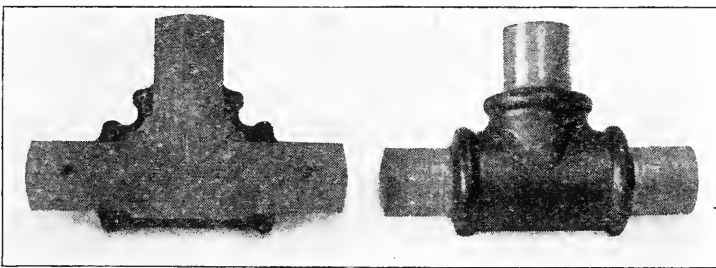

FIG. 568. MITERED MEMBERS OF PATTERN FOR TEE-PIPE FITTING.

ally placed with reference to the center-line or axis of the branch. (4) Saw out the stock from the main member and smooth its surfaces so that the branch may fit snugly.

Any size of branch may be fitted to any body of pattern when the body of the pattern is of the same size as the branch, or larger, by the use of the coped joint. To make the joint stronger a dovetailed piece is often inlaid as shown in Fig. 569.

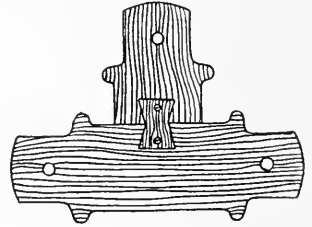

FIG. 569. COPED JOINT DETAILED.

In coping such joints, the miters will be cut on the end of the branch, the intersecting line of miter and curved surface giving the line for coping. After this the branch may be clamped to a block as shown in Fig. 570 and the waste stock cut out on the band-saw. The main body should be blue chalked

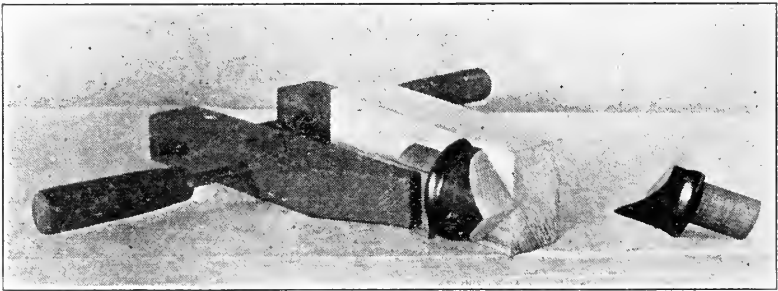

FIG. 570. COPING A MEMBER OF TEE-PIPE PATTERN.

where the joint is to come and the two members rubbed together with the partings resting upon a true metal or wood surface plate. The marks upon the branch will clearly show where the joint needs trimming to make it fit properly.

The core-box for the 90° tee-pipe is simply constructed by joining two straight core-boxes at right angles to each other, Fig. 571, and should be

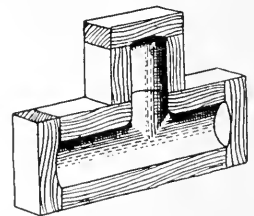

FIG. 571. CORE-BOX FOR TEE-PIPE FITTING.

strengthened by gluing and nailing a board to its back.

294. **Elbow Offset; Return Bend.**—(1) Plane true one surface of a block which has been cut at least $\frac{1}{2}$ "



FIG. 572. TEMPLAT FOR CONVEX TURNING.

larger than the required diameter. (2) Saw off the square corners. (3) Center and affix the face-plate to the true surface with a thin piece of wood of even thickness between them for backing.

(5) After screwing the face-plate to the lathe, turn roughly to the largest possible diameter. (6) Turn accurately to the thickness of one-half the pattern. (7) Cut the inside and the outside diameters to accurate dimensions. (8) Test for curvature by means of a templet cut out of a thin piece of wood, Fig. 572.



FIG. 573. MEMBERS FOR RETURN BEND PIPE FITTING PATTERN.

(9) Cut and fit the piece until a true semicircular cross-section is formed. (10) After the face-plate has been taken off the lathe, remove it from this ring. (11) With

a center head of the combination square, Fig. 40, lay off on the joint of the ring as many pieces as may be required and saw in a miter-box or on the band-saw table. (12) Plane the ends. (13) Cut round holes in them, Fig. 573, for the dowel-pins of the core-prints to fit into. (14) Turn between centers the core-prints with filleted flanges and dowels attached, Fig. 573.

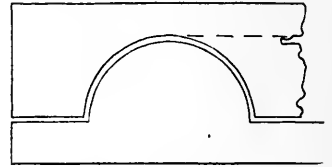

FIG. 574. TEMPLET FOR CONCAVE TURNING.

The curved interior of the core-box for these pipe fittings may be turned upon the face-plate in a manner somewhat similar to that used in turning the pattern. (1) A block at least $1\frac{1}{2}$ " larger than the diameter of the core, and at least $\frac{1}{2}$ " thicker than the radius of the core is affixed to the face-plate. (2) The face of the

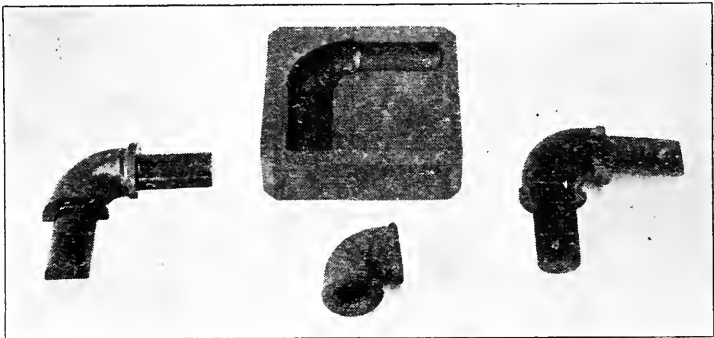
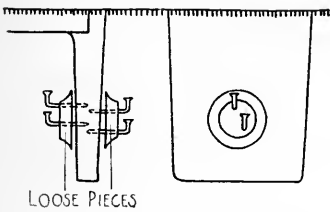

FIG. 575. CORE-BOX, PATTERN OF PIPE FITTING, ELBOW.

block is cut true, and (3) the accurate dimensions laid out upon it. (4) After the depth has been cut with the parting tool, (5) cut the concave form, testing as the turning proceeds by means of a convex templet, Fig. 574, which has been prepared for this purpose. (6) Cut

the box up into as many parts as may be required and join the straight boxes to these properly, strengthening the whole box by joining a board to the back of it, Fig. 575.



LOOSE PIECES

FIG. 576. LOOSE PIECE PATTERNS.

295. **Loose Pieces.**—Many patterns could not be drawn from the mold without some of the parts or pieces being left loose. These loose pieces, Fig. 576, are held in place by a few loose nails or by

dowels to aid the molder in making an easy draw from the mold. If the part were to be made solid as a part of the pattern the mold would be torn up as the pattern is drawn from it.



FIG. 577. LOOSE PIECE PATTERNS.

Should it happen that loose pieces do not aid the molder in getting the required shape of casting, a core-print, Fig. 546, is affixed to the pattern properly and that part of the casting cored out. The molder may well be consulted as to whether the projecting part should be cored or made loose. In such work as casting machine ways, the machinist should be consulted as to whether the projecting part shall be made loose or be given a good draft, Fig. 577.



FIG. 578. USING A BURNING IRON.

296. **Burning Iron.**—Small holes are given draft and smooth sides thru the use of burning irons, Fig. 578.

297. **Affixing Letters or Numerals.**—Names or numbers should be placed upon a pattern as far as possible where

they will not interfere with the drawing of the same, on the side which is opposite the parting line, especially on the drag face where the mold will be free of floating sand.

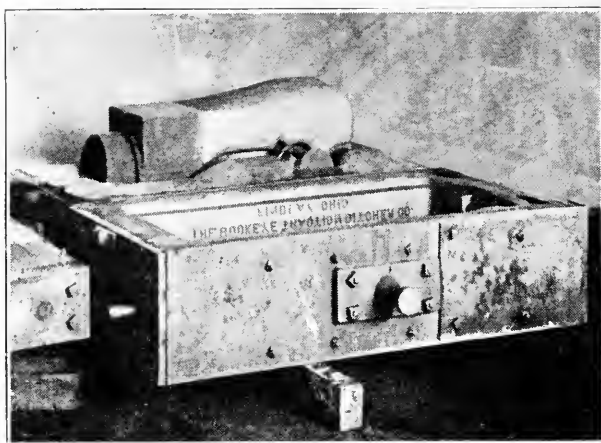

FIG. 579. LETTERING PLACED ON DRAFT.

If the name or numerals must be placed upon draft, Fig. 579, this may be accomplished by attaching the letters or numerals to a loose piece. Fig. 580 shows type of letters suited to pattern work.

298. Varnishing Patterns.

—Patterns are varnished that the moisture of the molding sand may not affect their shape or injure the joints. Copal varnish is best, but, owing to the length of time it requires in drying, shellac is used instead, almost universally. Varnish leaves the pattern

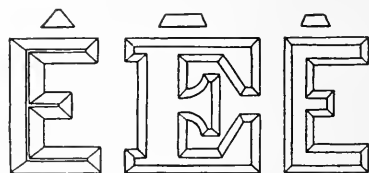

FIG. 580. PATTERN LETTER STYLES.

with a smooth, hard surface which makes drawing from the sand easier than would be the case with the bare wood.

Coloring matter is added to the shellac for two reasons : it gives to the molder a means of determining the kind of metal in which the pattern is to be cast, and helps him to distinguish the purposes of the various parts to the pattern.

There is no hard and fast rule as to the kind of color to be used, but a common practice is to color the orange shellac with lampblack for patterns to be cast in iron. Core-prints will be left natural, altho sometimes they are colored by using shellac mixed with Chinese vermilion. Patterns to be cast in brass are usually painted red with either natural orange or black shellac core prints.

INDEX.

[Numbers Refer to Pages]

A

Adjustments on Surfacers.... 93
Angular Boring Attachment 52
Angular Measurement182
Ash 14
Assembling the Sections284
Automatic Hand Drill 53
Awls 54

B

Babbiting Bearings145
Backing for Face-Plate205
B a n d i n g, Directions for
 Building up a Typical219
Band-Saw111
 Automatic Filing and Fit-
 ting Outfit115
 Fitting and Filing a114
 Operation of111
 Resawing Attachment for
 113
 Ripping Fence113
 Saw Guides114
Basswood 15
Beads, Turning200
Beam Compass 36
Belt Drives145
 Hooks138
 Lacing139, 141, 142
 Preliminary Stretching ..142
 Punch 61
Belting, Formulæ144
 Strength of143

Bevel Gears348
Birch 16
Bit, Extension 52
Blind Mortise-and-Tenon ...166
Blow Torch, Brazing with ..116
Board Measure Table, Essex 27
Boring Machine, Operation of
 a119
 Post119
Boring Machines118
Brace Measure Table 26
Brazing Clamp115
Brazing Small Band-Saws..115
Breast Drill 52
Brush, Directions for Using..241
Brushes239
Burning Iron355
Burnisher 70
Butternut 16
Butt Gage 33

C

Calculating Speeds and Dia-
meters of Pulleys, Saws,
 Grindstones, Etc.149
Calipers 36
Cane Seating315
Carcase Construction300
Carver's Punch 42
Carving, General Directions..223
 Tools 42
Cauls273
Cedar 12
Centering Stock185

Chair, Attaching Rockers ...	270	Core-Box Plane	49
Bending Back Slat	270	Stop-Off	340
Marking Legs for		Core Oven	326
Length	269	Cores and Core-Prints, Ver-	
Seat Frame	267	tical	337
Chairs	267	Cores, Balanced	339
Cheek	321	Dry-Sand	336
Cherry	16	Green-Sand	335
Chestnut	17	Horizontal	338
Chisel, Butt	38	Stop-Off	339
Corner	38	Core, Segmental	272
Mortise	38	Corner Fastenings	265
Chucks; Their Use	208	Corner, Reinforced	265
Circular Miter Saws	107	Coupling, Flexible	150
Plane	42	Cover, Muslin	308
Saws	94	Cross-Lap	156
Circular Saw, Gumming ...	109	Cross-Lap Joint, Directions	
Jointing Teeth	109	for	156, 158
Setting Stake for	108	Curved Work	272
Single Arbor	94	Cut-Off Gage, Miter	99
Universal	94	Cutter Heads: Set Up and	
Clamp, Brazing	115	Fitment of Knives	83
Clamping Framed Structures.	279	Cutting Grooves	293
Irregular Posts	265	Cutting Off; Use of Parting	
Single Arbor	94	Tool	193
Miters	286	Cutting Speed, Rule for ...	149
Table Tops	278	Cutting Tenons with Univer-	
Clamps, Adjusting the	281	saw	100
Clearance Block	101	Wedges on Circular Saw.	103
Cleats	301	Cypress	13
Classification of Woods	11		
Combination Square	35	D	
Concave Cuts, Turning	201	Dado	155
Conifer	11	Directions for	155
Convex and Concave Scrap-		Plane	44
ing	207	Deciduous	12
Convex Cuts, Long	202	Designing, Furniture	255
Short	200	Die, Belt Splicing, for Sand-	
Cope	321	ed Belt	130
Coped Joint	180, 184	Dovetail Corner, Directions	
Core-Box Cutter	120	for	289

- Dovetail Joint171
 Directions for172
 Doweled Joint183
 Doweling161
 Directions for162
 Dowel Marker183
 Plate161
 Drag321
 Drawer Construction288
 Drawer, Directions for291
 Runners and Guides287
 Drawing-Knife 51
 Duplicate Parts, Laying Out.153
 Marking154
 Dust Exhaust System147
- E**
- Elbow Offset; Return Bend..353
 Elm 17
 Emery Wheel Dresser 62
 Endogen 11
 Evergreen 12
 Exogen 11
 Expansion Bit 51
- F**
- Face-Plate and Chuck Work.202
 Face-Plates; Preparation of
 Stock203
 Fasteners, Corrugated350
 Fastening Tops286
 Feed Rolls, Sectional 89
 File, Auger Bit 60
 Cleaner 61
 Files and Rasps 55
 Files, Flat Bastard 59
 Half-Round 59
 Round 59
 Slim Taper 58
 Square 58
- Files, Blunt Band 58
 Mill 58
 The Cuts of 60
 Fillers242
 Fillet Cutter120
 Fillets333
 Filling with Paste Filler243
 Finish, Metals329
 Finishes, Dull250
 Polished250
 Gloss250
 Egg-Shell Gloss249
 Typical249
 Finishing Inlays223
 Carvings237
 Fitting a Door295
 Fitting and Filing Circular
 Saws108
 Flasks320
 Flat Groover120
 Flowing Copal Varnish249
 Forming Arms344
 Forstner Auger Bit 63
 Frieze299
 Fuming245
 Furniture Construction254
- G**
- Gates, Pattern325
 Gear Speed, Rule for151
 Glass Cutter 55
 Glue Joint158
 Directions for158
 Planing Edges for159
 Testing160
 Glue Pots 75
 Grinder, Automatic135
 Grinding136
 Grooving, and Dado or Gain-
 ing Heads for Universal
 Saws105

Grounding Out and Mold- ing	229	A Saw	64
Guard, Shaper	126	A Surface	86
Guards, Band-Saw	112	Joints, Additional	173
Jointer	87	Beaded	180
Saw	96	Bevel-Shoulder	179
Gum Wood	18	Butt	174
		Double Mortise-and-Ten- on	176
		Dovetail Dado	178
		D o v e t a i l Mortise-and- Tenon	177
		Doweled Butt	174
		Draw Bolt	174
		Drawer Corner	180
		End Lap	175
		Fished	178
		Fox Tail Tenon	176
		Gained	175
		Glued and Blocked	174
		Lapped and Strapped	178
		Lapped Dovetail	175
		Ledge and Miter	177
		Ledge or Rabbet	175
		Matched	180
		Middle Lap	175
		Pinned Mortise-and-Ten- on	176
		Rabbeted and Fillistered	180
		Scarf	178, 179
		Slip	176
		Splice	178, 179
		Spline Miter	177
		Stretcher	177
		Stub Mortise-and-Tenon	176
		T h r u Mortise-and-Ten- on	175
		Thrust	179
		Toe Nailed	174
		Tusk Tenon	177
		W e d g e d Mortise-and- Tenon	176
H			
Hammer, Gimp	306		
Hand Drill	53		
Handled Scraper	49		
Hand Planer, Electric Grind- er for	85		
Jointer for	84		
Jointing and Setting At- tachment	85		
Or Jointer	80		
Hardwoods	12		
Haunched Mortise-and-Tenon	293		
Hickory	19		
Hinging a Door	296		
Hopper Joint	181		
Hundredths Scale	28		
I			
Inlaying; General Considera- tion	215		
Inlays of Irregular Outline	215		
J			
Joinery	152		
General Directions for	152		
Jointer, Depth Gage for	85		
Guard	87		
Knives; Testing for Position	84		
Jointing an Edge	86		

K

- Kerfing a Cove for Molding
or Core-Box103
Key, Directions for163
Keyed Tenon-and-Mortise...163

L

- Lacing, Wire138
Lap Joint for Six-Arm Pat-
tern343
Large Gouge, Use of188
Large Skew, Use of191
Lathe126
Counter Shaft126
Motor Head Driven ...127
Position of Operator ..188
Under Driven127
Laying off Consecutive
Measurements198
Laying Out Arms344
Layout, Making330
Letters or Numerals, Affix-
ing355
Light and Shade, Carving...235
Line Carving225
Locks298
Lumberman's Board Stick... 37

M

- Making a Layout330
Mandrel Work, Turning ...211
Maple 20
Marquetry, Directions for ..221
Miter-Box134
Miter Gage, Universal100
Miter Joint170
Clamping170
Directions for170
Nailing 171
Miter Plane and Chute Board
134

- Miter, Sawing99, 100
Square 35
Modeling74, 234
Moldings305
Molding Board322
Operations321
Sand326
Molding, Used in Carving...231
Mortise, Directions for165
Directions for Cutting
168, 169
Directions for Laying
Out167
Gages 33
Mortise in the Tenon, Di-
rections for165
Mortiser119
Mortiser, Operation of a Hol-
low Chisel121
Mullion295

N

- Nail Puller 54
Nails, Ornamental310
Needle, Caning317
For Reed Weaving312
Nut Angers 51

O

- Oak 20
Octagon Scale 25
Odontograph348
Oil or Copal Varnishes248
Operating a Swing Cut-Off
Saw 80
Operation of a Surfacr 90
Of Hand Planer 85
Order of Procedure in Use
of Machines 77
Outside Calipers, Use of ...190

P

Painting	251
Paneling	292
Panel, Placing Glass	295
Parting, Molding	323
Patching	250, 271
Pattern, Determining Factors in the Construction of	325
Draft	326
Pattern-Maker's Gage	34
Knife	38
Pattern-Making	320
Order of Procedure	332
Materials	320
Period Furniture	303
Adam	305
Chippendale	304
Elizabethan	304
Gothic	303
Hepplewhite	304
Jacobean	304
Louis XVI	303
Mission	305
Queen Anne	304
Renaissance	303
Sheraton	304
Victorian	305
Picture Frame Miter-Box and Nailing Clamp	135
Pierced Ornamentation	237
Pilaster	299
Pine	13
Pinned Mortise-and-Tenon	183
Pitch, Roof	29
Planer or Surfacers	88
Planing Device	86
Plinth	299
Plow and Matching Plane	46
Plug Cutter	61
Plumb and Level	32

Posts or Legs	262
Power Transmission	137
Pulley Speeds, Rules for	149

R

Rabbet and Filletster Plane ..	44
Rabbeted Corner, Directions for	289
Rabbeting	294
Rabbet or Rebate Plane	43
Rafter Cuts	30
Rafter, Hip	30
Jack	31
Length, Determining	32
Rise	29
Run	29
Table	29
Valley	30
Rail, Door	295
Rapping	324, 328
Recipes, Wood Finishing	252
Regulator, Upholstery	306
Ribbon Carving	227
Carving, Laying Out for	228
Ring, Turning a	208
Rods, Furniture Construction	302
Rough Scraping, Turning	206
Router Plane	48
Rule, Flexible Folding	24
Pattern-Maker's Shrink- age	24
Rush Fiber Seat	312

S

Safety Cutter Heads	83
Sander, Disc and Spindle	131
Drum	128
The Belt	129
Sanders	128

- Sandpapering and Finishing,
 Turning212
- Saw Clamp 66
 Jointer 64
 Set 65
- Scraper Plane 48
- Scraping Tools, Turning ... 40
- Scratch Stock220
- Screw and Plug Bit 61
- Scribing Posts285
- Scroll Saw117
- Seat, Caned318
 Slip310
- Seating, Fiber314
- Seats, Reed313
- Segments, Pattern342
- Selection of Belting143
- "Setting-Up" a Hand Planer 80
- Shaper125
- Shaper Collars and Cutters..125
- Shaft Drive vs. Individual
 Motor Drive148
- Sharpening Auger Bits 62
 Carving Tools 73
 Lathe Tools 71
 Saws 64
 Scrapers 70
- Shellac247
 Finishes248
 Orange247
 White247
- Shelving301
- Shrinkage327
 Double328
- Shrinkage vs. Rappage328
- Skew or Turner's Chisel 39
 Use of Heel of the197
 Use of Toe of the195
- Slats; Splats or Splads;
 Balusters265
- Softwoods 12
- Speed Indicator150
- Speed, Rule for151
 Rules for Cutting149
 Rule for Pulley149
- Sphere, Turning211
- Spiral Screwdriver 54
- Splicing Belts138
- Split Patterns, Dowels349
- Spring or Box Seat310
- Springs311
- Spruce 14
- Sprue Pin323
- Spur Gear Teeth347
- Square, Framing 25
- Stains244
 Fumed245
 Oil 245
 Spirit245
 Water245
- Stile, Door295
- Stretcher299
- Strings and Bandings218
 Directions for Laying ..219
- Structural Details260
- Superposition153
- Surfacer, Jointer for 84
 Jointing and Setting At-
 tachment for 85
- Surface Table 75
- Surfacing Table Tops279
- Swing Cut-Off Saw 78
- Sycamore 22

T

- Table for Set-Up of Univer-
 sal Saw for Compound
 Miters105
- Taper Cuts, Long197
- Tee-Pipe Fittings351
- Templets303

CORRELATED COURSES IN WOODWORK AND MECHANICAL DRAWING

By IRA S. GRIFFITH

Chairman of the Manual Arts Department, The University of Missouri.

A handbook on organization, lesson outlines and methods of teaching. It is designed to meet the every-day need of the teacher of woodworking and mechanical drawing for reliable information concerning organization of courses, subject matter, and methods of teaching. It covers classification and arrangement of tool operations for grades 7, 8, 9 and 10, shop organization, allotment of time, design, shop excursions, stock bills, cost of material, records, shop conduct, the lesson, maintenance, equipment, and lesson outlines for grammar and high schools. It is based on sound pedagogy, thoro technical knowledge and successful teaching experience, and is extremely practical. For the convenience of teachers, the drawings used in "Projects for Beginning Woodwork and Mechanical Drawing" and "Advanced Projects in Woodwork," are printed in this book. It is considered the most comprehensive treatment of the subject of teaching woodworking ever published.

238 pages, 100 full page plates of working drawings.

PRICE, POSTPAID, \$1.50.

ESSENTIALS OF WOODWORKING

By IRA S. GRIFFITH

Chairman of the Manual Arts Department, The University of Missouri.

A textbook written especially for grammar and high school students. A clear and comprehensive treatment of woodworking tools, materials, and processes, to supplement, but not to take the place of the instructions given by the teacher. The book does not contain a course of models; it may be used with any course. It is illustrated with photographs and numerous pen drawings.

TREATS OF

- | | |
|--|---|
| I Laying out Tools, Their Uses | VIII Type Forms |
| II Saws | IX Elementary Cabinet Work |
| III Planes | X Wood |
| IV Boring Tools; Boring | XI Lumbering and Milling |
| V Chiseling | XII Common Woods |
| VI Form Work; Modeling | XIII Wood Finishing |
| VII Laying Out Duplicate Parts;
Scraping and Sandpapering,
Fastening Parts | Appendix—Additional Joints, Wood
Finishing Recipes — Working
Drawings |

THE STANDARD TEXTBOOK ON ELEMENTARY WOODWORKING

PRICE, POSTPAID, 75 CENTS.

THE MANUAL ARTS PRESS

PEORIA, - - - - ILLINOIS

PROJECTS FOR BEGINNING WOODWORK AND MECHANICAL DRAWING

By IRA S. GRIFFITH

Chairman of the Manual Arts Department, The University of Missouri.

A book of problems for the use of grammar grade pupils. It consists of working drawings and working directions. The projects are such as have proven of exceptional service where woodworking and mechanical drawing are taught in a thoro, systematic manner in the seventh and eighth grades. The aim has been to provide successful rather than unique problems. The 50 projects in the book have been selected and organized with the constant aim of securing the highest educational results. The book is especially suited for use in connection with "Essentials of Woodworking" by the same author.

PRICE, POSTPAID, 75 CENTS.

FURNITURE MAKING

ADVANCED PROJECTS IN WOODWORK

By IRA S. GRIFFITH

Chairman of the Manual Arts Department, The University of Missouri.

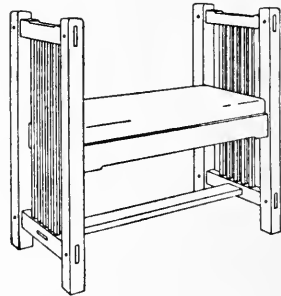
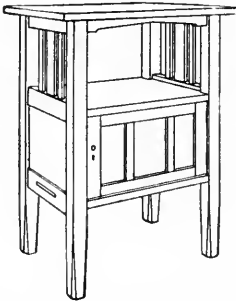

A book of problems for the use of high school pupils. It consists of fifty plates and accompanying notes. It is essentially a collection of problems in furniture making, selected or designed with reference to school use. On the plate with each working drawing is a good perspective sketch of the completed object. In draftsmanship and refinement of design these problems are of superior quality. *It is in every way an excellent collection and is sure to establish a high standard in any school where it is used with reasonable intelligence.*

PRICE, POSTPAID, 75 CENTS.

CARPENTRY

By IRA S. GRIFFITH

Chairman of the Manual Arts Department, The University of Missouri.

A well illustrated textbook for use in vocational schools, trade schools, technical schools and by apprentices to the trade, presenting the principles of house framing in a clear and fundamental way. An admirable combination of practical experience and constructive principles. In preparation.

THE MANUAL ARTS PRESS
PEORIA, - - - - ILLINOIS

Books on the Manual Arts

DESIGN AND CONSTRUCTION IN WOOD. By Noyes.

A book full of charm and distinction. It illustrates a series of projects and gives suggestions for other similar projects, together with information regarding tools and processes for making. A pleasing volume abundantly and beautifully illustrated. \$1.50.

HANDWORK IN WOOD. By Noyes.

A comprehensive and scholarly treatise, covering logging, saw-milling, seasoning and measuring, hand tools, wood fastenings, equipment and care of the shop, the common joints, types of wood structures, principles of joinery, and wood finishing. 304 illustrations—excellent pen drawings and many photographs. The best reference book available for teachers of woodworking. \$2.00.

WOOD AND FOREST. By Noyes.

A reference book for teachers of woodworking. Treats of wood, distribution of American forests, life of the forest, enemies of the forest, destruction, conservation and uses of the forest, with a key to the common woods by Filibert Roth. Describes 67 principal species of wood with maps of the habitat, leaf drawings, life size photographs and microphotographs of sections. Profusely illustrated. \$3.00.

MANUAL ARTS FOR VOCATIONAL ENDS. By Crawshaw.

A strong and convincing plea for the development of the present school machinery to serve the ends of vocational education. It treats the problem in a practical way, giving concrete working helps, and is a source of inspiration to manual arts teachers and others interested in the problem. 85 cents.

HANDWORK INSTRUCTION FOR BOYS. By Pabst.

A philosophical and historical review of manual training for boys and a discussion of the systems in vogue in the several European countries and in America, by the director of the normal school for teachers of manual training at Leipsic. \$1.00.

HANDCRAFT IN WOOD AND METAL. By Hooper and Shirley.

A valuable reference book on craftwork in wood and metal. It treats of historic craftwork, materials used in handicrafts, designing, decorative processes, the historic development of tools, the theory of the cutting action of tools, and the equipment of the school workshop. \$3.00.

WOOD PATTERN-MAKING. By Purfield.

A clear, concise treatise on the fundamental principles of pattern-making. It presents the best methods of construction and those most easily understood by the student. A practical text for the high school, trade school, technical school and engineering college students. New edition \$1.00.

BEGINNING WOODWORK. By VanDeusen.

A valuable textbook for rural schools, by one who has made a special study of the manual training problems in the country school. A full and clear description in detail of the fundamental processes of elementary benchwork in wood. \$1.00.

FURNITURE DESIGN FOR SCHOOLS AND SHOPS. By Crawshaw.

A manual on furniture design containing a collection of plates showing perspective drawings of typical designs, representing particular types of furniture. Each perspective is accompanied by suggestions for rearrangements and the modeling of parts. The text discusses and illustrates principles of design as applied to furniture. Should be in the hands of every teacher of cabinet making and designing. \$1.00.

PROBLEMS IN WOODWORKING. By Murray.

A collection of forty plates of working drawings of problems in bench work that have been successfully worked out by boys in grades from seven to nine, inclusive. 75 cents.

THE MANUAL ARTS PRESS
PEORIA, - - - - - ILLINOIS

Books on the Manual Arts

PROBLEMS IN FARM WOODWORK. By Blackburn.

A book of working drawings of 100 practical problems relating to agriculture and farm life. Each problem is accompanied by text treating of "Purpose," "Material," "Bill of Stock," "Tools," "Directions," and "Assembly." Of special value to the pupil and teacher of agriculture and manual arts in rural schools, and to the boy on the farm. \$1.00.

PROBLEMS IN FURNITURE MAKING. By Crawshaw.

Contains 43 full-page working drawings of articles of furniture. In addition to the working drawings, there is a perspective sketch of each article completed. There are 36 pages of text giving notes on the construction of each project, chapters on the "Design," and "Construction" of furniture, and one on "Finishes." The last chapter describes 15 methods of wood finishing, all adapted for use on furniture. \$1.00.

PROBLEMS IN WOOD-TURNING. By Crawshaw.

Contains 25 full-page plates of working drawings covering spindle, face-plate, and chuck turning. It gives the mathematical basis for the cuts used in turning. A valuable textbook for students' use. 80 cents.

WORKSHOP NOTE-BOOK—WOODWORKING. By Greene.

A note-book which furnishes a few general and extremely important directions about tools and processes; and provides space for additional notes and working drawings. It is essentially a collection of helps, ideas, hints, suggestions, questions, facts, illustrations, etc. The note-book is full of suggestions; shows a keen insight into subject matter and teaching methods and is an effective teaching tool. 15 cents.

MANUAL TRAINING TOYS FOR THE BOY'S WORKSHOP.

By Moore.

A popular boy's book. It contains 35 pages of full-page plates of working drawings illustrating 42 projects. All the projects are overflowing with "boy" interest, and are well adapted to the upper grades of the elementary school. The text treats of tools and tool processes and gives instructions for making each project. \$1.00.

KITECRAFT AND KITE TOURNAMENTS. By Miller.

Authoritative and comprehensive. The book deals with the construction and flying of all kinds of kites, and the making and using of kite accessories. Also aeroplanes, gliders, propellers, motors, etc. Abundantly illustrated and attractively bound. \$1.00.

PROBLEMS IN MECHANICAL DRAWING. By Bennett.

A students' textbook consisting of 80 plates of problems classified into groups according to principle, and arranged according to difficulty of solution. Each problem is given unsolved and therefore in proper form to hand to the pupil for solution. The best collection of problems for first year high school students available. 75 cents.

MECHANICAL DRAFTING. By Miller.

A textbook on mechanical drawing, for advanced high school and first year engineering students. The book abounds in illustrations, both line drawings and half-tones. A practical treatment of subject matter and a students' text easily adaptable to varied schools and conditions. Contains 219 pages and 225 illustrations, and is bound in black flexible leather, pocket size. \$1.50.

SIMPLIFIED MECHANICAL PERSPECTIVE. By Frederick.

A textbook of simple problems covering the essentials of mechanical perspective. It is planned for pupils of high school age who have already received some elementary training in mechanical drawing. It is simple, direct and practical. 75 cents.

BOOKS ON THE MANUAL ARTS

A bibliography, listing and describing over 400 titles, mailed free.

THE MANUAL ARTS PRESS
PEORIA, - - - - ILLINOIS

LIBRARY OF CONGRESS



0 013 824 501 9 ●